

iSMA-B-FCU

User Manual

Quick Start-up

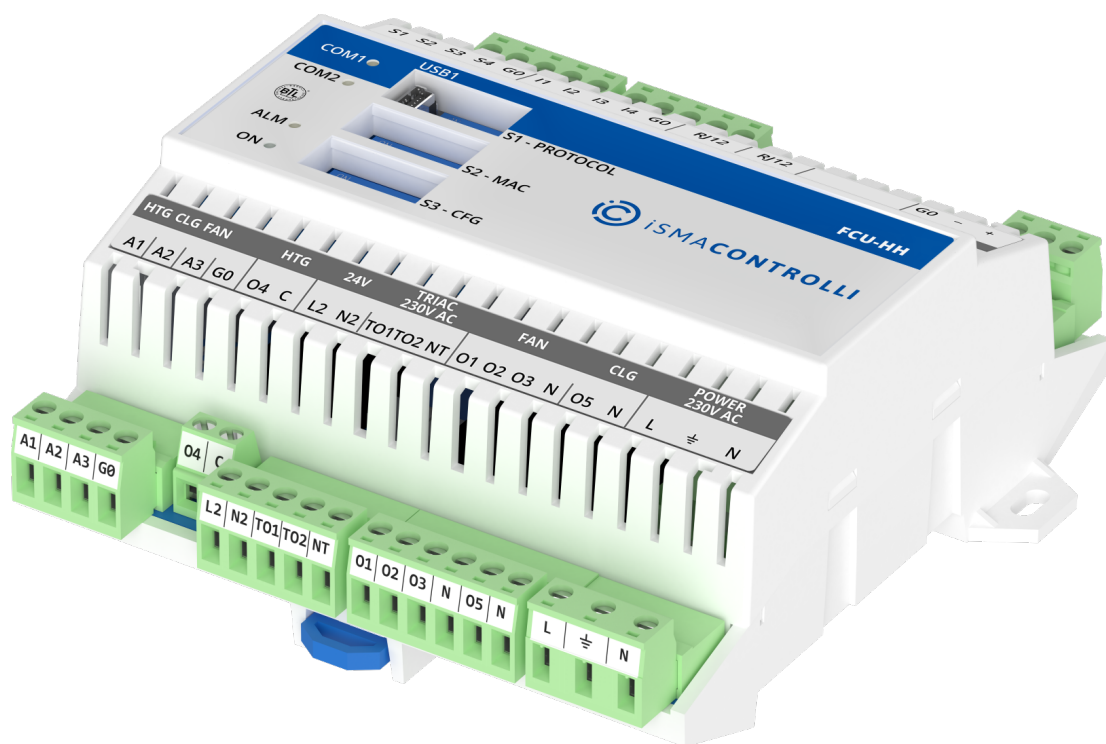

Table of Contents

1	Introduction	4
1.1	Revision History.....	4
2	Overview	5
2.1	Box Contents	5
2.2	Tools	5
2.3	Dimensions and Mounting.....	5
2.4	Technical Specification	5
3	Configuring and Connecting the Controller	6
3.1	Controller Overview	6
3.2	Step 1: Selecting Protocol and Baud Rate; Restoring the Default Settings	7
3.2.1	PROTOCOL DIP Switch Configuration.....	7
3.2.2	Restoring Default Settings.....	8
3.3	Step 2: Setting Controller Address.....	9
3.3.1	MAC DIP Switch Configuration	9
3.4	Step 3: Choosing the FCU Pipe Type	10
3.4.1	4-Pipe Heating and Cooling	10
3.4.2	2-Pipe Only Heating or Only Cooling	11
3.5	Step 4: Switching Between 1 Heating Stage and 2 Heating Stages Modes.....	12
3.5.1	2 Stages of Heating in 4-Pipe Fan Coil Unit.....	13
3.6	Step 5: Switching Between 1 Cooling Stage and 2 Cooling Stages Modes.....	13
3.6.1	2 Stages of Cooling in 4-Pipe Fan Coil Unit	13
3.7	Step 6: Selecting Type of Control Required by the FCU Valves and Connection Details.....	14
3.8	Step 7: Selecting the Temperature Control Value Source and its Connection Details.....	16
3.8.1	Temperature Source: iSMA-B-LP/Touch Point/FP Room Panel.....	16
3.8.2	Temperature Source Connected to S3	16
3.8.3	Temperature Source Connected to S1	17
3.8.4	Temperature Source Connected to RS485 Network.....	17
3.9	Step 8: Selecting Type of Fan Used Within the Project and its Connection Details ...	18
3.9.1	Analog Controlled Fan Connection	18
3.9.2	1-speed Fan Connection.....	18
3.9.3	2-speed Fan Connection.....	19
3.9.4	3-speed Fan Connection.....	20
4	Examples: Connecting Actuators and Sensors to the Controller	22

4.1	Connections Overview.....	22
4.2	Connection Examples.....	22
4.2.1	4-pipe Installation with 1-stage Digital Controlled Heating and Cooling and Analog Controlled Fan.....	22
4.2.2	4-pipe Installation with 1-stage Digital Controlled Heating and Cooling and 1-speed Fan.....	23
4.2.3	4-pipe Installation with 1-stage Digital Controlled Heating and Cooling and 2-speed Fan.....	23
4.2.4	4-pipe Installation with 1-stage Digital Controlled Heating and Cooling and 3-speed Fan.....	24
4.2.5	4-pipe Installation with 1-stage Analog Controlled Heating and Cooling and Analog Controlled Fan.....	24
4.2.6	4-pipe Installation with 1-stage Analog Controlled Heating and Cooling and 1-speed Fan.....	25
4.2.7	4-pipe Installation with 1-stage Analog Controlled Heating and Cooling and 2-speed Fan.....	25
4.2.8	4-pipe Installation with 1-stage Analog Controlled Heating and Cooling and 3-speed Fan.....	26
4.2.9	2-pipe Installation with 1-stage Digital Controlled Cooling and Analog Controlled Fan.....	26
4.2.10	2-pipe Installation with 1-stage Digital Controlled Heating and 1-speed Fan.....	27
4.2.11	2-pipe Installation with 1-stage Digital Controlled Cooling and 2-speed Fan.....	27
4.2.12	2-pipe Installation with 1-stage Digital Controlled Heating and 3-speed Fan.....	28
4.2.13	2-pipe Installation with 1 Stage Analog Controlled Cooling and Analog Controlled Fan.....	28
4.2.14	2-pipe Installation with 1-stage Analog Controlled Heating and 1-speed Fan.....	29
4.2.15	2-pipe Installation with 1-stage Analog Controlled Cooling and 2-speed Fan.....	29
4.2.16	2-pipe Installation with 1-stage Analog Controlled Heating and 3-speed Fan.....	30
5	All Configurations for FCU Default Application.....	31

1 Introduction

This manual explains basic procedures for using the controller, setting up the built-in application and information on connection details. It is recommended to read this manual before using the controller. For detailed operating procedures and troubleshooting information, see user manuals: FCU Programming, FCU Application, FCU Hardware, FCU Updater.

1.1 Revision History

Rev.	Date	Description
1.3	19 Jul 2024	Updated information about the default settings (I/O configuration cleared while restoring to default settings)
1.2	21 Feb 2023	<ul style="list-style-type: none"> • Updated information about the default settings (values stored in the EEPROM memory cleared while restoring to default settings) • Updated FP panel references
1.1	21 Apr 2022	<ul style="list-style-type: none"> • Rebranded • Updated Touch Point panel references
1.0	5 Mar 2021	First edition

Table 1. Revision history

2 Overview

2.1 Box Contents

The iSMA-B-FCU controller comes in a box along with the connectors and the iSMA-B-FCU installation instruction.

2.2 Tools

To safely and properly set up the iSMA-B-FCU controller, the flat head screwdriver 3.0 x 0.5 mm is necessary.

2.3 Dimensions and Mounting

The controller dimensions and mounting details are presented on the figure 1. There are no additional requirements for controller's orientation and placement.

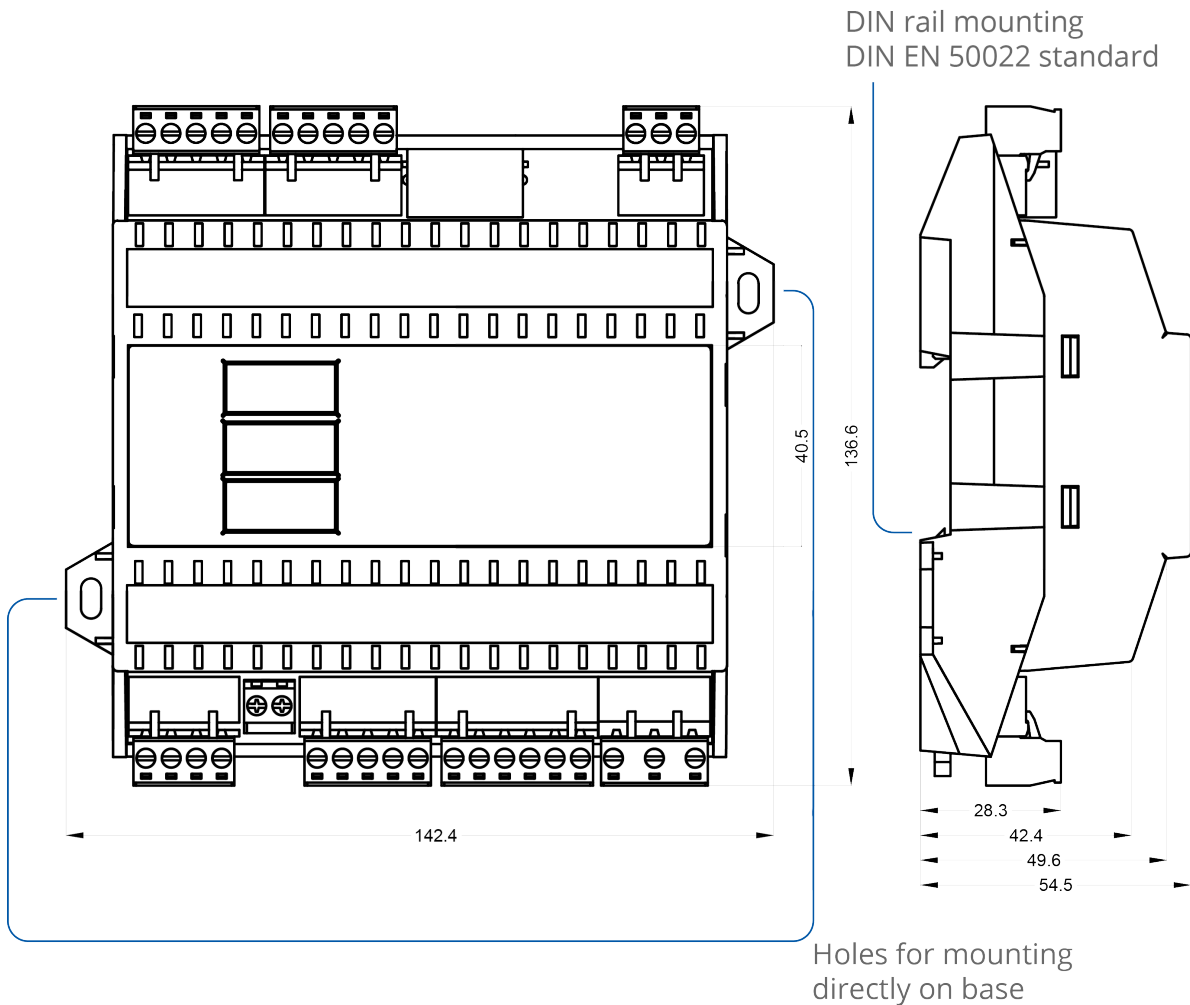

Figure 1. FCU dimensions and mounting

2.4 Technical Specification

For detailed technical specification, see the [FCU Hardware](#) manual.

3 Configuring and Connecting the Controller

3.1 Controller Overview

This section outlines the differences between the FCU hardware versions and describes steps required to properly configure the controller. For further information, please see the [FCU Hardware](#) manual.

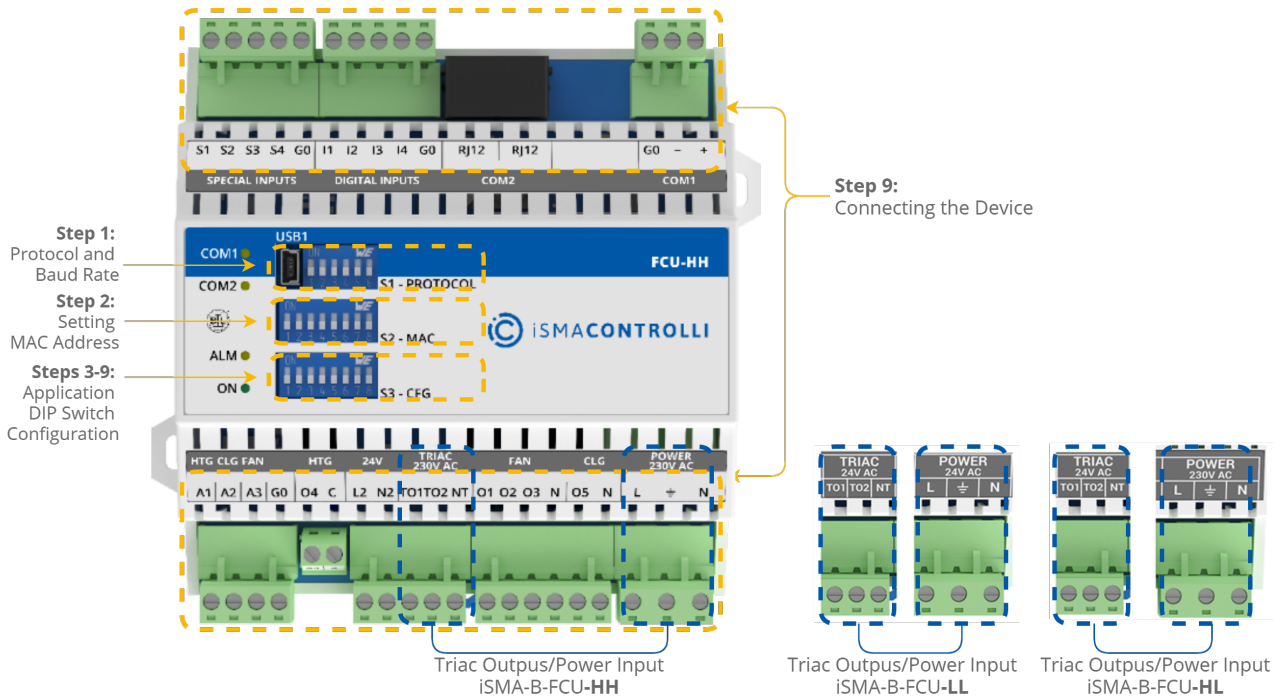

Figure 2. FCU controller HH version; HL and LL versions with different power voltages

The PROTOCOL DIP switch is responsible for configuring the communication protocol.

The MAC DIP switch is responsible for addressing the controller.

The CFG DIP switch is responsible for configuring the application.

Note: The detailed information about the DIP switches configuration is available in the FCU Hardware manual.

The iSMA-B-FCU controller configuration step by step is described in chapter 3 of this document and consists of steps:

- Step 1: Selecting Protocol and Baud Rate; Restoring the Default Settings
- Step 2: Setting Controller Address
- Step 3: Choosing the FCU Pipe Type
- Step 4: Switching Between 1 Heating Stage and 2 Heating Stages Modes
- Step 5: Switching Between 1 Cooling Stage and 2 Cooling Stages Modes
- Step 6: Selecting Type of Control Required by the FCU Valves and Connection Details
- Step 7: Selecting the Temperature Control Value Source and its Connection Details
- Step 8: Selecting Type of Fan Used Within the Project and its Connection Details

Steps 3-8 describe configuration of the CFG DIP switch. Their overview with default positioning is presented in the table below.

No.	Name	On	Off	Default
1	Pipe Mode	2-pipe	4-pipe	4-pipe
2	Heating 2nd Stage	Enable	Disable	Disable
3	Cooling 2nd Stage	Enable	Disable	Disable
4	Heating/cooling control mode	Analog	Digital	Digital

Table 2. The CFG DIP switch configuration

WARNING!

Before attempting to configure the controller, make sure to have acquainted with all the required documentation, or have a good knowledge of the fan coil unit application—this will make configuration of the controller easy-going and trouble-free.

3.2 Step 1: Selecting Protocol and Baud Rate; Restoring the Default Settings

3.2.1 PROTOCOL DIP Switch Configuration

Depending on the communication protocol, used within the network the controller is connected to, there is a possibility to switch the protocol used by the controller so it matches the network protocol.

The protocol, which the controller operates with, and baud rate selection is made with the PROTOCOL DIP switch.

The 1st, 2nd, and 3rd switches are responsible for baud rate, while the 4th and 5th are responsible for the protocol. The 6th switch is responsible for restoring the default settings.

The PROTOCOL DIP switch settings for baud rate and protocol selection are shown in tables below.

1	2	3	Baud Rate
OFF (0)	OFF (0)	OFF (0)	Defined by user
OFF (0)	OFF (0)	ON (1)	76800
OFF (0)	ON (1)	OFF (0)	4800
OFF (0)	ON (1)	ON (1)	9600
ON (1)	OFF (0)	OFF (0)	19200
ON (1)	OFF (0)	ON (1)	38400

1	2	3	Baud Rate
ON (1)	ON (1)	OFF (0)	57600
ON (1)	ON (1)	ON (1)	115200

Table 3. Baud rate configuration

4	5	Protocol
OFF (0)	OFF (0)	Modbus RTU
OFF (0)	ON (1)	Modbus ASCII
ON (1)	OFF (0)	BACnet Master
ON (1)	ON (1)	BACnet Slave

Table 4. Protocol configuration

3.2.2 Restoring Default Settings

To restore the default iSMA-B-FCU device settings, follow the steps below:

- Turn off the power supply.
- Set the 6th switch of the PROTOCOL DIP switch to ON.
- Turn on the power supply, wait until the power LED is blinking.
- Set the 6th switch to OFF to restore the default settings. To cancel the reset, turn off the power supply and set the 6th switch to the OFF position.

Out of the box device, as well as after restoring default values procedure, has the default settings as shown in the table below. All parameters can be changed using the iSMA Tool software with the controller connected, only the baud rate and used protocol can be modified with DIP switches.

Name	Default Value
User baud rate	76800
Stop bits	1
Data bits	8
Parity bit	0
Response delay	0
I1-I4 digital input counters	0
Values stored in the EEPROM memory	Cleared
I/O configuration	Cleared

Table 5. Default values

For more information on changing the protocol parameters, check the FCU Application manual and FCU Hardware manual.

3.3 Step 2: Setting Controller Address

3.3.1 MAC DIP Switch Configuration

For the controller to operate correctly in the network, its address needs to be set to the desired value. The controller address is set by the MAC DIP switch. The state of the MAC DIP switch represents binary information of the controller address. The first 10 addresses and corresponding DIP switch setting is shown below.

Address	S1	S2	S3	S4	S5	S6	S7	S8	MAC DIP Switch Configuration
1	On								
2		On							
3	On	On							
4			On						
5	On		On						
6		On	On						
7	On	On	On						

Address	S1	S2	S3	S4	S5	S6	S7	S8	MAC DIP Switch Configuration
8				On					
9	On			On					
10		On		On					

Table 6. MAC DIP switch configuration

For another address DIP switch configuration, see the iSMA-B-FCU Hardware manual.

3.4 Step 3: Choosing the FCU Pipe Type

The iSMA-B-FCU can be used in 4-pipe installations as well as in 2-pipe installations. In order for the controller to operate correctly in the application, it is necessary to know the fan coil pipe type and set the CFG DIP switch to the corresponding settings as described below.

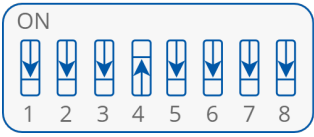
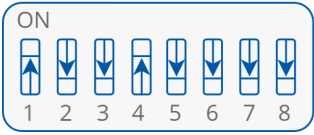
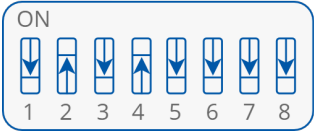
3.4.1 4-Pipe Heating and Cooling

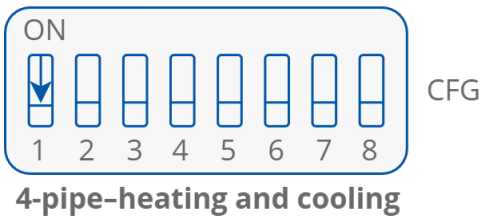

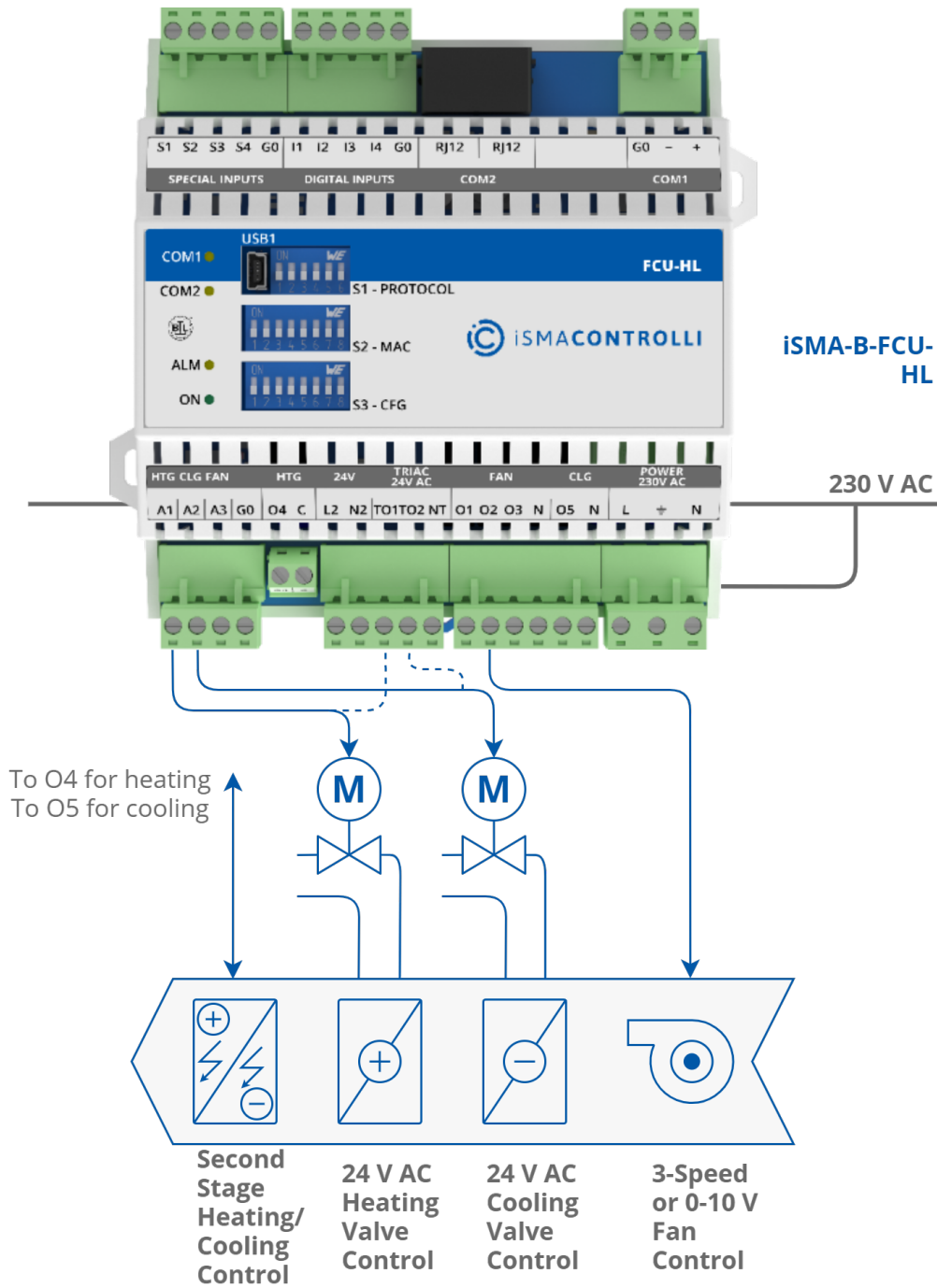
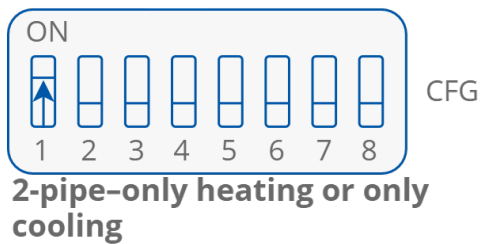

Figure 3. 4-pipe FCU installation

3.4.2 2-Pipe Only Heating or Only Cooling



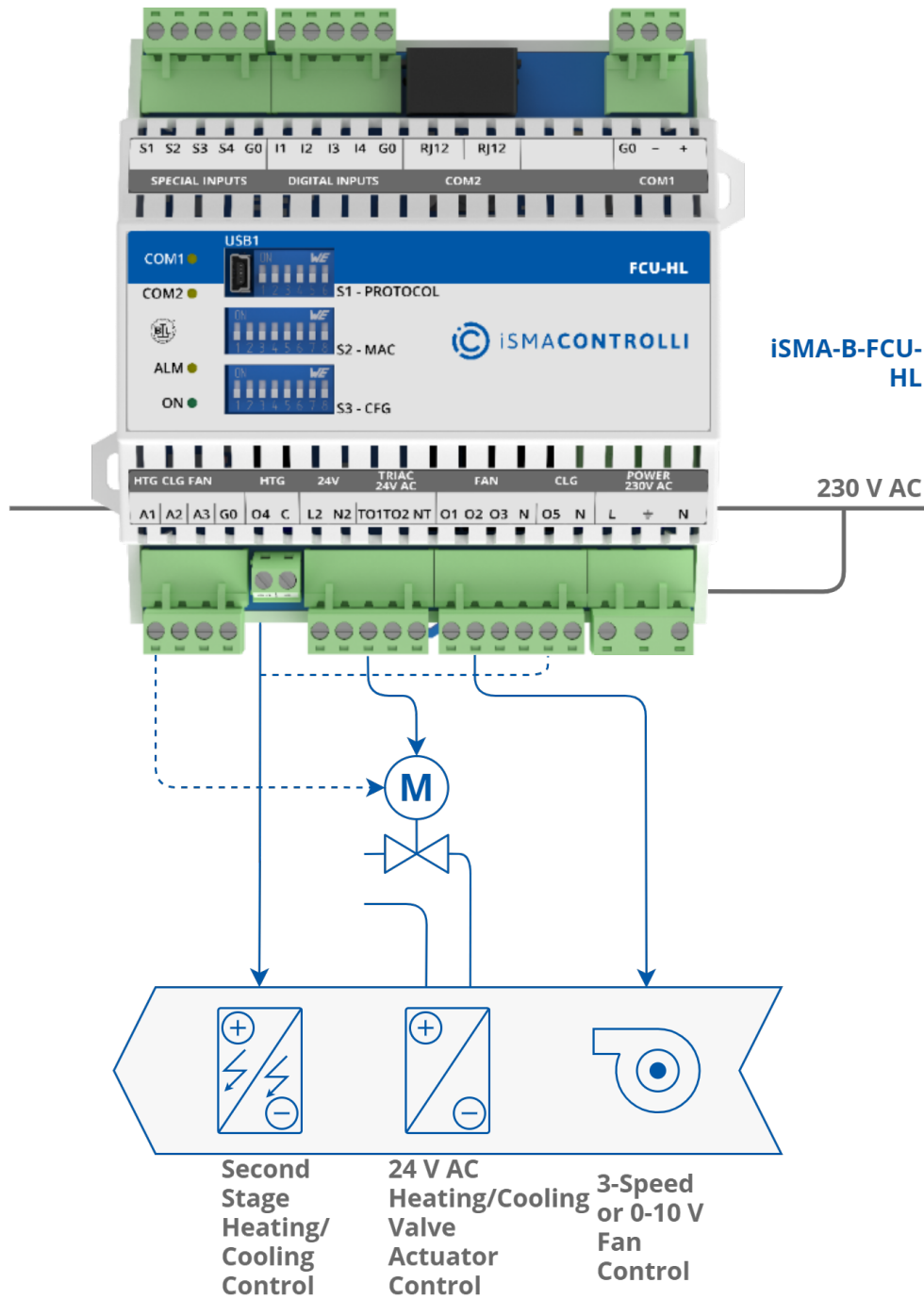

Figure 4. 2-pipe FCU installation

For connection details go to steps 6, 7, and 8.

For more information on configuring the FCU pipe types, check the [FCU Application manual](#).

3.5 Step 4: Switching Between 1 Heating Stage and 2 Heating Stages Modes

The fan coil unit can operate with one heating device or with two heating devices. This needs to be configured with the 2nd section of the CFG DIP switch.

3.5.1 2 Stages of Heating in 4-Pipe Fan Coil Unit

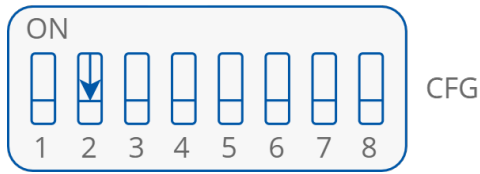

1 stage heating = 1 heating device

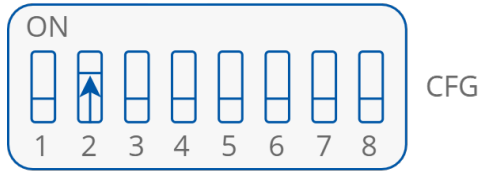

2 stage heating = 2 separate heating devices

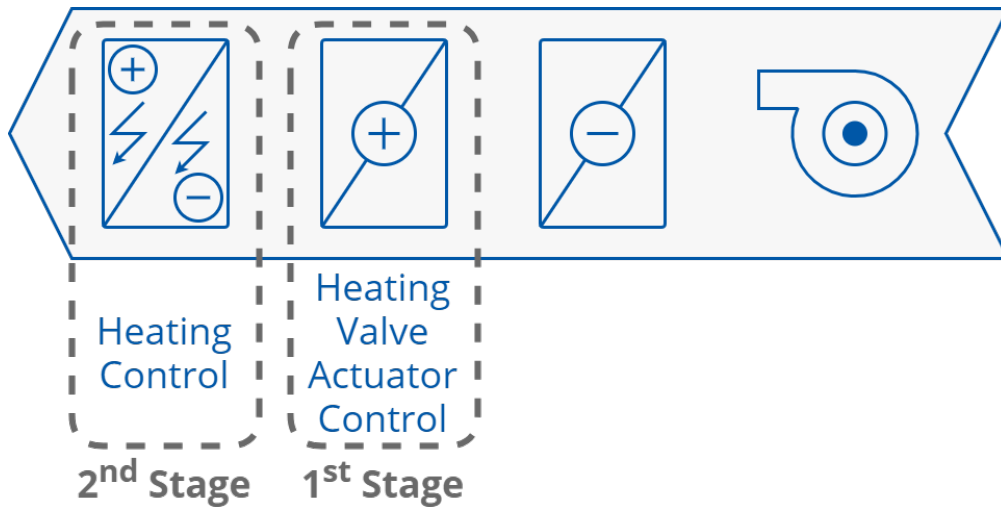

Figure 5. 2 stages of heating in 4-pipe FCU installation

For more information on configuring stages of heating, check the FCU Application manual.

3.6 Step 5: Switching Between 1 Cooling Stage and 2 Cooling Stages Modes

The fan coil unit can operate with one cooling device or with two cooling devices. This needs to be configured with the 3rd DIP switch CFG.

3.6.1 2 Stages of Cooling in 4-Pipe Fan Coil Unit



1 stage cooling = 1 cooling device

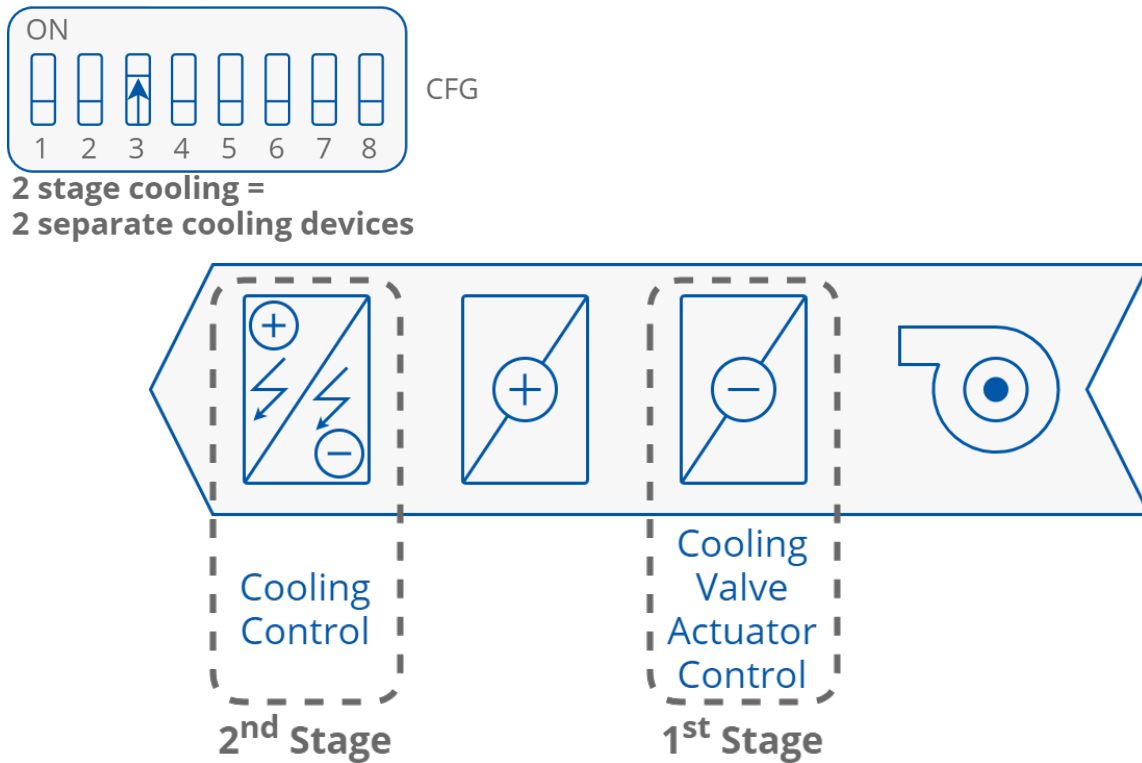
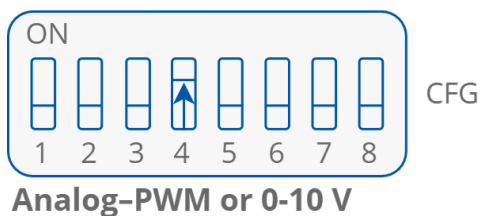
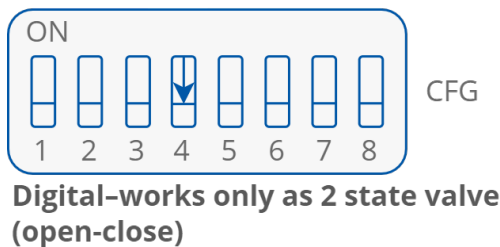

Figure 6. 2 stages of cooling in 2-pipe FCU installation

For more information on configuring stages of cooling, check the FCU Application manual.

3.7 Step 6: Selecting Type of Control Required by the FCU Valves and Connection Details

The controller’s outputs can operate in digital or analog mode. Depending on the fan coil unit actuators control type, the corresponding DIP switch has to be set to a desired position.



The figure below pictures the connection of heating actuators:

- A1 for analog 0-10 V control;
- TO1 for analog PWM or digital ON-OFF control;
- O4 for digital ON-OFF control.

Note that, when using the second stage heating, the additional second stage heater can be controlled only by the O4 output, leaving the A1 or TO1 for the first stage. Otherwise, when using only the first stage heating, the O4 output can be used for digital control of the first stage heating actuator.

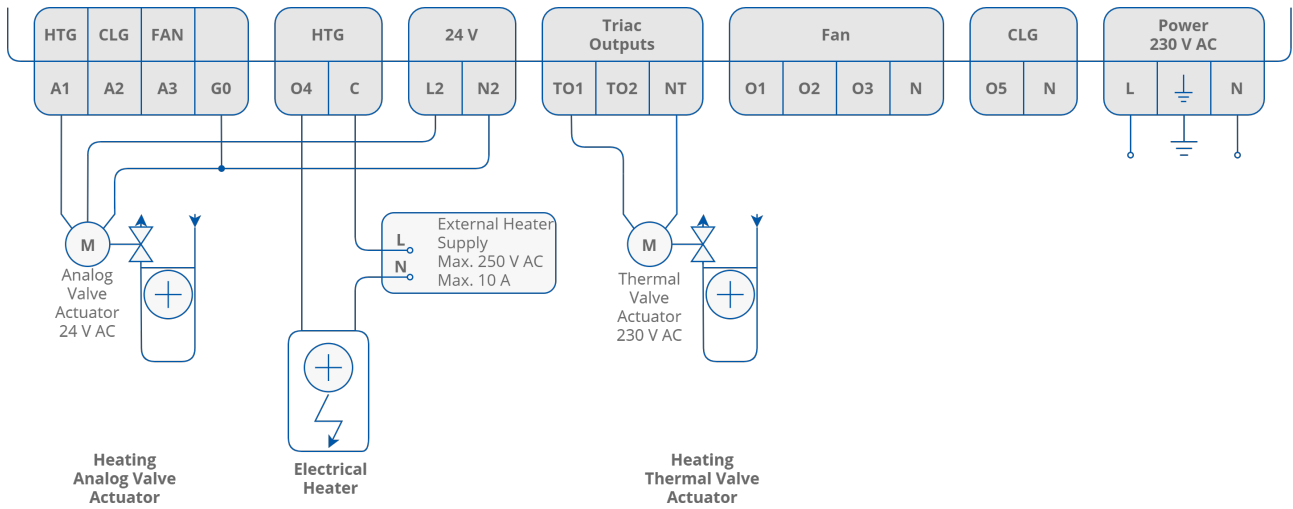

Figure 7. Heating actuators connection

The figure below pictures the connection of cooling actuators:

- A1 for analog 0-10 V control while operating in 2-pipe mode;
- A2 for analog 0-10 V control while operating in 4-pipe mode;
- TO1 for analog PWM or digital ON-OFF control while operating in 2-pipe mode;
- TO2 for analog PWM or digital ON-OFF control while operating in 4-pipe mode;
- O5 for digital ON-OFF control.

Note that, when using the second stage cooling, the additional second stage cooler can be controlled only by the O5 output, leaving the A1, A2, TO1, or TO2 for the first stage. Otherwise, when using only the first stage cooling, the O5 output can be used for digital control of the first stage cooling actuator.

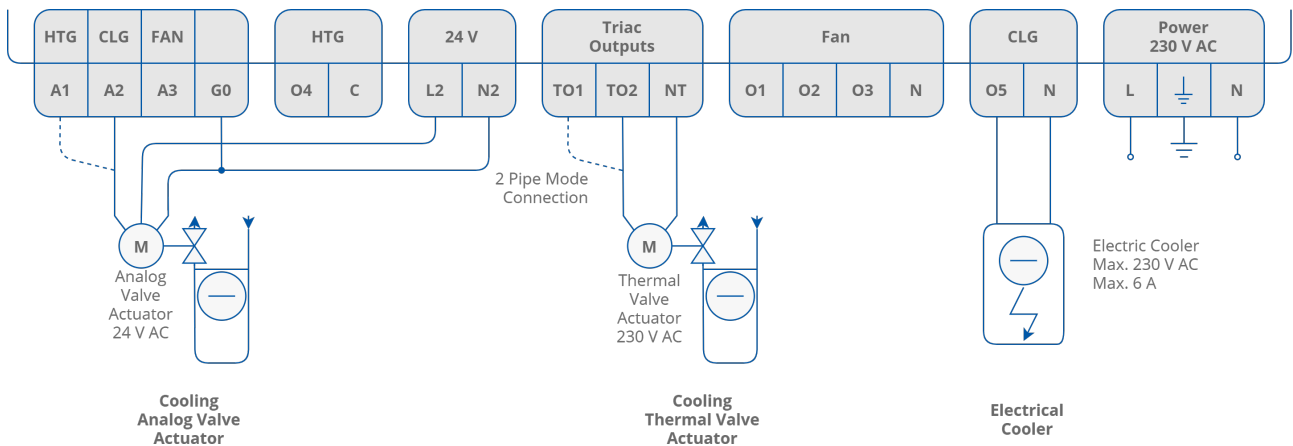

Figure 8. Cooling actuators connection

For more information on control types and connection details, check the [FCU Application manual](#) and [FCU Hardware manual](#).

3.8 Step 7: Selecting the Temperature Control Value Source and its Connection Details

The temperature control value source has to be specified with the DIP switches 5 and 6. By default, the sensor's type, served by the controller's inputs S1 and S3, is the 10K3A1 NTC.

The temperature sensor type can be changed using the iC Tool software.

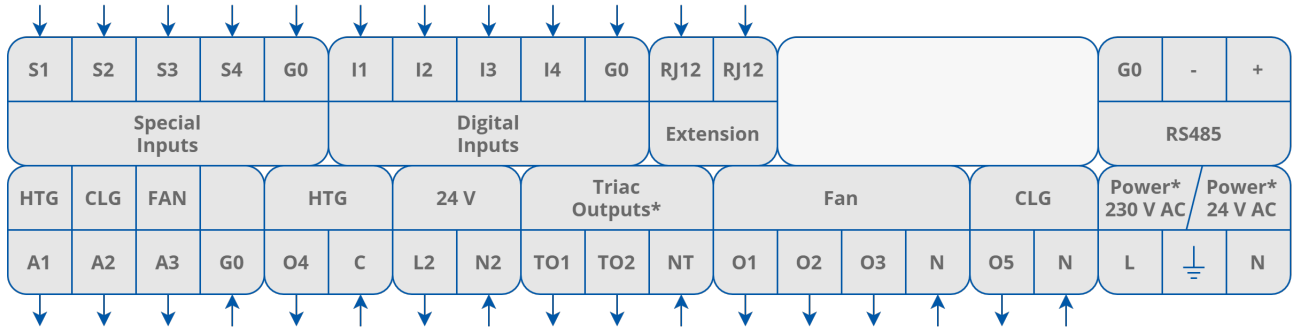

Figure 9. FCU connectors

3.8.1 Temperature Source: iSMA-B-LP/Touch Point/FP Room Panel

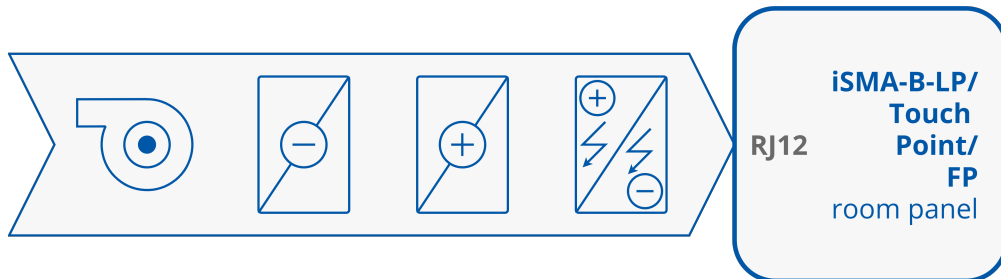
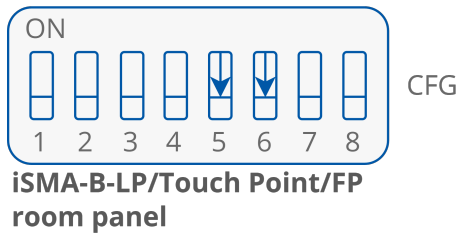
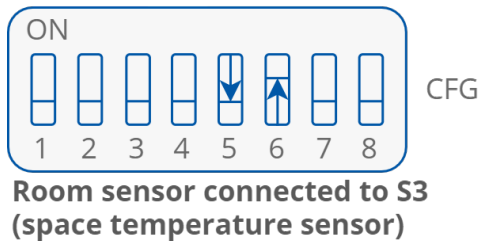

Figure 10. The LP/Touch Point room panel set as a temperature source

3.8.2 Temperature Source Connected to S3



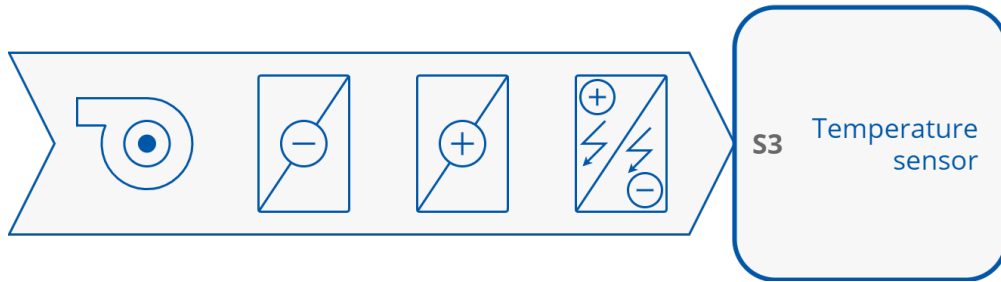

Figure 11. Temperature sensor connected to S3 as a temperature control value source

3.8.3 Temperature Source Connected to S1

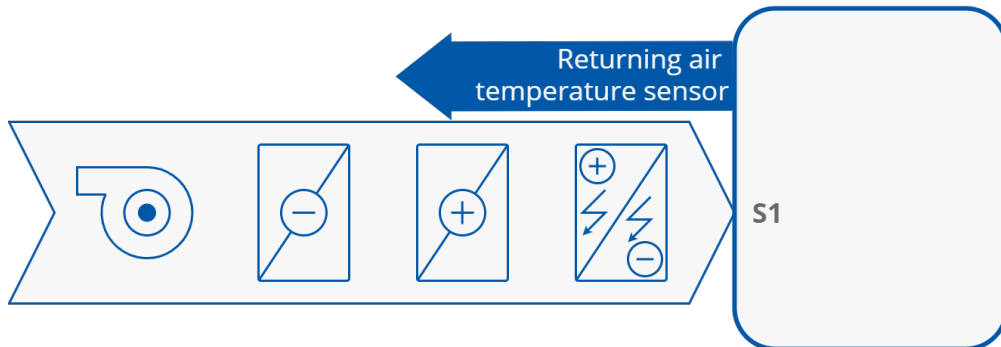
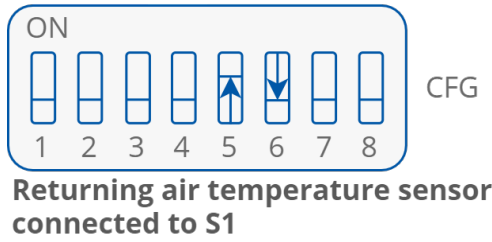

Figure 12. Returning air temperature sensor connected to S1

3.8.4 Temperature Source Connected to RS485 Network

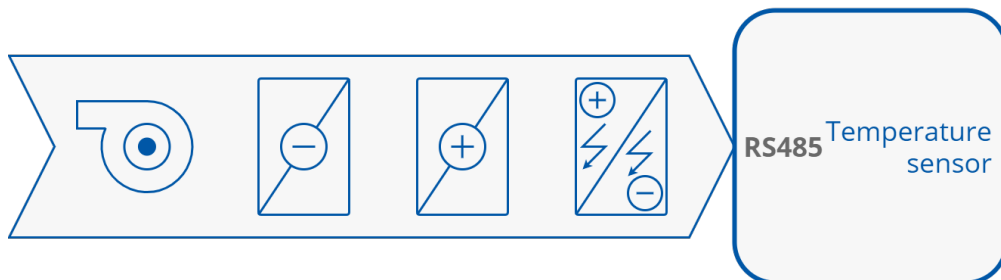
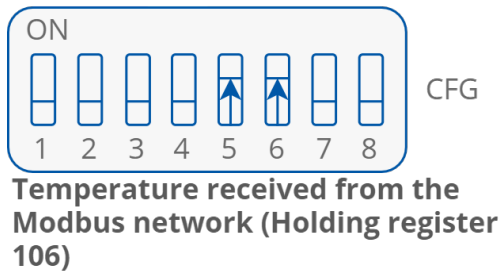

Figure 13. Temperature control value source set to the RS485 network

For more information, check the FCU Application manual and FCU Hardware manual.

3.9 Step 8: Selecting Type of Fan Used Within the Project and its Connection Details

There are many fan types the iSMA-B-FCU supports, and it can be configured for the fan coil unit used in the project.

3.9.1 Analog Controlled Fan Connection

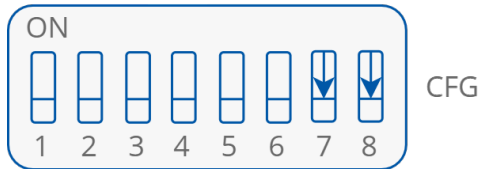

Analog controlled fan

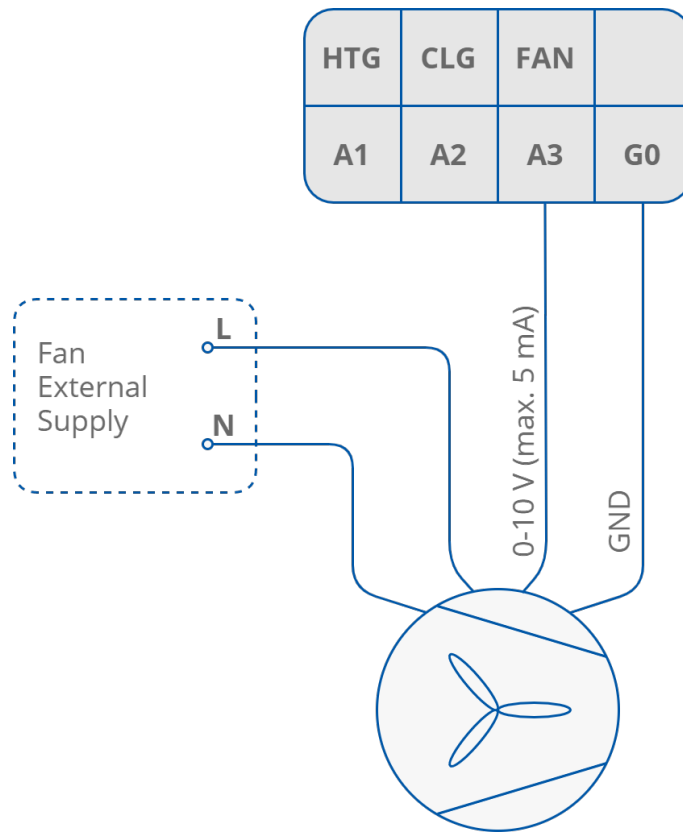

Figure 14. Analog controlled fan connection

3.9.2 1-speed Fan Connection



1 Speed Fan

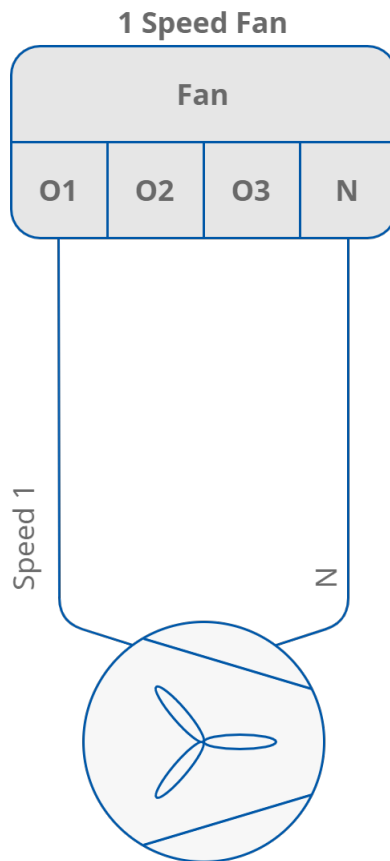
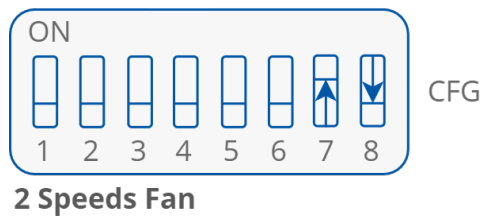

Figure 15. 1-speed fan connection

3.9.3 2-speed Fan Connection



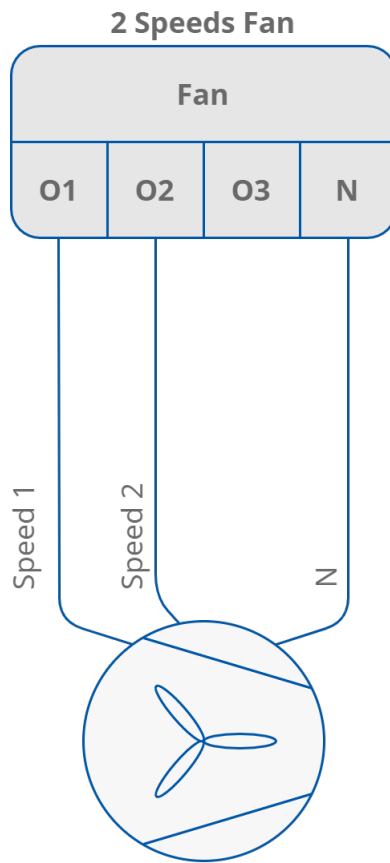
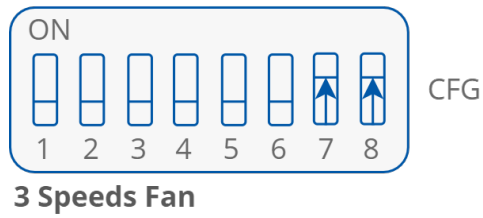

Figure 16. 2-speed fan connection

3.9.4 3-speed Fan Connection



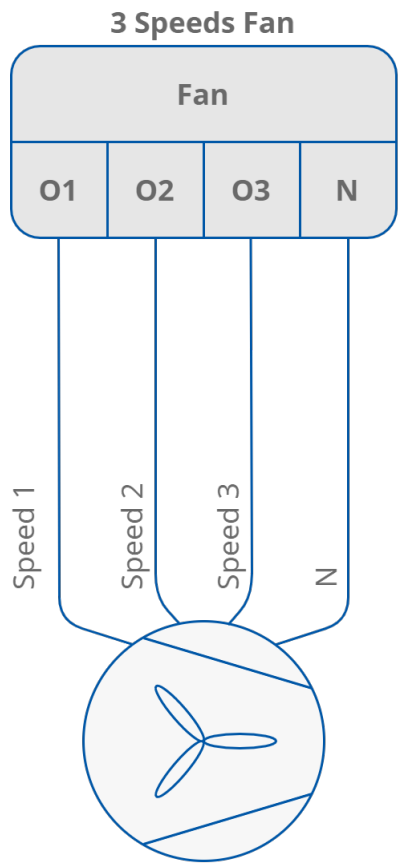

Figure 17. 3-speed fan connection

4 Examples: Connecting Actuators and Sensors to the Controller

4.1 Connections Overview

S1	S2	S3	S4	G0	I1	I2	I3	I4	G0	RJ12	RJ12					G0	-	+	
Special Inputs				Digital Inputs						Extension		RS485							
HTG	CLG	FAN		HTG		24 V		Triac Outputs*			Fan				CLG		Power* 230 V AC	Power* 24 V AC	
A1	A2	A3	G0	O4	C	L2	N2	TO1	TO2	NT	O1	O2	O3	N	O5	N	L	⏏	N

Figure 18. Inputs and outputs overview

4.2 Connection Examples

The examples below do not include selection of the temperature control value source. Connecting the temperature control value source is described in Step 7 of this manual. In examples, DIP switch sections 5 and 6 are set to OFF.

The 24 V power source for heater and cooler actuators can be taken from L2/N2 connectors.

If 2nd stages of heating or cooling is used, check Step 6 for connection information.

4.2.1 4-pipe Installation with 1-stage Digital Controlled Heating and Cooling and Analog Controlled Fan

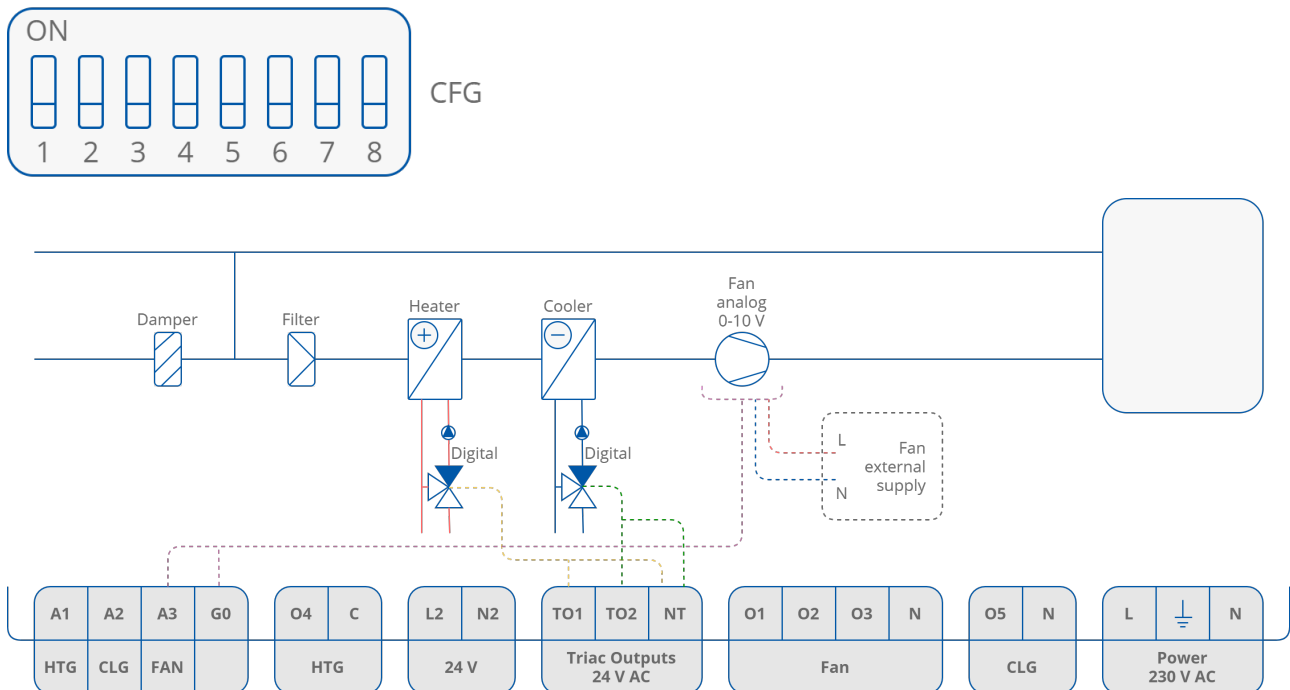

Figure 19. 4-pipe installation with 1 stage digital controlled heating and cooling and analog controlled fan

4.2.2 4-pipe Installation with 1-stage Digital Controlled Heating and Cooling and 1-speed Fan

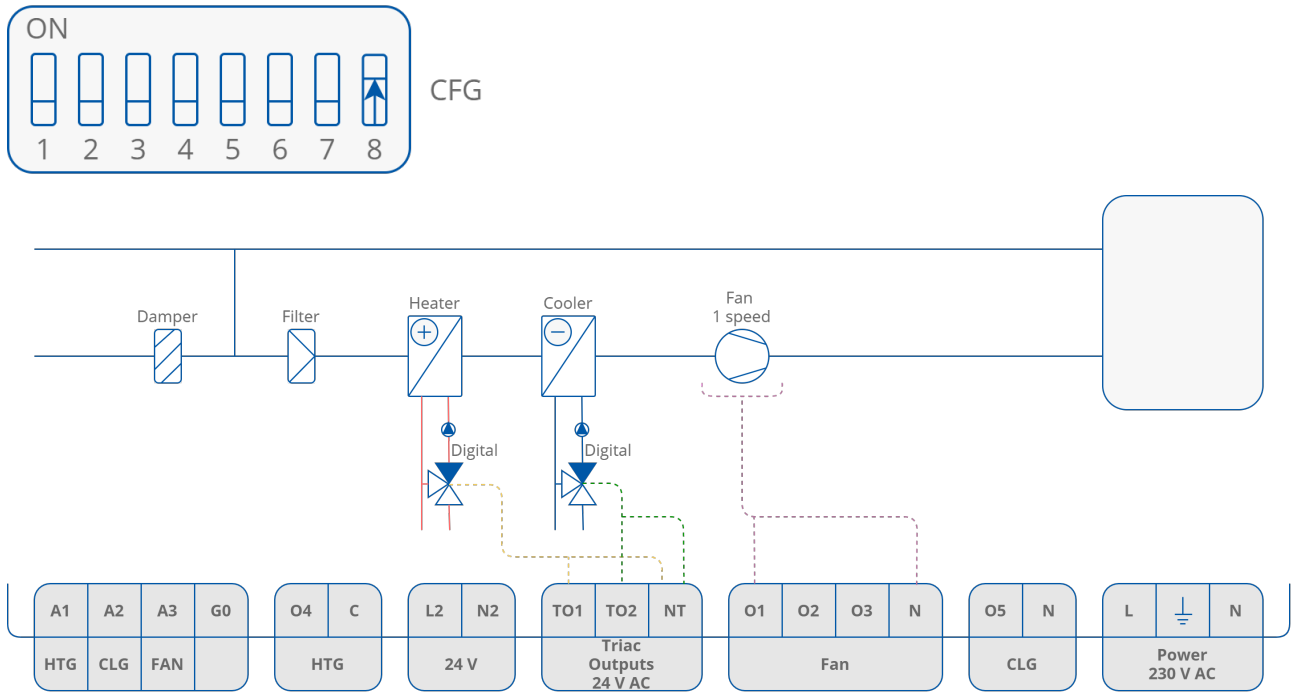

Figure 20. 4-pipe installation with 1-stage digital controlled heating and cooling and 1-speed fan

4.2.3 4-pipe Installation with 1-stage Digital Controlled Heating and Cooling and 2-speed Fan

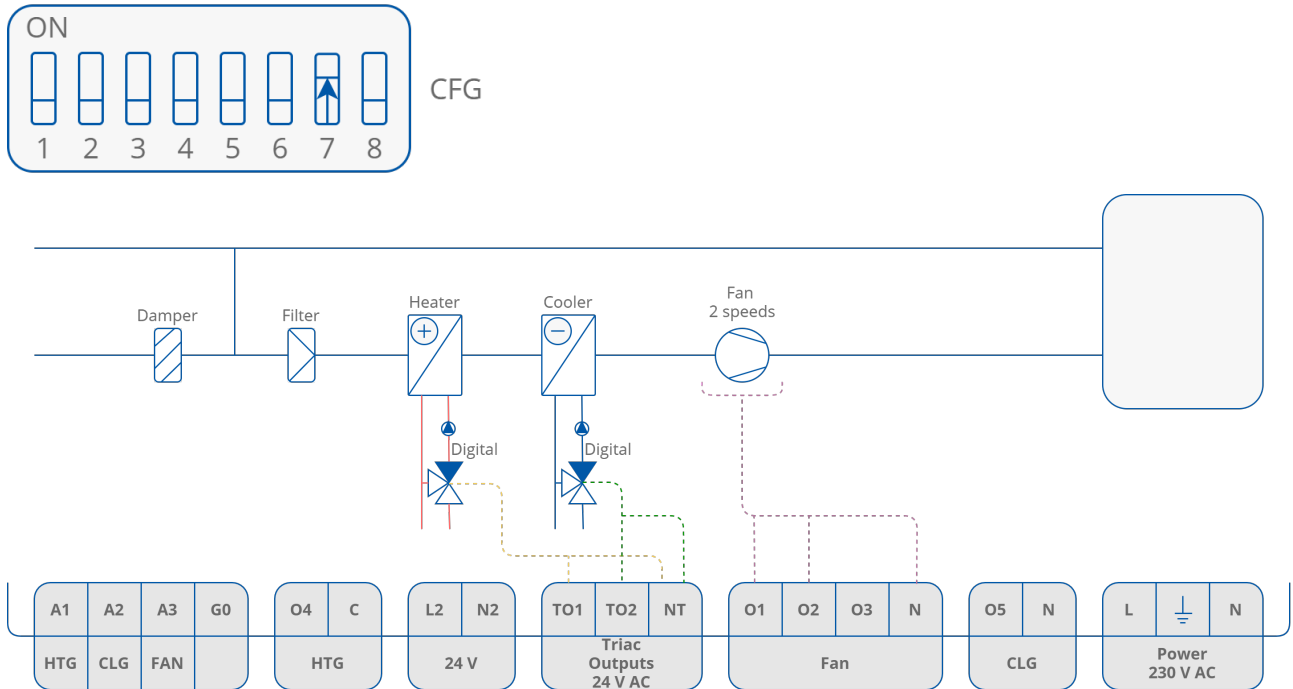

Figure 21. 4-pipe installation with 1-stage digital controlled heating and cooling and 2-speed fan

4.2.4 4-pipe Installation with 1-stage Digital Controlled Heating and Cooling and 3-speed Fan

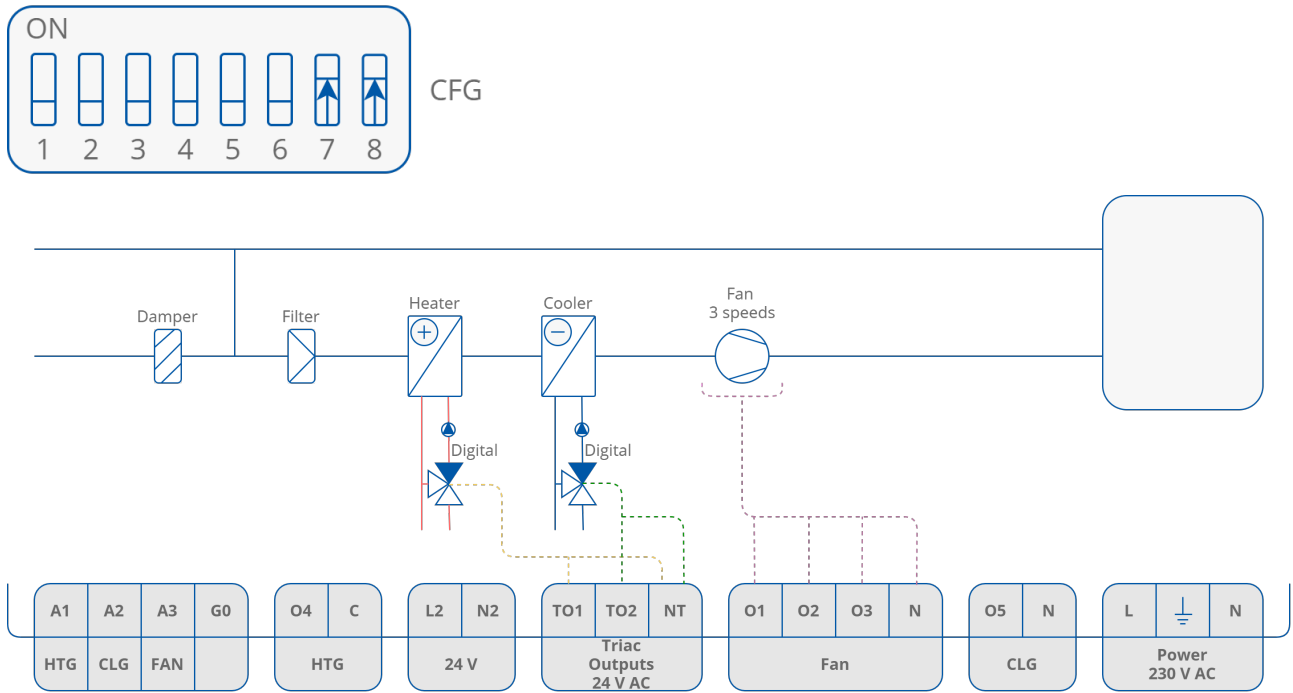

Figure 22. 4-pipe installation with 1-stage digital controlled heating and cooling and 3-speed fan

4.2.5 4-pipe Installation with 1-stage Analog Controlled Heating and Cooling and Analog Controlled Fan

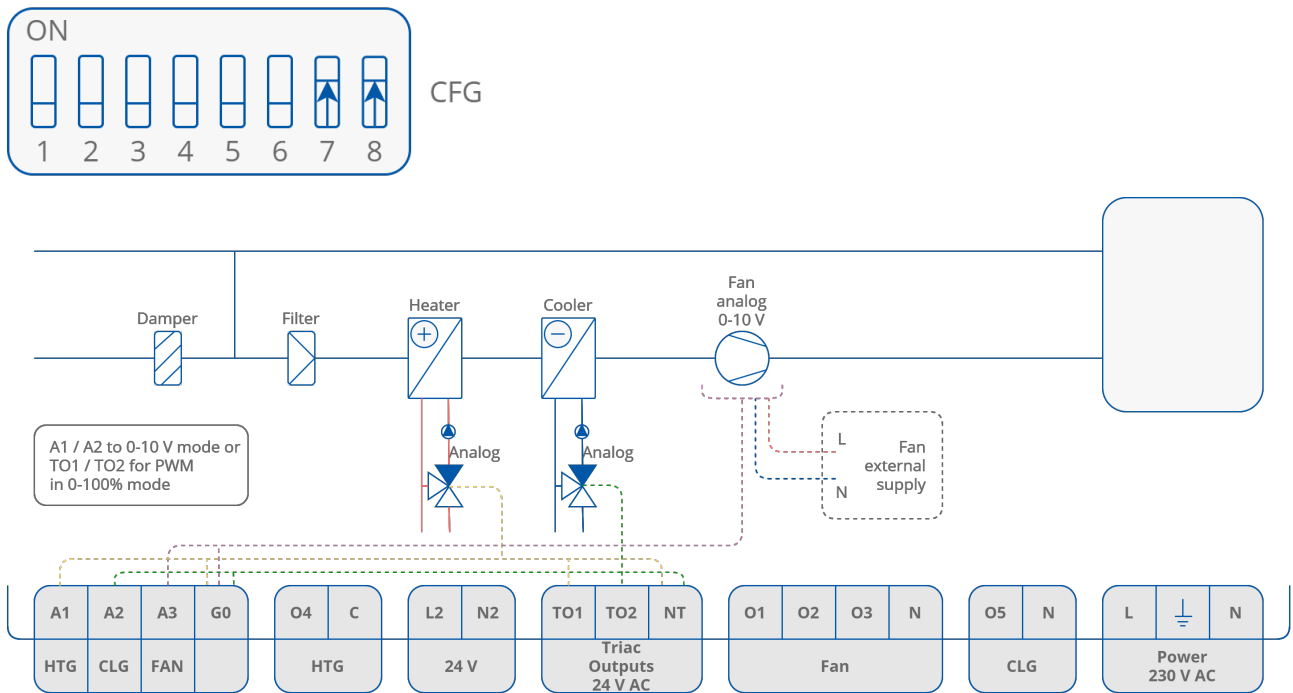

Figure 23. 4-pipe installation with 1 stage analog controlled heating and cooling and analog controlled fan

4.2.6 4-pipe Installation with 1-stage Analog Controlled Heating and Cooling and 1-speed Fan

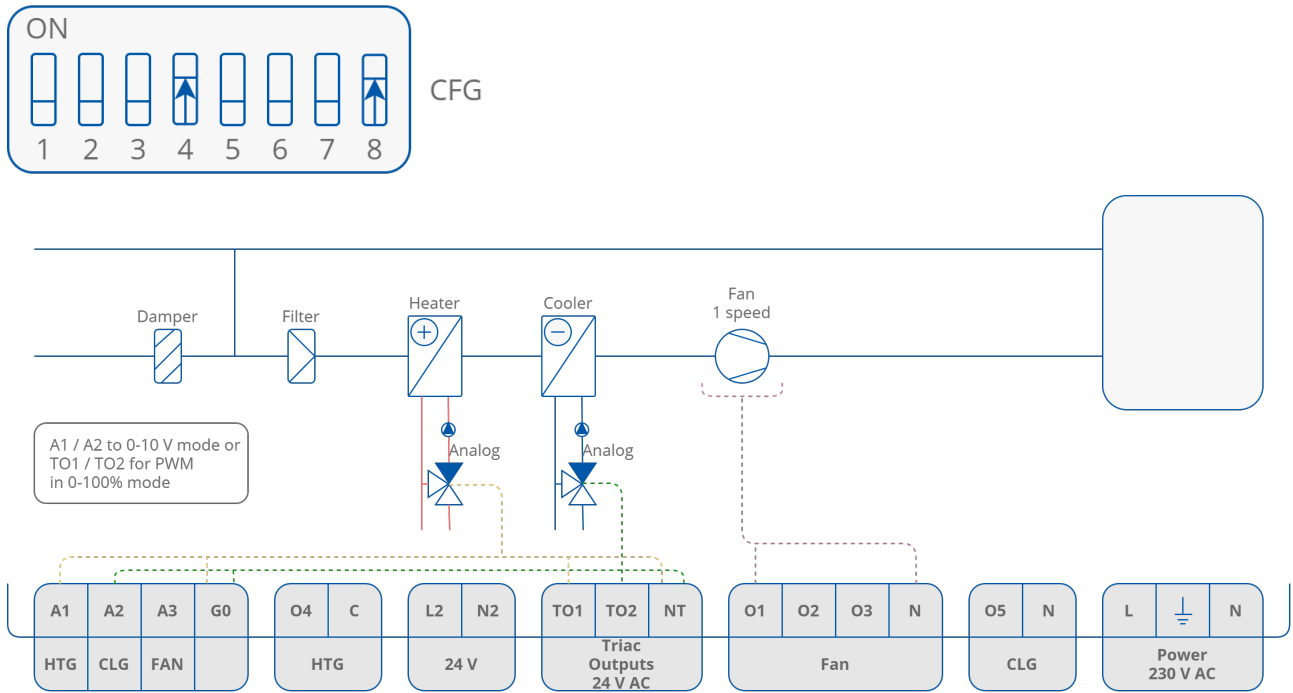

Figure 24. 4-pipe installation with 1-stage analog controlled heating and cooling and 1-speed fan

4.2.7 4-pipe Installation with 1-stage Analog Controlled Heating and Cooling and 2-speed Fan

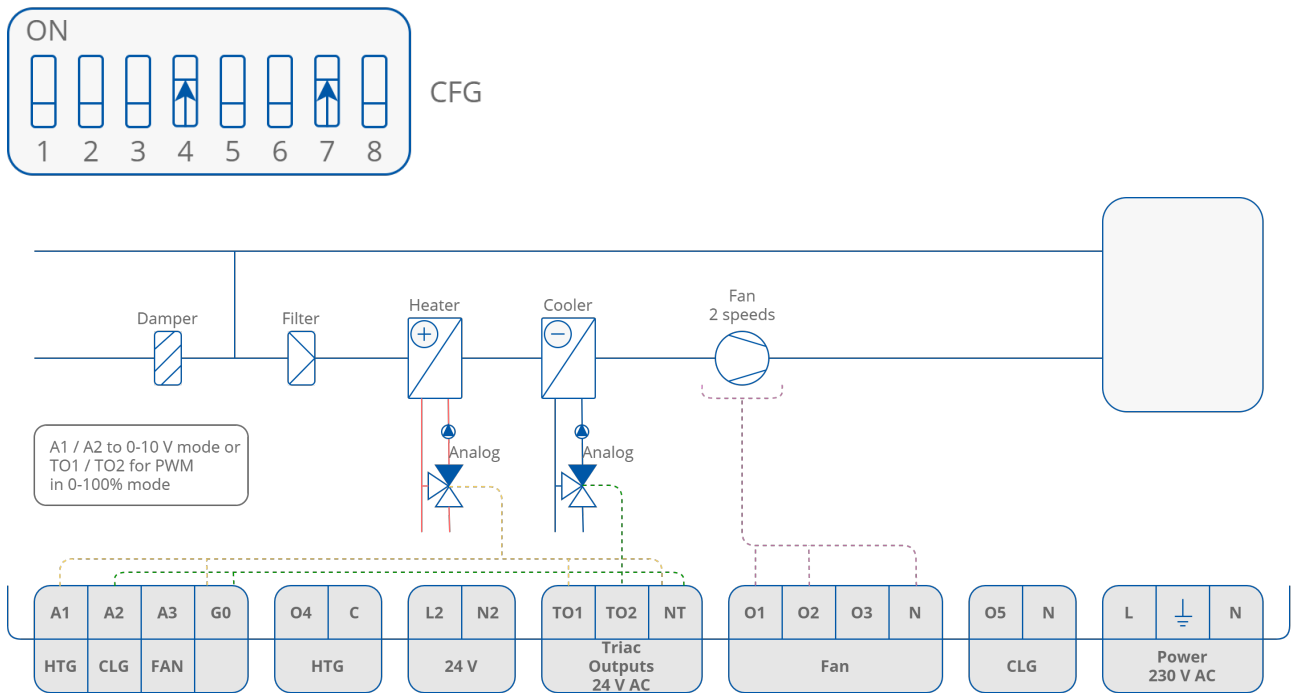

Figure 25. 4-pipe installation with 1-stage analog controlled heating and cooling and 2-speed fan

4.2.8 4-pipe Installation with 1-stage Analog Controlled Heating and Cooling and 3-speed Fan

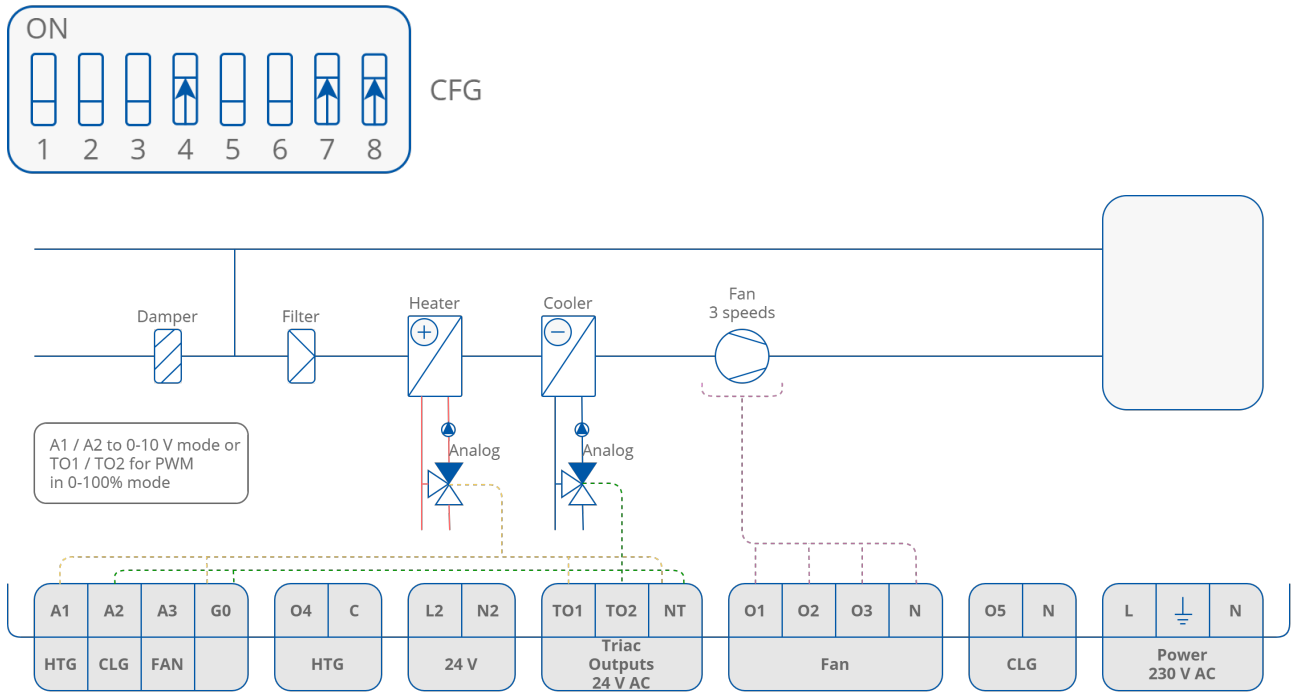

Figure 26. 4-pipe installation with 1-stage analog controlled heating and cooling and 3-speed fan

4.2.9 2-pipe Installation with 1-stage Digital Controlled Cooling and Analog Controlled Fan

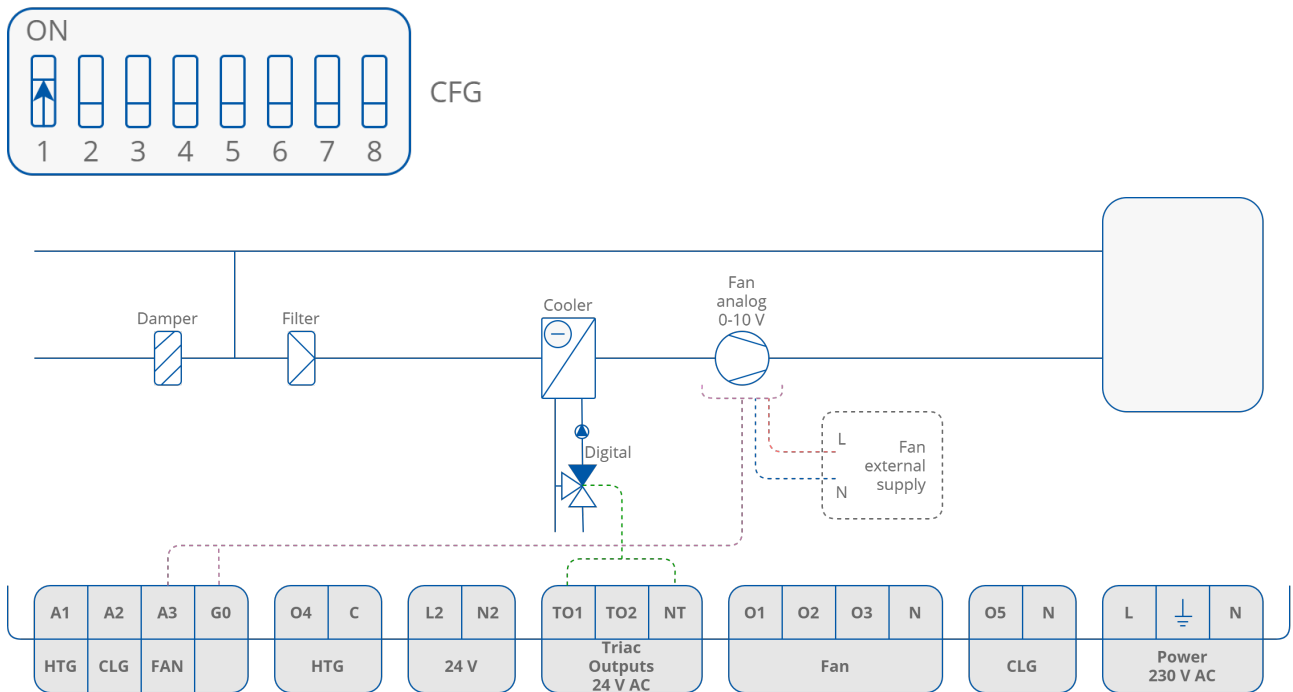

Figure 27. 2-pipe installation with 1-stage digital controlled cooling and analog controlled fan

4.2.10 2-pipe Installation with 1-stage Digital Controlled Heating and 1-speed Fan

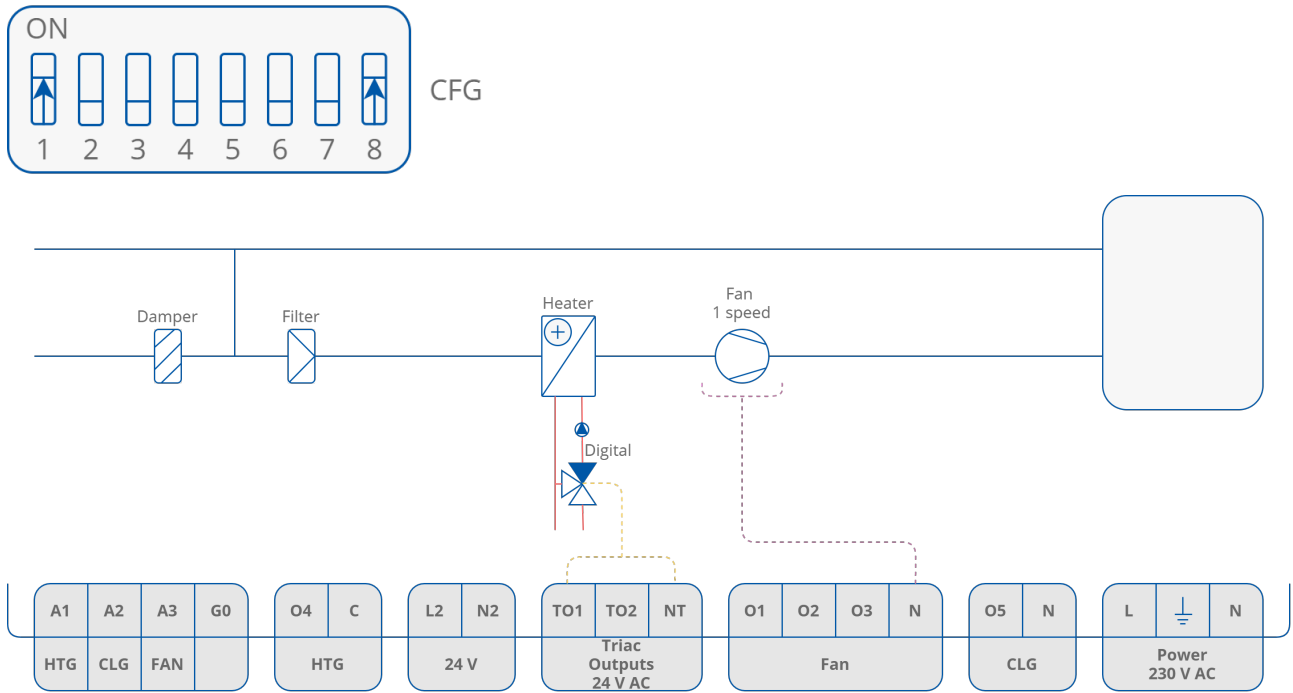

Figure 28. 2-pipe installation with 1-stage digital controlled heating and 1-speed fan

4.2.11 2-pipe Installation with 1-stage Digital Controlled Cooling and 2-speed Fan

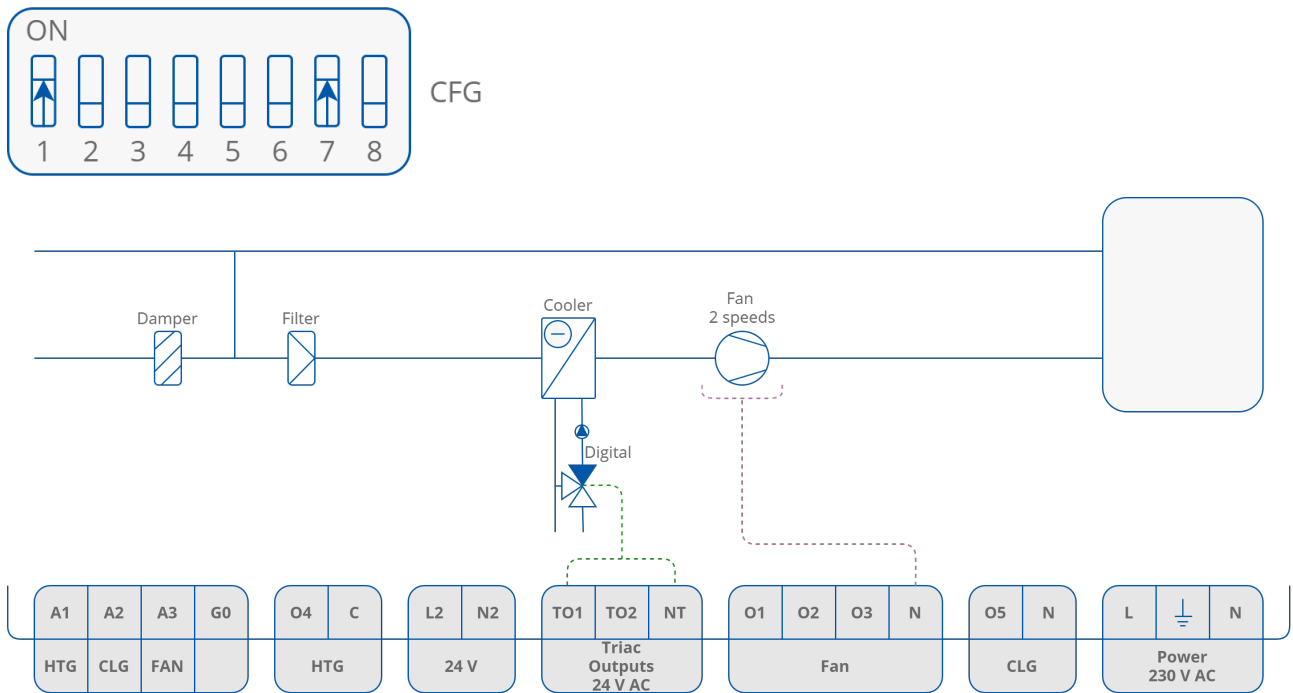

Figure 29. 2-pipe installation with 1-stage digital controlled cooling and 2-speed fan

4.2.12 2-pipe Installation with 1-stage Digital Controlled Heating and 3-speed Fan

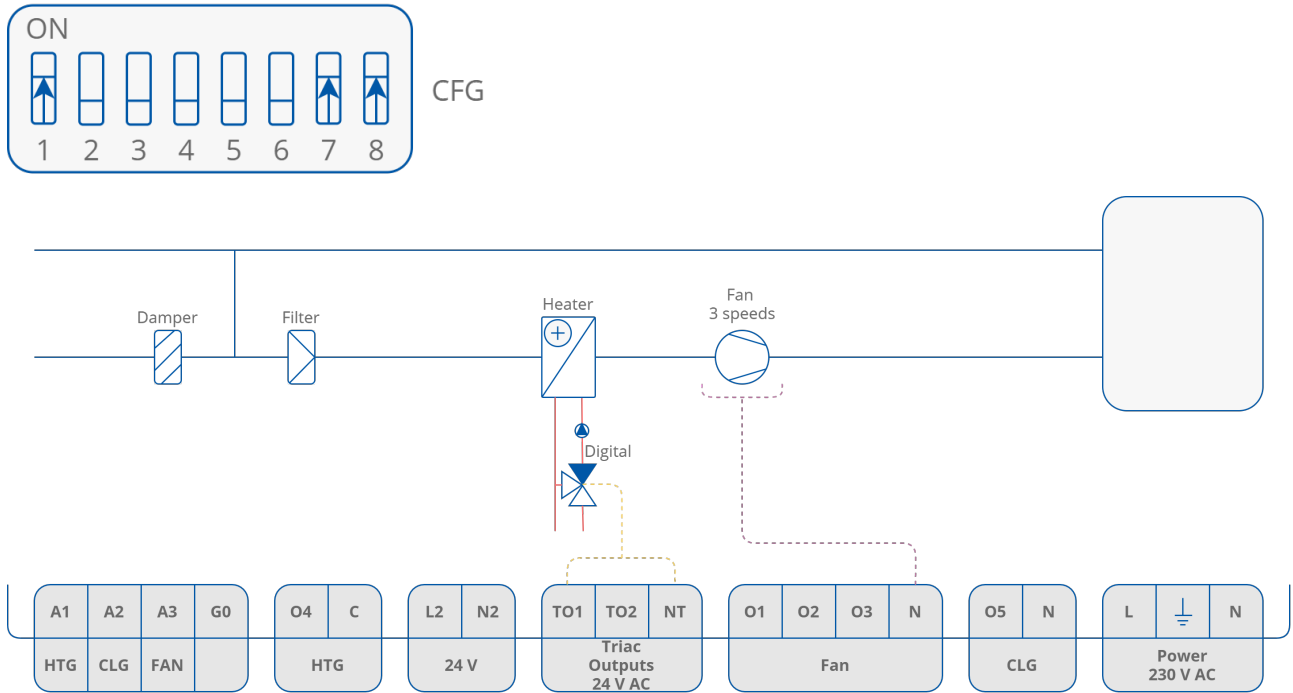

Figure 30. 2-pipe installation with 1-stage digital controlled heating and 3-speed fan

4.2.13 2-pipe Installation with 1 Stage Analog Controlled Cooling and Analog Controlled Fan

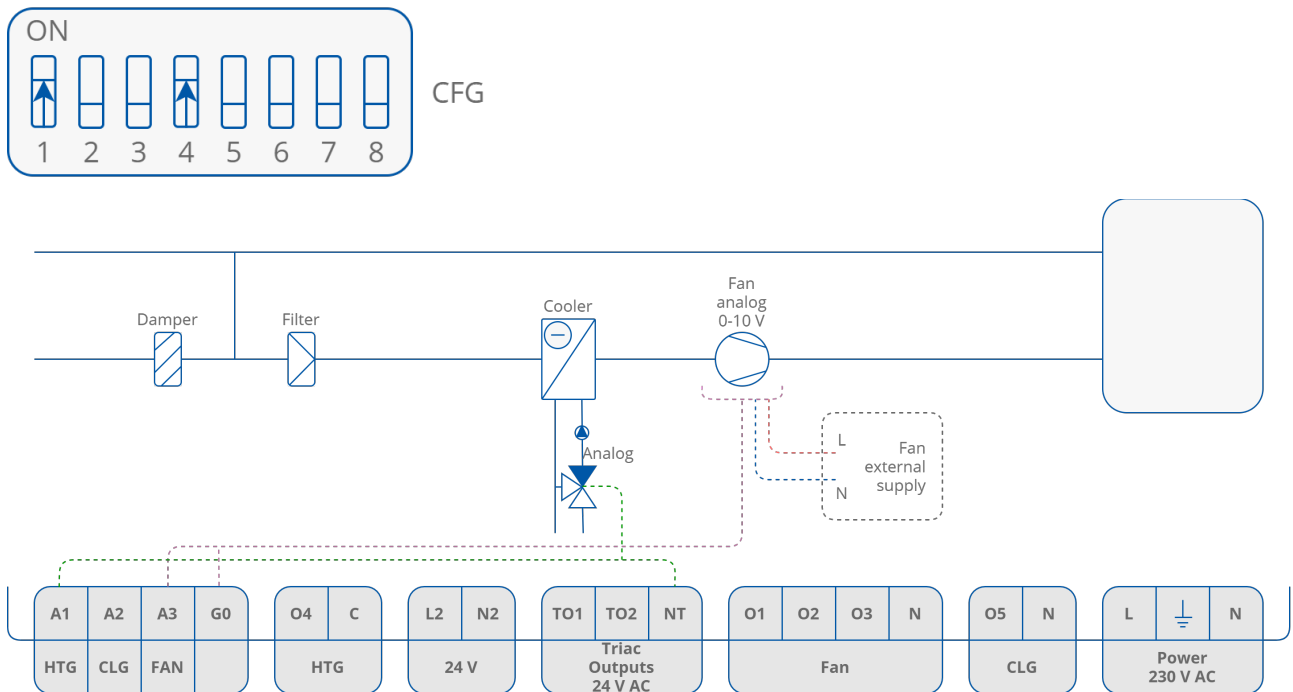

Figure 31. 2-pipe installation with 1-stage analog controlled cooling and analog controlled fan

4.2.14 2-pipe Installation with 1-stage Analog Controlled Heating and 1-speed Fan

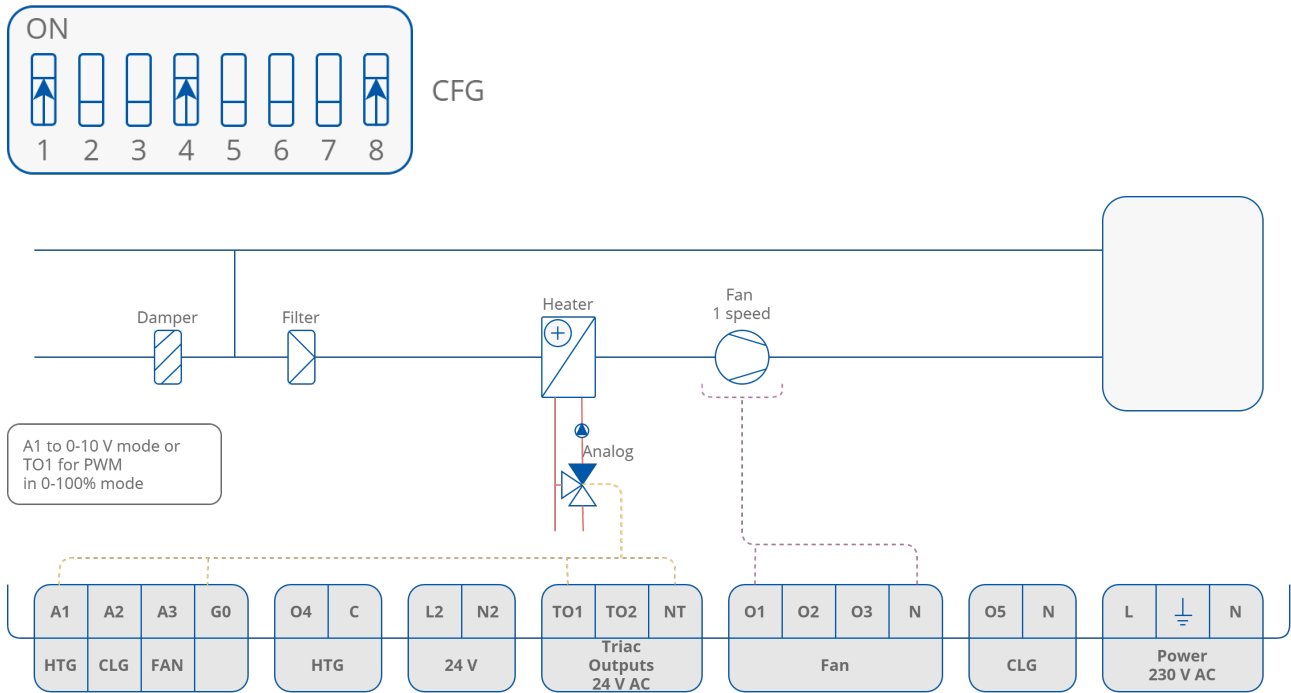

Figure 32. 2-pipe installation with 1-stage analog controlled heating and 1-speed fan

4.2.15 2-pipe Installation with 1-stage Analog Controlled Cooling and 2-speed Fan

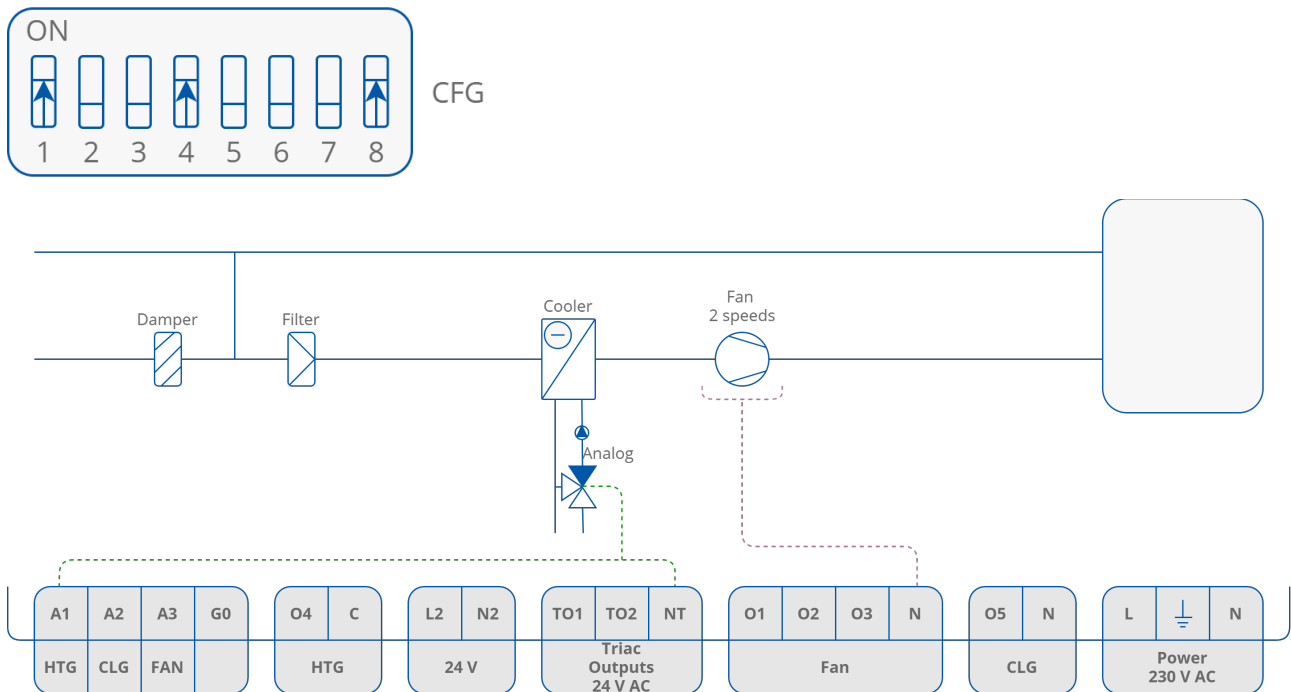

Figure 33. 2-pipe installation with 1-stage analog controlled cooling and 2-speed fan

4.2.16 2-pipe Installation with 1-stage Analog Controlled Heating and 3-speed Fan

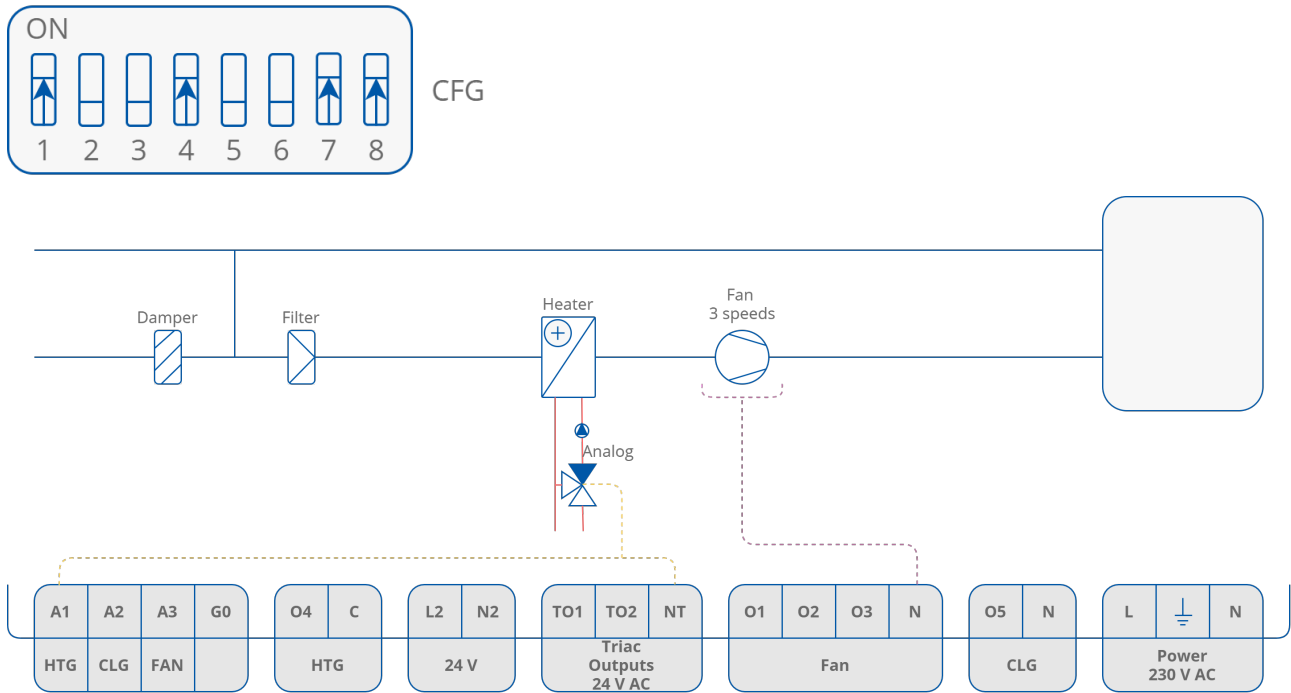









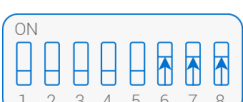
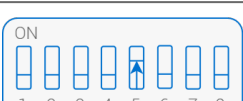
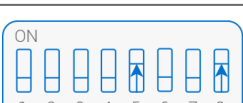

Figure 34. 2-pipe installation with 1-stage analog controlled heating and 3-speed fan









5 All Configurations for FCU Default Application





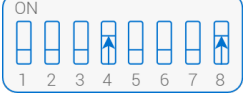

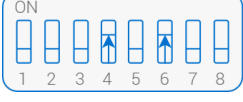



DIP Switch	5	6	7	8	Setting
Temperature source	OFF	OFF			iSMA-B-LP/Touch Point/FP room panel
	OFF	ON			Room sensor (SI3)
	ON	OFF			Returning air temperature sensor (SI1)
	ON	ON			Temperature from Modbus network
Fan			OFF	OFF	Analog control
			OFF	ON	1 speed
			ON	OFF	2 speeds
			ON	ON	3 speeds







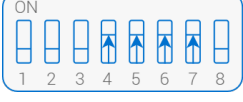
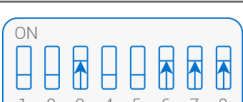

Table 7. DIP switch settings for selecting a temperature source and fan type









DIP Switch	1	2	3	4	5 & 6	7 & 8	
Function	FCU Pipe Mode	Heating	Cooling	Control	Temperature source	Fan	
	Off (4-pipe) On (2-pipe)	Off (1-stage) On (2-stage)	Off (1-stage) On (2-stage)	Off (digital) On (analog)	For configuration see table above	For configuration see table above	
1	4-pipe	1-stage heating	1-stage cooling	Digital control	iSMA-B-LP/Touch Point/FP room panel	Analog control	
2	4-pipe	1-stage heating	1-stage cooling	Digital control	iSMA-B-LP/Touch Point/FP room panel	1 speed	





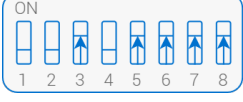

DIP Switch	1	2	3	4	5 & 6	7 & 8	
3	4-pipe	1-stage heating	1-stage cooling	Digital control	iSMA-B-LP/Touch Point/FP room panel	2 speeds	
4	4-pipe	1-stage heating	1-stage cooling	Digital control	iSMA-B-LP/Touch Point/FP room panel	3 speeds	
5	4-pipe	1-stage heating	1-stage cooling	Digital control	Room sensor (SI3)	Analog control	
6	4-pipe	1-stage heating	1-stage cooling	Digital control	Room sensor (SI3)	1 speed	
7	4-pipe	1-stage heating	1-stage cooling	Digital control	Room sensor (SI3)	2 speeds	
8	4-pipe	1-stage heating	1-stage cooling	Digital control	Room sensor (SI3)	3 speeds	
9	4-pipe	1-stage heating	1-stage cooling	Digital control	Returning air temperature sensor (SI1)	Analog control	
10	4-pipe	1-stage heating	1-stage cooling	Digital control	Returning air temperature sensor (SI1)	1 speed	
11	4-pipe	1-stage heating	1-stage cooling	Digital control	Returning air temperature sensor (SI1)	2 speeds	
12	4-pipe	1-stage heating	1-stage cooling	Digital control	Returning air temperature sensor (SI1)	3 speeds	







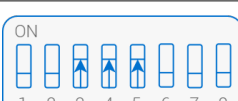
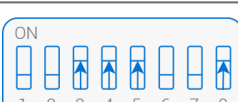
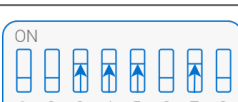

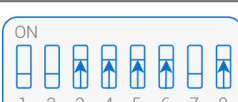
DIP Switch	1	2	3	4	5 & 6	7 & 8	
13	4-pipe	1-stage heating	1-stage cooling	Digital control	Temperature from Modbus network	Analog control	
14	4-pipe	1-stage heating	1-stage cooling	Digital control	Temperature from Modbus network	1 speed	
15	4-pipe	1-stage heating	1-stage cooling	Digital control	Temperature from Modbus network	2 speeds	
16	4-pipe	1-stage heating	1-stage cooling	Digital control	Temperature from Modbus network	3 speeds	
17	4-pipe	1-stage heating	1-stage cooling	Analog control	iSMA-B-LP/Touch Point/FP room panel	Analog control	
18	4-pipe	1-stage heating	1-stage cooling	Analog control	iSMA-B-LP/Touch Point/FP room panel	1 speed	
19	4-pipe	1-stage heating	1-stage cooling	Analog control	iSMA-B-LP/Touch Point/FP room panel	2 speeds	
20	4-pipe	1-stage heating	1-stage cooling	Analog control	iSMA-B-LP/Touch Point/FP room panel	3 speeds	
21	4-pipe	1-stage heating	1-stage cooling	Analog control	Room sensor (SI3)	Analog control	
22	4-pipe	1-stage heating	1-stage cooling	Analog control	Room sensor (SI3)	1 speed	



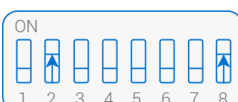







DIP Switch	1	2	3	4	5 & 6	7 & 8	
23	4-pipe	1-stage heating	1-stage cooling	Analog control	Room sensor (SI3)	2 speeds	 CFG
24	4-pipe	1-stage heating	1-stage cooling	Analog control	Room sensor (SI3)	3 speeds	 CFG
25	4-pipe	1-stage heating	1-stage cooling	Analog control	Returning air temperature sensor (SI1)	Analog control	 CFG
26	4-pipe	1-stage heating	1-stage cooling	Analog control	Returning air temperature sensor (SI1)	1 speed	 CFG
27	4-pipe	1-stage heating	1-stage cooling	Analog control	Returning air temperature sensor (SI1)	2 speeds	 CFG
28	4-pipe	1-stage heating	1-stage cooling	Analog control	Returning air temperature sensor (SI1)	3 speeds	 CFG
29	4-pipe	1-stage heating	1-stage cooling	Analog control	Temperature from Modbus network	Analog control	 CFG
30	4-pipe	1-stage heating	1-stage cooling	Analog control	Temperature from Modbus network	1 speed	 CFG
31	4-pipe	1-stage heating	1-stage cooling	Analog control	Temperature from Modbus network	2 speeds	 CFG
32	4-pipe	1-stage heating	1-stage cooling	Analog control	Temperature from Modbus network	3 speeds	 CFG





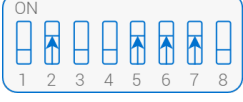

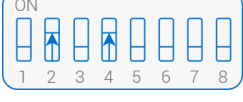

DIP Switch	1	2	3	4	5 & 6	7 & 8	
33	4-pipe	1-stage heating	2-stage cooling	Digital control	iSMA-B-LP/Touch Point/FP room panel	Analog control	 CFG
34	4-pipe	1-stage heating	2-stage cooling	Digital control	iSMA-B-LP/Touch Point/FP room panel	1 speed	 CFG
35	4-pipe	1-stage heating	2-stage cooling	Digital control	iSMA-B-LP/Touch Point/FP room panel	2 speeds	 CFG
36	4-pipe	1-stage heating	2-stage cooling	Digital control	iSMA-B-LP/Touch Point/FP room panel	3 speeds	 CFG
37	4-pipe	1-stage heating	2-stage cooling	Digital control	Room sensor (SI3)	Analog control	 CFG
38	4-pipe	1-stage heating	2-stage cooling	Digital control	Room sensor (SI3)	1 speed	 CFG
39	4-pipe	1-stage heating	2-stage cooling	Digital control	Room sensor (SI3)	2 speeds	 CFG
40	4-pipe	1-stage heating	2-stage cooling	Digital control	Room sensor (SI3)	3 speeds	 CFG
41	4-pipe	1-stage heating	2-stage cooling	Digital control	Returning air temperature sensor (SI1)	Analog control	 CFG
42	4-pipe	1-stage heating	2-stage cooling	Digital control	Returning air temperature sensor (SI1)	1 speed	 CFG





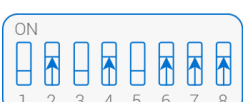

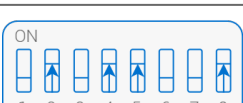



DIP Switch	1	2	3	4	5 & 6	7 & 8	
43	4-pipe	1-stage heating	2-stage cooling	Digital control	Returning air temperature sensor (S1)	2 speeds	 CFG
44	4-pipe	1-stage heating	2-stage cooling	Digital control	Returning air temperature sensor (S1)	3 speeds	 CFG
45	4-pipe	1-stage heating	2-stage cooling	Digital control	Temperature from Modbus network	Analog control	 CFG
46	4-pipe	1-stage heating	2-stage cooling	Digital control	Temperature from Modbus network	1 speed	 CFG
47	4-pipe	1-stage heating	2-stage cooling	Digital control	Temperature from Modbus network	2 speeds	 CFG
48	4-pipe	1-stage heating	2-stage cooling	Digital control	Temperature from Modbus network	3 speeds	 CFG
49	4-pipe	1-stage heating	2-stage cooling	Analog control	iSMA-B-LP/Touch Point/FP room panel	Analog control	 CFG
50	4-pipe	1-stage heating	2-stage cooling	Analog control	iSMA-B-LP/Touch Point/FP room panel	1 speed	 CFG
51	4-pipe	1-stage heating	2-stage cooling	Analog control	iSMA-B-LP/Touch Point/FP room panel	2 speeds	 CFG
52	4-pipe	1-stage heating	2-stage cooling	Analog control	iSMA-B-LP/Touch Point/FP room panel	3 speeds	 CFG









DIP Switch	1	2	3	4	5 & 6	7 & 8	
53	4-pipe	1-stage heating	2-stage cooling	Analog control	Room sensor (SI3)	Analog control	 CFG
54	4-pipe	1-stage heating	2-stage cooling	Analog control	Room sensor (SI3)	1 speed	 CFG
55	4-pipe	1-stage heating	2-stage cooling	Analog control	Room sensor (SI3)	2 speeds	 CFG
56	4-pipe	1-stage heating	2-stage cooling	Analog control	Room sensor (SI3)	3 speeds	 CFG
57	4-pipe	1-stage heating	2-stage cooling	Analog control	Returning air temperature sensor (SI1)	Analog control	 CFG
58	4-pipe	1-stage heating	2-stage cooling	Analog control	Returning air temperature sensor (SI1)	1 speed	 CFG
59	4-pipe	1-stage heating	2-stage cooling	Analog control	Returning air temperature sensor (SI1)	2 speeds	 CFG
60	4-pipe	1-stage heating	2-stage cooling	Analog control	Returning air temperature sensor (SI1)	3 speeds	 CFG
61	4-pipe	1-stage heating	2-stage cooling	Analog control	Temperature from Modbus network	Analog control	 CFG
62	4-pipe	1-stage heating	2-stage cooling	Analog control	Temperature from Modbus network	1 speed	 CFG





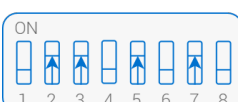
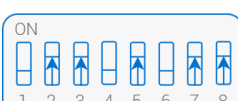
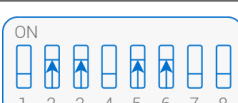

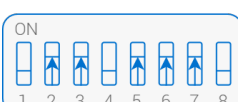

DIP Switch	1	2	3	4	5 & 6	7 & 8	
63	4-pipe	1-stage heating	2-stage cooling	Analog control	Temperature from Modbus network	2 speeds	 CFG
64	4-pipe	1-stage heating	2-stage cooling	Analog control	Temperature from Modbus network	3 speeds	 CFG
65	4-pipe	2-stage heating	1-stage cooling	Digital control	iSMA-B-LP/Touch Point/FP room panel	Analog control	 CFG
66	4-pipe	2-stage heating	1-stage cooling	Digital control	iSMA-B-LP/Touch Point/FP room panel	1 speed	 CFG
67	4-pipe	2-stage heating	1-stage cooling	Digital control	iSMA-B-LP/Touch Point/FP room panel	2 speeds	 CFG
68	4-pipe	2-stage heating	1-stage cooling	Digital control	iSMA-B-LP/Touch Point/FP room panel	3 speeds	 CFG
69	4-pipe	2-stage heating	1-stage cooling	Digital control	Room sensor (SI3)	Analog control	 CFG
70	4-pipe	2-stage heating	1-stage cooling	Digital control	Room sensor (SI3)	1 speed	 CFG
71	4-pipe	2-stage heating	1-stage cooling	Digital control	Room sensor (SI3)	2 speeds	 CFG
72	4-pipe	2-stage heating	1-stage cooling	Digital control	Room sensor (SI3)	3 speeds	 CFG









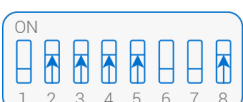

DIP Switch	1	2	3	4	5 & 6	7 & 8	
73	4-pipe	2-stage heating	1-stage cooling	Digital control	Returning air temperature sensor (S1)	Analog control	 CFG
74	4-pipe	2-stage heating	1-stage cooling	Digital control	Returning air temperature sensor (S1)	1 speed	 CFG
75	4-pipe	2-stage heating	1-stage cooling	Digital control	Returning air temperature sensor (S1)	2 speeds	 CFG
76	4-pipe	2-stage heating	1-stage cooling	Digital control	Returning air temperature sensor (S1)	3 speeds	 CFG
77	4-pipe	2-stage heating	1-stage cooling	Digital control	Temperature from Modbus network	Analog control	 CFG
78	4-pipe	2-stage heating	1-stage cooling	Digital control	Temperature from Modbus network	1 speed	 CFG
79	4-pipe	2-stage heating	1-stage cooling	Digital control	Temperature from Modbus network	2 speeds	 CFG
80	4-pipe	2-stage heating	1-stage cooling	Digital control	Temperature from Modbus network	3 speeds	 CFG
81	4-pipe	2-stage heating	1-stage cooling	Analog control	iSMA-B-LP/Touch Point/FP room panel	Analog control	 CFG
82	4-pipe	2-stage heating	1-stage cooling	Analog control	iSMA-B-LP/Touch Point/FP room panel	1 speed	 CFG











DIP Switch	1	2	3	4	5 & 6	7 & 8	
83	4-pipe	2-stage heating	1-stage cooling	Analog control	iSMA-B-LP/Touch Point/FP room panel	2 speeds	 CFG
84	4-pipe	2-stage heating	1-stage cooling	Analog control	iSMA-B-LP/Touch Point/FP room panel	3 speeds	 CFG
85	4-pipe	2-stage heating	1-stage cooling	Analog control	Room sensor (SI3)	Analog control	 CFG
86	4-pipe	2-stage heating	1-stage cooling	Analog control	Room sensor (SI3)	1 speed	 CFG
87	4-pipe	2-stage heating	1-stage cooling	Analog control	Room sensor (SI3)	2 speeds	 CFG
88	4-pipe	2-stage heating	1-stage cooling	Analog control	Room sensor (SI3)	3 speeds	 CFG
89	4-pipe	2-stage heating	1-stage cooling	Analog control	Returning air temperature sensor (SI1)	Analog control	 CFG
90	4-pipe	2-stage heating	1-stage cooling	Analog control	Returning air temperature sensor (SI1)	1 speed	 CFG
91	4-pipe	2-stage heating	1-stage cooling	Analog control	Returning air temperature sensor (SI1)	2 speeds	 CFG
92	4-pipe	2-stage heating	1-stage cooling	Analog control	Returning air temperature sensor (SI1)	3 speeds	 CFG











DIP Switch	1	2	3	4	5 & 6	7 & 8	
93	4-pipe	2-stage heating	1-stage cooling	Analog control	Temperature from Modbus network	Analog control	 CFG
94	4-pipe	2-stage heating	1-stage cooling	Analog control	Temperature from Modbus network	1 speed	 CFG
95	4-pipe	2-stage heating	1-stage cooling	Analog control	Temperature from Modbus network	2 speeds	 CFG
96	4-pipe	2-stage heating	1-stage cooling	Analog control	Temperature from Modbus network	3 speeds	 CFG
97	4-pipe	2-stage heating	2-stage cooling	Digital control	iSMA-B-LP/Touch Point/FP room panel	Analog control	 CFG
98	4-pipe	2-stage heating	2-stage cooling	Digital control	iSMA-B-LP/Touch Point/FP room panel	1 speed	 CFG
99	4-pipe	2-stage heating	2-stage cooling	Digital control	iSMA-B-LP/Touch Point/FP room panel	2 speeds	 CFG
100	4-pipe	2-stage heating	2-stage cooling	Digital control	iSMA-B-LP/Touch Point/FP room panel	3 speeds	 CFG
101	4-pipe	2-stage heating	2-stage cooling	Digital control	Room sensor (SI3)	Analog control	 CFG
102	4-pipe	2-stage heating	2-stage cooling	Digital control	Room sensor (SI3)	1 speed	 CFG



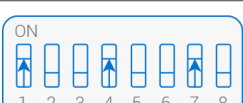







DIP Switch	1	2	3	4	5 & 6	7 & 8	
103	4-pipe	2-stage heating	2-stage cooling	Digital control	Room sensor (SI3)	2 speeds	
104	4-pipe	2-stage heating	2-stage cooling	Digital control	Room sensor (SI3)	3 speeds	
105	4-pipe	2-stage heating	2-stage cooling	Digital control	Returning air temperature sensor (SI1)	Analog control	
106	4-pipe	2-stage heating	2-stage cooling	Digital control	Returning air temperature sensor (SI1)	1 speed	
107	4-pipe	2-stage heating	2-stage cooling	Digital control	Returning air temperature sensor (SI1)	2 speeds	
108	4-pipe	2-stage heating	2-stage cooling	Digital control	Returning air temperature sensor (SI1)	3 speeds	
109	4-pipe	2-stage heating	2-stage cooling	Digital control	Temperature from Modbus network	Analog control	
110	4-pipe	2-stage heating	2-stage cooling	Digital control	Temperature from Modbus network	1 speed	
111	4-pipe	2-stage heating	2-stage cooling	Digital control	Temperature from Modbus network	2 speeds	
112	4-pipe	2-stage heating	2-stage cooling	Digital control	Temperature from Modbus network	3 speeds	







DIP Switch	1	2	3	4	5 & 6	7 & 8	
113	4-pipe	2-stage heating	2-stage cooling	Analog control	iSMA-B-LP/Touch Point/FP room panel	Analog control	
114	4-pipe	2-stage heating	2-stage cooling	Analog control	iSMA-B-LP/Touch Point/FP room panel	1 speed	
115	4-pipe	2-stage heating	2-stage cooling	Analog control	iSMA-B-LP/Touch Point/FP room panel	2 speeds	
116	4-pipe	2-stage heating	2-stage cooling	Analog control	iSMA-B-LP/Touch Point/FP room panel	3 speeds	
117	4-pipe	2-stage heating	2-stage cooling	Analog control	Room sensor (SI3)	Analog control	
118	4-pipe	2-stage heating	2-stage cooling	Analog control	Room sensor (SI3)	1 speed	
119	4-pipe	2-stage heating	2-stage cooling	Analog control	Room sensor (SI3)	2 speeds	
120	4-pipe	2-stage heating	2-stage cooling	Analog control	Room sensor (SI3)	3 speeds	
121	4-pipe	2-stage heating	2-stage cooling	Analog control	Returning air temperature sensor (SI1)	Analog control	
122	4-pipe	2-stage heating	2-stage cooling	Analog control	Returning air temperature sensor (SI1)	1 speed	







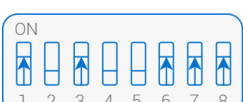
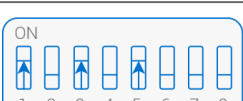
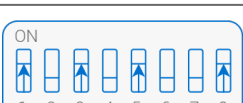



DIP Switch	1	2	3	4	5 & 6	7 & 8	
123	4-pipe	2-stage heating	2-stage cooling	Analog control	Returning air temperature sensor (S1)	2 speeds	 CFG
124	4-pipe	2-stage heating	2-stage cooling	Analog control	Returning air temperature sensor (S1)	3 speeds	 CFG
125	4-pipe	2-stage heating	2-stage cooling	Analog control	Temperature from Modbus network	Analog control	 CFG
126	4-pipe	2-stage heating	2-stage cooling	Analog control	Temperature from Modbus network	1 speed	 CFG
127	4-pipe	2-stage heating	2-stage cooling	Analog control	Temperature from Modbus network	2 speeds	 CFG
128	4-pipe	2-stage heating	2-stage cooling	Analog control	Temperature from Modbus network	3 speeds	 CFG
129	2-pipe	1-stage heating	1-stage cooling	Digital control	iSMA-B-LP/Touch Point/FP room panel	Analog control	 CFG
130	2-pipe	1-stage heating	1-stage cooling	Digital control	iSMA-B-LP/Touch Point/FP room panel	1 speed	 CFG
131	2-pipe	1-stage heating	1-stage cooling	Digital control	iSMA-B-LP/Touch Point/FP room panel	2 speeds	 CFG
132	2-pipe	1-stage heating	1-stage cooling	Digital control	iSMA-B-LP/Touch Point/FP room panel	3 speeds	 CFG











DIP Switch	1	2	3	4	5 & 6	7 & 8	
133	2-pipe	1-stage heating	1-stage cooling	Digital control	Room sensor (SI3)	Analog control	 CFG
134	2-pipe	1-stage heating	1-stage cooling	Digital control	Room sensor (SI3)	1 speed	 CFG
135	2-pipe	1-stage heating	1-stage cooling	Digital control	Room sensor (SI3)	2 speeds	 CFG
136	2-pipe	1-stage heating	1-stage cooling	Digital control	Room sensor (SI3)	3 speeds	 CFG
137	2-pipe	1-stage heating	1-stage cooling	Digital control	Returning air temperature sensor (SI1)	Analog control	 CFG
138	2-pipe	1-stage heating	1-stage cooling	Digital control	Returning air temperature sensor (SI1)	1 speed	 CFG
139	2-pipe	1-stage heating	1-stage cooling	Digital control	Returning air temperature sensor (SI1)	2 speeds	 CFG
140	2-pipe	1-stage heating	1-stage cooling	Digital control	Returning air temperature sensor (SI1)	3 speeds	 CFG
141	2-pipe	1-stage heating	1-stage cooling	Digital control	Temperature from Modbus network	Analog control	 CFG
142	2-pipe	1-stage heating	1-stage cooling	Digital control	Temperature from Modbus network	1 speed	 CFG









DIP Switch	1	2	3	4	5 & 6	7 & 8	
143	2-pipe	1-stage heating	1-stage cooling	Digital control	Temperature from Modbus network	2 speeds	 CFG
144	2-pipe	1-stage heating	1-stage cooling	Digital control	Temperature from Modbus network	3 speeds	 CFG
145	2-pipe	1-stage heating	1-stage cooling	Analog control	iSMA-B-LP/Touch Point/FP room panel	Analog control	 CFG
146	2-pipe	1-stage heating	1-stage cooling	Analog control	iSMA-B-LP/Touch Point/FP room panel	1 speed	 CFG
147	2-pipe	1-stage heating	1-stage cooling	Analog control	iSMA-B-LP/Touch Point/FP room panel	2 speeds	 CFG
148	2-pipe	1-stage heating	1-stage cooling	Analog control	iSMA-B-LP/Touch Point/FP room panel	3 speeds	 CFG
149	2-pipe	1-stage heating	1-stage cooling	Analog control	Room sensor (SI3)	Analog control	 CFG
150	2-pipe	1-stage heating	1-stage cooling	Analog control	Room sensor (SI3)	1 speed	 CFG
151	2-pipe	1-stage heating	1-stage cooling	Analog control	Room sensor (SI3)	2 speeds	 CFG
152	2-pipe	1-stage heating	1-stage cooling	Analog control	Room sensor (SI3)	3 speeds	 CFG









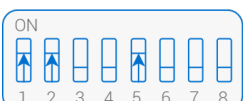
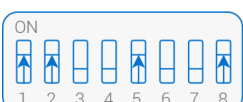

DIP Switch	1	2	3	4	5 & 6	7 & 8	
153	2-pipe	1-stage heating	1-stage cooling	Analog control	Returning air temperature sensor (S1)	Analog control	 CFG
154	2-pipe	1-stage heating	1-stage cooling	Analog control	Returning air temperature sensor (S1)	1 speed	 CFG
155	2-pipe	1-stage heating	1-stage cooling	Analog control	Returning air temperature sensor (S1)	2 speeds	 CFG
156	2-pipe	1-stage heating	1-stage cooling	Analog control	Returning air temperature sensor (S1)	3 speeds	 CFG
157	2-pipe	1-stage heating	1-stage cooling	Analog control	Temperature from Modbus network	Analog control	 CFG
158	2-pipe	1-stage heating	1-stage cooling	Analog control	Temperature from Modbus network	1 speed	 CFG
159	2-pipe	1-stage heating	1-stage cooling	Analog control	Temperature from Modbus network	2 speeds	 CFG
160	2-pipe	1-stage heating	1-stage cooling	Analog control	Temperature from Modbus network	3 speeds	 CFG
161	2-pipe	1-stage heating	2-stage cooling	Digital control	iSMA-B-LP/Touch Point/FP room panel	Analog control	 CFG
162	2-pipe	1-stage heating	2-stage cooling	Digital control	iSMA-B-LP/Touch Point/FP room panel	1 speed	 CFG





DIP Switch	1	2	3	4	5 & 6	7 & 8	
163	2-pipe	1-stage heating	2-stage cooling	Digital control	iSMA-B-LP/Touch Point/FP room panel	2 speeds	 CFG
164	2-pipe	1-stage heating	2-stage cooling	Digital control	iSMA-B-LP/Touch Point/FP room panel	3 speeds	 CFG
165	2-pipe	1-stage heating	2-stage cooling	Digital control	Room sensor (SI3)	Analog control	 CFG
166	2-pipe	1-stage heating	2-stage cooling	Digital control	Room sensor (SI3)	1 speed	 CFG
167	2-pipe	1-stage heating	2-stage cooling	Digital control	Room sensor (SI3)	2 speeds	 CFG
168	2-pipe	1-stage heating	2-stage cooling	Digital control	Room sensor (SI3)	3 speeds	 CFG
169	2-pipe	1-stage heating	2-stage cooling	Digital control	Returning air temperature sensor (SI1)	Analog control	 CFG
170	2-pipe	1-stage heating	2-stage cooling	Digital control	Returning air temperature sensor (SI1)	1 speed	 CFG
171	2-pipe	1-stage heating	2-stage cooling	Digital control	Returning air temperature sensor (SI1)	2 speeds	 CFG
172	2-pipe	1-stage heating	2-stage cooling	Digital control	Returning air temperature sensor (SI1)	3 speeds	 CFG







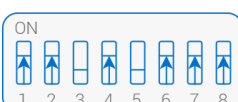
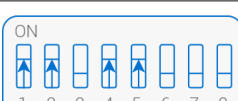
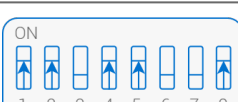
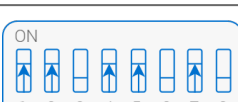

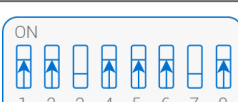

DIP Switch	1	2	3	4	5 & 6	7 & 8	
173	2-pipe	1-stage heating	2-stage cooling	Digital control	Temperature from Modbus network	Analog control	 CFG
174	2-pipe	1-stage heating	2-stage cooling	Digital control	Temperature from Modbus network	1 speed	 CFG
175	2-pipe	1-stage heating	2-stage cooling	Digital control	Temperature from Modbus network	2 speeds	 CFG
176	2-pipe	1-stage heating	2-stage cooling	Digital control	Temperature from Modbus network	3 speeds	 CFG
177	2-pipe	1-stage heating	2-stage cooling	Analog control	iSMA-B-LP/Touch Point/FP room panel	Analog control	 CFG
178	2-pipe	1-stage heating	2-stage cooling	Analog control	iSMA-B-LP/Touch Point/FP room panel	1 speed	 CFG
179	2-pipe	1-stage heating	2-stage cooling	Analog control	iSMA-B-LP/Touch Point/FP room panel	2 speeds	 CFG
180	2-pipe	1-stage heating	2-stage cooling	Analog control	iSMA-B-LP/Touch Point/FP room panel	3 speeds	 CFG
181	2-pipe	1-stage heating	2-stage cooling	Analog control	Room sensor (SI3)	Analog control	 CFG
182	2-pipe	1-stage heating	2-stage cooling	Analog control	Room sensor (SI3)	1 speed	 CFG



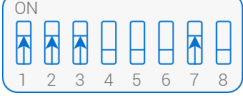







DIP Switch	1	2	3	4	5 & 6	7 & 8	
183	2-pipe	1-stage heating	2-stage cooling	Analog control	Room sensor (SI3)	2 speeds	
184	2-pipe	1-stage heating	2-stage cooling	Analog control	Room sensor (SI3)	3 speeds	
185	2-pipe	1-stage heating	2-stage cooling	Analog control	Returning air temperature sensor (SI1)	Analog control	
186	2-pipe	1-stage heating	2-stage cooling	Analog control	Returning air temperature sensor (SI1)	1 speed	
187	2-pipe	1-stage heating	2-stage cooling	Analog control	Returning air temperature sensor (SI1)	2 speeds	
188	2-pipe	1-stage heating	2-stage cooling	Analog control	Returning air temperature sensor (SI1)	3 speeds	
189	2-pipe	1-stage heating	2-stage cooling	Analog control	Temperature from Modbus network	Analog control	
190	2-pipe	1-stage heating	2-stage cooling	Analog control	Temperature from Modbus network	1 speed	
191	2-pipe	1-stage heating	2-stage cooling	Analog control	Temperature from Modbus network	2 speeds	
192	2-pipe	1-stage heating	2-stage cooling	Analog control	Temperature from Modbus network	3 speeds	









DIP Switch	1	2	3	4	5 & 6	7 & 8	
193	2-pipe	2-stage heating	1-stage cooling	Digital control	iSMA-B-LP/Touch Point/FP room panel	Analog control	 CFG
194	2-pipe	2-stage heating	1-stage cooling	Digital control	iSMA-B-LP/Touch Point/FP room panel	1 speed	 CFG
195	2-pipe	2-stage heating	1-stage cooling	Digital control	iSMA-B-LP/Touch Point/FP room panel	2 speeds	 CFG
196	2-pipe	2-stage heating	1-stage cooling	Digital control	iSMA-B-LP/Touch Point/FP room panel	3 speeds	 CFG
197	2-pipe	2-stage heating	1-stage cooling	Digital control	Room sensor (SI3)	Analog control	 CFG
198	2-pipe	2-stage heating	1-stage cooling	Digital control	Room sensor (SI3)	1 speed	 CFG
199	2-pipe	2-stage heating	1-stage cooling	Digital control	Room sensor (SI3)	2 speeds	 CFG
200	2-pipe	2-stage heating	1-stage cooling	Digital control	Room sensor (SI3)	3 speeds	 CFG
201	2-pipe	2-stage heating	1-stage cooling	Digital control	Returning air temperature sensor (SI1)	Analog control	 CFG
202	2-pipe	2-stage heating	1-stage cooling	Digital control	Returning air temperature sensor (SI1)	1 speed	 CFG

DIP Switch	1	2	3	4	5 & 6	7 & 8	
203	2-pipe	2-stage heating	1-stage cooling	Digital control	Returning air temperature sensor (S1)	2 speeds	
204	2-pipe	2-stage heating	1-stage cooling	Digital control	Returning air temperature sensor (S1)	3 speeds	
205	2-pipe	2-stage heating	1-stage cooling	Digital control	Temperature from Modbus network	Analog control	
206	2-pipe	2-stage heating	1-stage cooling	Digital control	Temperature from Modbus network	1 speed	
207	2-pipe	2-stage heating	1-stage cooling	Digital control	Temperature from Modbus network	2 speeds	
208	2-pipe	2-stage heating	1-stage cooling	Digital control	Temperature from Modbus network	3 speeds	
209	2-pipe	2-stage heating	1-stage cooling	Analog control	iSMA-B-LP/Touch Point/FP room panel	Analog control	
210	2-pipe	2-stage heating	1-stage cooling	Analog control	iSMA-B-LP/Touch Point/FP room panel	1 speed	
211	2-pipe	2-stage heating	1-stage cooling	Analog control	iSMA-B-LP/Touch Point/FP room panel	2 speeds	
212	2-pipe	2-stage heating	1-stage cooling	Analog control	iSMA-B-LP/Touch Point/FP room panel	3 speeds	

DIP Switch	1	2	3	4	5 & 6	7 & 8	
213	2-pipe	2-stage heating	1-stage cooling	Analog control	Room sensor (SI3)	Analog control	 CFG
214	2-pipe	2-stage heating	1-stage cooling	Analog control	Room sensor (SI3)	1 speed	 CFG
215	2-pipe	2-stage heating	1-stage cooling	Analog control	Room sensor (SI3)	2 speeds	 CFG
216	2-pipe	2-stage heating	1-stage cooling	Analog control	Room sensor (SI3)	3 speeds	 CFG
217	2-pipe	2-stage heating	1-stage cooling	Analog control	Returning air temperature sensor (SI1)	Analog control	 CFG
218	2-pipe	2-stage heating	1-stage cooling	Analog control	Returning air temperature sensor (SI1)	1 speed	 CFG
219	2-pipe	2-stage heating	1-stage cooling	Analog control	Returning air temperature sensor (SI1)	2 speeds	 CFG
220	2-pipe	2-stage heating	1-stage cooling	Analog control	Returning air temperature sensor (SI1)	3 speeds	 CFG
221	2-pipe	2-stage heating	1-stage cooling	Analog control	Temperature from Modbus network	Analog control	 CFG
222	2-pipe	2-stage heating	1-stage cooling	Analog control	Temperature from Modbus network	1 speed	 CFG

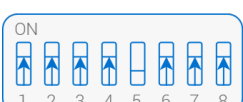
DIP Switch	1	2	3	4	5 & 6	7 & 8	
223	2-pipe	2-stage heating	1-stage cooling	Analog control	Temperature from Modbus network	2 speeds	 CFG
224	2-pipe	2-stage heating	1-stage cooling	Analog control	Temperature from Modbus network	3 speeds	 CFG
225	2-pipe	2-stage heating	2-stage cooling	Digital control	iSMA-B-LP/Touch Point/FP room panel	Analog control	 CFG
226	2-pipe	2-stage heating	2-stage cooling	Digital control	iSMA-B-LP/Touch Point/FP room panel	1 speed	 CFG
227	2-pipe	2-stage heating	2-stage cooling	Digital control	iSMA-B-LP/Touch Point/FP room panel	2 speeds	 CFG
228	2-pipe	2-stage heating	2-stage cooling	Digital control	iSMA-B-LP/Touch Point/FP room panel	3 speeds	 CFG
229	2-pipe	2-stage heating	2-stage cooling	Digital control	Room sensor (SI3)	Analog control	 CFG
230	2-pipe	2-stage heating	2-stage cooling	Digital control	Room sensor (SI3)	1 speed	 CFG
231	2-pipe	2-stage heating	2-stage cooling	Digital control	Room sensor (SI3)	2 speeds	 CFG
232	2-pipe	2-stage heating	2-stage cooling	Digital control	Room sensor (SI3)	3 speeds	 CFG

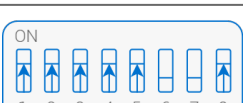
DIP Switch	1	2	3	4	5 & 6	7 & 8	
233	2-pipe	2-stage heating	2-stage cooling	Digital control	Returning air temperature sensor (S1)	Analog control	
234	2-pipe	2-stage heating	2-stage cooling	Digital control	Returning air temperature sensor (S1)	1 speed	
235	2-pipe	2-stage heating	2-stage cooling	Digital control	Returning air temperature sensor (S1)	2 speeds	
236	2-pipe	2-stage heating	2-stage cooling	Digital control	Returning air temperature sensor (S1)	3 speeds	
237	2-pipe	2-stage heating	2-stage cooling	Digital control	Temperature from Modbus network	Analog control	
238	2-pipe	2-stage heating	2-stage cooling	Digital control	Temperature from Modbus network	1 speed	
239	2-pipe	2-stage heating	2-stage cooling	Digital control	Temperature from Modbus network	2 speeds	
240	2-pipe	2-stage heating	2-stage cooling	Digital control	Temperature from Modbus network	3 speeds	
241	2-pipe	2-stage heating	2-stage cooling	Analog control	iSMA-B-LP/Touch Point/FP room panel	Analog control	
242	2-pipe	2-stage heating	2-stage cooling	Analog control	iSMA-B-LP/Touch Point/FP room panel	1 speed	

DIP Switch	1	2	3	4	5 & 6	7 & 8	
243	2-pipe	2-stage heating	2-stage cooling	Analog control	iSMA-B-LP/Touch Point/FP room panel	2 speeds	 CFG
244	2-pipe	2-stage heating	2-stage cooling	Analog control	iSMA-B-LP/Touch Point/FP room panel	3 speeds	 CFG
245	2-pipe	2-stage heating	2-stage cooling	Analog control	Room sensor (SI3)	Analog control	 CFG
246	2-pipe	2-stage heating	2-stage cooling	Analog control	Room sensor (SI3)	1 speed	 CFG
247	2-pipe	2-stage heating	2-stage cooling	Analog control	Room sensor (SI3)	2 speeds	 CFG
248	2-pipe	2-stage heating	2-stage cooling	Analog control	Room sensor (SI3)	3 speeds	 CFG
249	2-pipe	2-stage heating	2-stage cooling	Analog control	Returning air temperature sensor (SI1)	Analog control	 CFG
250	2-pipe	2-stage heating	2-stage cooling	Analog control	Returning air temperature sensor (SI1)	1 speed	 CFG
251	2-pipe	2-stage heating	2-stage cooling	Analog control	Returning air temperature sensor (SI1)	2 speeds	 CFG
252	2-pipe	2-stage heating	2-stage cooling	Analog control	Returning air temperature sensor (SI1)	3 speeds	 CFG





DIP Switch	1	2	3	4	5 & 6	7 & 8	
253	2-pipe	2-stage heating	2-stage cooling	Analog control	Temperature from Modbus network	Analog control	
254	2-pipe	2-stage heating	2-stage cooling	Analog control	Temperature from Modbus network	1 speed	
255	2-pipe	2-stage heating	2-stage cooling	Analog control	Temperature from Modbus network	2 speeds	
256	2-pipe	2-stage heating	2-stage cooling	Analog control	Temperature from Modbus network	3 speeds	

Table 8. All available DIP switch configurations