

# iSMA-B-LP

User Manual

## Modbus

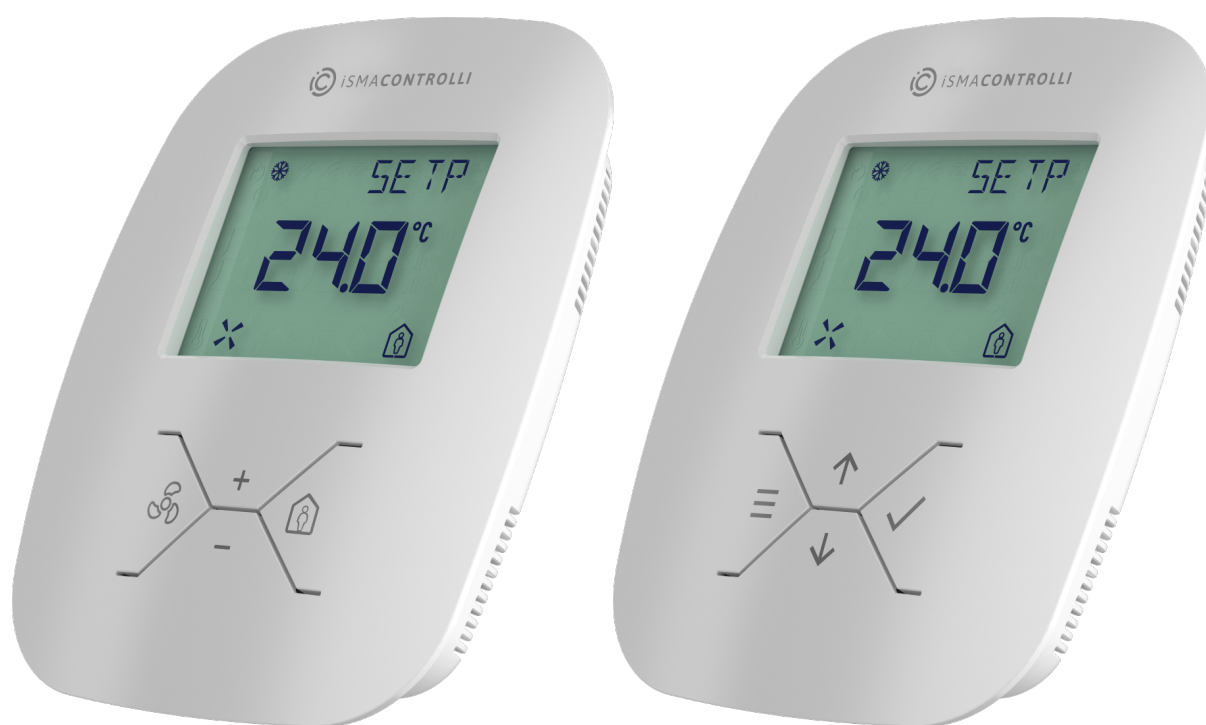

## Table of Contents

1	Introduction .....	6
1.1	Revision History.....	6
2	Safety Rules.....	8
3	Technical Specification .....	9
4	Hardware Specification .....	11
4.1	Room Panel Versions.....	11
4.2	Dimensions .....	12
4.3	Power Supply.....	13
4.3.1	DC Power Connection .....	14
4.3.2	AC Power Connection.....	14
4.4	Communication.....	14
4.4.1	RS485 Communication Bus Connection.....	14
4.4.2	Connecting Room Panels in the Network.....	14
4.4.3	RS485 Network Termination.....	15
4.5	USB Port.....	15
4.6	Restoring Default Settings.....	16
5	Main Parameters .....	17
5.1	PANEL_PASSWORD (40028).....	17
5.2	SUBMENU_PROTECTION (40228).....	17
5.3	Communication Parameters Configuration.....	17
5.3.1	COUNTER_OF_RECEIVED_MESSAGES (30004).....	17
5.3.2	COUNTER_OF_ERROR_MESSAGES (30006).....	17
5.3.3	COUNTER_OF_SENT_MESSAGES (30008) .....	17
5.3.4	BAUD_RATE (40017).....	18
5.3.5	STOP_BITS (40018) .....	18
5.3.6	PARITY_BIT (40020).....	18
5.3.7	RESPONSE_DELAY_TIME (40021).....	19
5.3.8	PANEL_ADDRESS (40023) .....	19
5.3.9	PROTOCOL (40024).....	19
5.4	Time Configuration.....	19
5.4.1	HOURS (40203) .....	20
5.4.2	MINUTES (40204).....	20
5.4.3	TIME_VISIBILITY (40218, Bit 0).....	20
5.4.4	ENTER_MENU_TIME (40223) .....	20
5.4.5	EXIT_EDIT_TIME (40224) .....	20

5.4.6	EXIT_MENU_TIME (40225).....	21
5.5	Device Configuration .....	21
5.5.1	VERSION_TYPE (30001) .....	21
5.5.2	LIVE_TIME (30012) .....	21
5.5.3	SENSORS (30029, Bits 0-2) .....	21
5.5.4	DEVICE_ACTIONS (40001).....	21
5.5.5	DEVICE CONFIGURATION REGISTER (40205).....	22
5.6	Room Panel Modes .....	24
5.7	LCD Display .....	24
5.7.1	Icons Display .....	25
5.7.2	Main Menu Display.....	27
5.8	Keypad.....	29
5.8.1	Menu Button.....	29
5.8.2	OK Button .....	29
5.8.3	Up and Down Buttons.....	29
5.8.4	Keypad Background Illumination Settings.....	29
6	Sensors .....	31
6.1	Temperature Sensor.....	31
6.1.1	TEMPERATURE_SENSOR_ACTUAL_VALUE (30301).....	31
6.2	Humidity Sensor .....	33
6.2.1	HUMIDITY_SENSOR_ACTUAL_VALUE (30302).....	33
6.3	CO2 Sensor .....	34
6.3.1	CO2_SENSOR_ACTUAL_VALUE (30303).....	34
7	Setpoints.....	37
7.1	SETPOINT_VALUE (41501) .....	37
7.2	EFFECTIVE_SETPOINT (31502) .....	37
7.3	DEFAULT_SETPOINT (41503) .....	37
7.4	OFFSET_SETPOINT (41504) .....	37
7.5	SETPOINT_LOW_LIMIT (41505).....	37
7.6	SETPOINT_HIGH_LIMIT (41506).....	37
7.7	OFFSET_RANGE (41507).....	37
7.8	SETPOINT_STEP (41508) .....	38
7.9	OFFSET_NAME (41509).....	38
7.10	SETPOINT_NAME (41511) .....	38
7.11	Configuration .....	38
7.11.1	SETPOINT CONFIGURATION (41513).....	38
7.12	Setting .....	42

7.12.1	OPERATING_MODE (41513).....	42
8	Fan.....	44
8.1	FAN_CURRENT_SPEED (41601).....	44
8.2	FAN_MODE (41602).....	44
8.3	FAN_TYPE (41603).....	45
8.4	FAN_MODE_NAME (41604-41612).....	46
8.5	Configuration.....	46
8.5.1	FAN_CONFIGURATION (41614).....	46
8.5.2	FAN_ICON_FLASHING_TIME (41615).....	48
9	Occupancy.....	49
9.1	OCCUPANCY_CURRENT_STATUS (41701).....	49
9.2	OCCUPANCY_MODE (41702).....	49
9.3	OCCUPANCY_MODE_NAME (41703, 41705).....	49
9.4	Configuration.....	50
9.4.1	OCCUPANCY_CONFIGURATION (41707).....	50
10	Registers Adjustable Locally from the Room Panel.....	52
10.1	Room Panel Settings.....	52
10.1.1	Configuration (CONF).....	52
10.1.2	Device (DEV).....	53
10.1.3	Temperature (TEMP).....	54
10.1.4	Humidity (HUM).....	54
10.1.5	CO2 (CO2).....	55
10.1.6	Setpoint (SETP).....	55
10.1.7	Fan (FAN).....	56
10.1.8	Occupancy (OCCU).....	57
11	Main Menu User-defined Parameters.....	58
12	Submenu User-defined Parameters.....	59
12.1	Numeric Parameters Registers.....	59
12.1.1	XPresentValue (X = [1.8]).....	59
12.1.2	XName (X = [1.8]).....	59
12.1.3	XPriority (X = [1.8]).....	59
12.1.4	XStep (X = [1.8]).....	60
12.1.5	XLowLimit (X = [1.8]).....	60
12.1.6	XHighLimit (X = [1.8]).....	60
12.1.7	XConfiguration (X = [1.8]).....	60
12.2	Boolean Parameters Registers.....	61



12.2.1	XPresentValue (X = [1.8]).....	62
12.2.2	XName (X = [1.8]) .....	62
12.2.3	XTrueText (X = [1.8]).....	62
12.2.4	XFalseText (X = [1.8]).....	62
12.2.5	XPriority (X = [1.8]).....	62
12.2.6	XConfiguration (X = [1.8]).....	63
12.3	MenuActivePoints Registers.....	63
12.4	Boolean PresentValue Registers (40107-40113).....	63
13	List of Modbus Registers .....	64
13.1	List of User-defined Parameters Modbus Registers.....	74
13.1.1	Main Menu User-defined Parameters Registers .....	74
13.1.2	Temperature Submenu Registers .....	82
13.1.3	Fan Submenu Registers .....	93
13.1.4	Light Submenu Registers.....	103
13.1.5	Blind Submenu Registers .....	114
13.1.6	Alarms Submenu Registers.....	124
13.1.7	Occupancy Submenu Registers .....	135

## 1 Introduction

The iSMA-B-LP is a wall panel with 2.3" LCD display and four function buttons. Additionally, the panel has a built-in temperature sensor and, optionally, humidity and CO<sub>2</sub> sensors.

The iSMA-B-LP is powered with 24 V AC/DC and has a built-in RS485 port (Modbus RTU/ASCII and BACnet MS/TP). The use of open communication protocol allows to connect the panel with any controller, which supports Modbus RTU/ASCII or BACnet MS/TP. Connected to the iSMA controllers, the panel allows to change the basic parameters such as: temperature setpoint, fan speed, FCU mode, and other. Thanks to a built-in USB port, there is a possibility of updating firmware and configuring the panel without the need of power supply. The iSMA-B-LP has modern design and is available in different colors (white is basic), on client's request.

This user manual outlines Modbus registers available in the iSMA-B-LP room panel and describes their configuration.



Table 1. LP panels

### 1.1 Revision History

Rev.	Date	Description
1.0	28 Aug 2016	First edition
1.1	21 Feb 2017	New function: <ul style="list-style-type: none"> <li>Added SubmenulconDisplayOFF bit in DeviceConfiguration register to disable displaying of Submenu Icons;</li> </ul> Changes in Document: <ul style="list-style-type: none"> <li>Added SubmenulconDisplayOFF bit description in DeviceConfiguration section</li> <li>Added description of Submenu Boolean All present Value registers</li> </ul>
1.2	6 Jun 2017	Added information about BACnet MS/TP protocol

Rev.	Date	Description
1.3	16 Nov 2017	Added new version of the Panel (iSMA-B-LP(-XX)-1)
1.4	25 May 2022	Rebranded

*Table 2. Revision history*

This user manual outlines Modbus registers available in the iSMA-B-LP room panel and describes their configuration.

## 2 Safety Rules

- Improper wiring of the product can damage it and lead to other hazards. Make sure that the product has been correctly wired before turning the power on.
- Before wiring or removing/mounting the product, make sure to turn the power off. Failure to do so might cause an electric shock.
- Do not touch electrically charged parts such as power terminals. Doing so might cause an electric shock.
- Do not disassemble the product. Doing so might cause an electric shock or faulty operation.
- Use the product only within the operating ranges recommended in the specification (temperature, humidity, voltage, shock, mounting direction, atmosphere, etc.). Failure to do so might cause a fire or faulty operation.
- Firmly tighten the wires to the terminal. Failure to do so might cause a fire.
- Avoid installing the product in close proximity to high-power electrical devices and cables, inductive loads, and switching devices. Proximity of such objects may cause an uncontrolled interference, resulting in an instable operation of the product.
- Proper arrangement of the power and signal cabling affects the operation of the entire control system. Avoid laying the power and signal wiring in parallel cable trays. It can cause interferences in monitored and control signals.
- It is recommended to power controllers/modules with AC/DC power suppliers. They provide better and more stable insulation for devices compared to AC/AC transformer systems, which transmit disturbances and transient phenomena like surges and bursts to devices. They also isolate products from inductive phenomena from other transformers and loads.
- Power supply systems for the product should be protected by external devices limiting overvoltage and effects of lightning discharges.
- Avoid powering the product and its controlled/monitored devices, especially high power and inductive loads, from a single power source. Powering devices from a single power source causes a risk of introducing disturbances from the loads to the control devices.
- If an AC/AC transformer is used to supply control devices, it is strongly recommended to use a maximum 100 VA Class 2 transformer to avoid unwanted inductive effects, which are dangerous for devices.
- Long monitoring and control lines may cause loops in connection with the shared power supply, causing disturbances in the operation of devices, including external communication. It is recommended to use galvanic separators.
- To protect signal and communication lines against external electromagnetic interferences, use properly grounded shielded cables and ferrite beads.
- Switching the digital output relays of large (exceeding specification) inductive loads can cause interference pulses to the electronics installed inside the product. Therefore, it is recommended to use external relays/contactors, etc. to switch such loads. The use of controllers with triac outputs also limits similar overvoltage phenomena.
- Many cases of disturbances and overvoltage in control systems are generated by switched, inductive loads supplied by alternating mains voltage (AC 120/230 V). If they do not have appropriate built-in noise reduction circuits, it is recommended to use external circuits such as snubbers, varistors, or protection diodes to limit these effects.

### 3 Technical Specification

Power Supply	Voltage	24 V AC/DC $\pm$ 20%
	Power Consumption	iSMA-B-LP(-1): 0.5 W (24 V DC), 0.75 VA (24 V AC) iSMA-B-LP-H(-1): 0.5 W (24 V DC), 0.75 VA (24 V AC) iSMA-B-LP-C(-1): 0.7 W (24 V DC), 1 VA (24 V AC) iSMA-B-LP-HC(-1): 0.7 W (24 V DC), 1 VA (24 V AC)
Built-in Sensors	Temperature Sensor	10k NTC type Accuracy: $\pm$ 0.5°C Range: 0-50°C Resolution: $\pm$ 0.1°C
	Humidity Sensor	Range: 0-100% RH Accuracy: $\pm$ 2% RH in range 20-80% RH Resolution: $\pm$ 1% RH
	CO <sub>2</sub> Sensor	Method Non Dispersive Infrared (NDIR), gold plated optics, diffusion sampling (with Telaire's Patented ABC Logic Self Calibrated Algorithm) Range: 400-2000 ppm Accuracy: $\pm$ 30 ppm OR $\pm$ 3% of reading Stability: < 2% of FS over life of sensor (15 years typical) Warm-up Time : < 2 minutes (operational); 10 minutes (maximum accuracy) Calibration: ABC Logic Algorithm Manual Calibration Interval: Not required
RS485 Interface	Communication Protocols	Modbus RTU, Modbus ASCII, BACnet MS/TP
	Baud rate	From 4800 to 115200 bps
USB	USB	Mini USB, type B
Environment	Ingress Protection	IP40
Temperature	Storage	-40°C to +85°C
	Operating	0°C to +50°C
Humidity	Relative	5% to 95%
Platform		ARM Cortex - M0+

Housing		Construction: plastic, self-extinguishing (PC/ABS) Wall mounting (standard electric box) Cooling: internal air circulation
Dimensions	Width	100 mm
	Length	27 mm
	Height	123 mm

*Table 3. Technical specification*

## 4 Hardware Specification

The iSMA-B-LP is a wall panel with 2.3" LCD display and four function buttons. Additionally, the panel has a built-in temperature sensor and, optionally, humidity and CO<sub>2</sub> sensors.

The iSMA-B-LP is powered with 24 V AC/DC and has a built-in RS485 port (Modbus RTU/ASCII and BACnet MS/TP). The use of open communication protocol allows to connect the panel with any controller, which supports Modbus RTU/ASCII or BACnet MS/TP. Connected to the iSMA controllers, the panel allows to change the basic parameters such as: temperature setpoint, fan speed, FCU mode, and other. Thanks to a built-in USB port, there is a possibility of updating firmware and configuring the panel without the need of power supply. The iSMA-B-LP has modern design and is available in different colors (white is basic), on client's request.

### 4.1 Room Panel Versions

The iSMA-B-LP room panels are available in four different configurations, depending on installed sensors, available parameters, and settings.

All possible sensors' configuration versions are listed in the table below.

Ordering	Temperature	Humidity	CO2
iSMA-B-LP(-1)	✓		
iSMA-B-LP-H(-1)	✓	✓	
iSMA-B-LP-C(-1)	✓		✓
iSMA-B-LP-HC(-1)	✓	✓	✓

Table 4. Room panel versions of sensors configuration

Each of the available room panel versions can be equipped with either one variant of the keypad icons set:

- standard (fan/occupancy menu icons, plus/minus selecting icons) and
- optional (menu/check icons, up and down arrows selecting icons).

The ordering code for a standard keypad icons set panel version is iSMA-B-LP(-XX) (on the left), and for the optional icons set is iSMA-B-LP(-XX)-1 (on the right).



## 4.2 Dimensions



Figure 1. Front dimensions

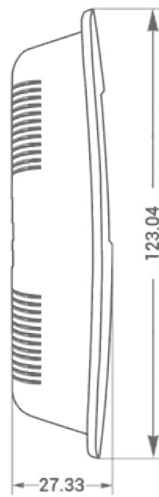

Figure 2. Side dimensions

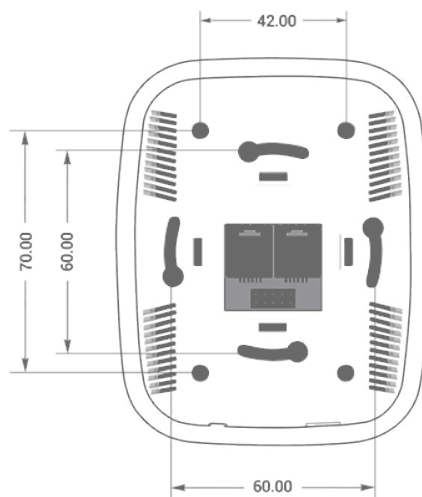

Figure 3. Back dimensions



### 4.3 Power Supply

The iSMA-B-LP room ranel is powered with 24 V AC/DC. The power consumption depends on the power supply voltage type used and the fact whether the CO<sub>2</sub> sensor is installed (see the [technical specification](#)). There are two RJ12 sockets mounted on the back side of the room panel. Each RJ12 socket has the same internal connection and functionality. Two RJ12 sockets allow for using in and out connections for other devices in the network.

The power supply can be connected through the RJ12 connector as shown in the figure below.

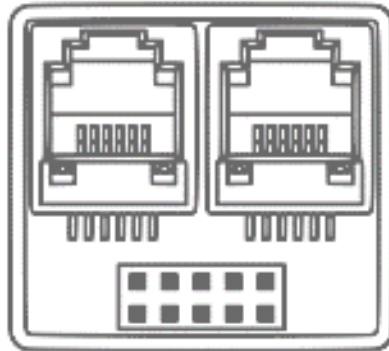

Figure 4. RJ12 sockets

There are two pairs of pins for the 24 V AC/DC power supply connection (+24 V DC pins 5 and 6, grounding pins 1 and 4). These pin pairs can be used freely. It is especially useful if different types of connection cables are used (4 or 6 core). It is possible to use a single cable with RJ12 connectors for the power supply and RS485 communication. Pins 2 and 3 are dedicated for the RS485 communication connection.

The room panel exchanges data with other devices through Modbus protocol (RTU/ASCII) and BACnet MS/TP.

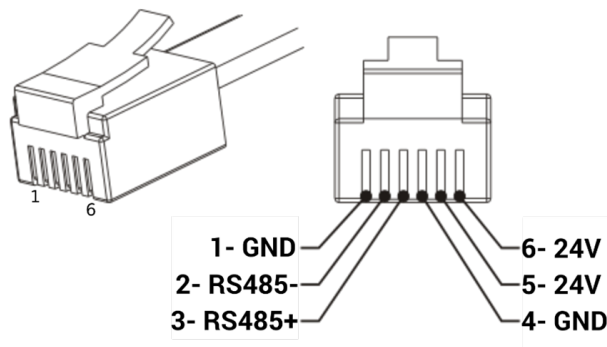

Figure 5. RJ12 pins

**WARNING!** In case of the RS485 connection, pay attention to a standard polarization. Connect RS485+ to pin 3 and RS485- to pin 2, as shown in the figure 4 above.

### 4.3.1 DC Power Connection

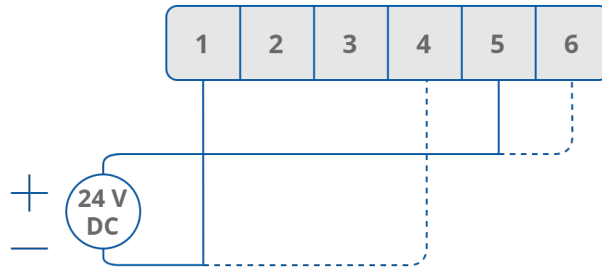

Figure 6. DC power connection

### 4.3.2 AC Power Connection

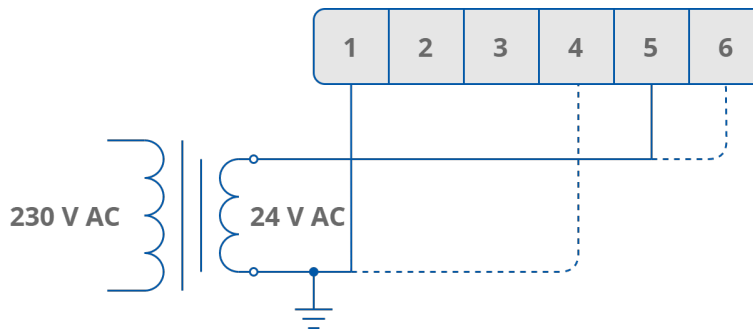

Figure 7. AC power connection

## 4.4 Communication

### 4.4.1 RS485 Communication Bus Connection

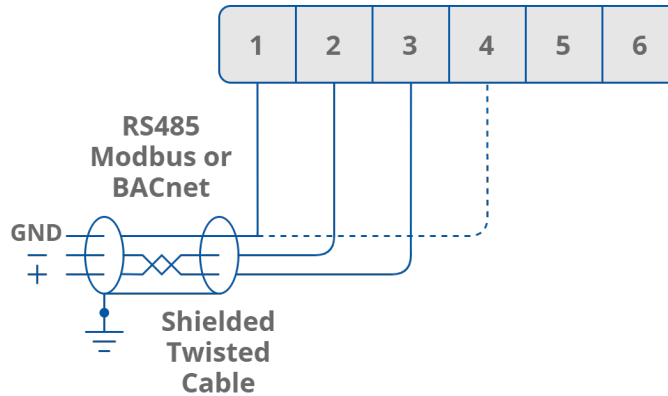

Figure 8. RS485 communication bus connection

### 4.4.2 Connecting Room Panels in the Network

It is possible to connect more than one room panels into the one network in a very simple way. An additional RJ12 socket can be used to connect another room panel by using one single cable. Every panel can exchange information within the network. The solution can be applied in large areas, when more than one room panels are needed. The maximum number of devices connected in one network is 128.

**WARNING!** The first and last device in the network need to have termination activated.

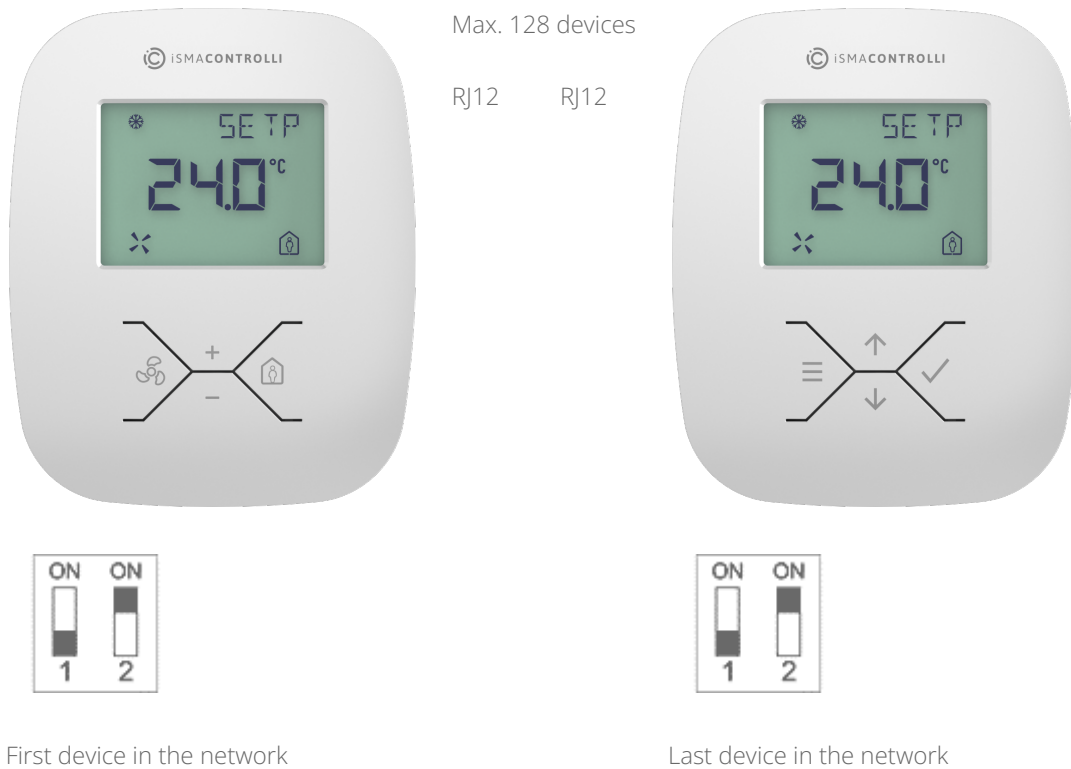

Table 5.

### 4.4.3 RS485 Network Termination

Transmission line effects often present a problem for data communication networks. These problems include reflections and signal attenuation.

To eliminate the presence of reflections of signal from the end of the cable, the cable must be terminated at both ends with a resistor across the line adequate to its characteristic impedance. Both ends must be terminated since the propagation is bidirectional. In case of an RS485 twisted pair cable this termination is typically 120 Ω.

Each panel has a built-in termination resistor, which can be added to the network by setting the DIP-switch no. 2 to the ON position. The last and first room panels in the network need to have the termination activated.

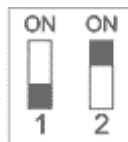

Figure 9. Connecting a termination resistor by DIP switch no. 2

### 4.5 USB Port

The USB connection is dedicated for maintenance and settings.

The USB port (mini type B) is located at the bottom of the device.

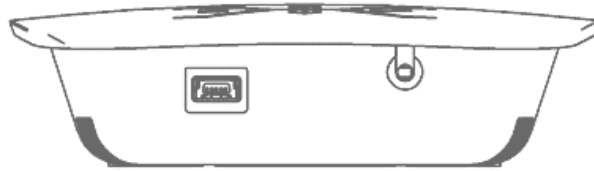

Figure 10. USB port

The USB connection provides the power supply for the room panel (+5 V DC), therefore there is no need for additional power supply in this connection type.

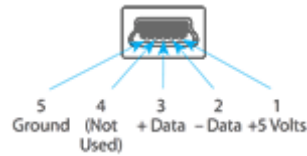

Figure 11. Mini USB pinout

## 4.6 Restoring Default Settings

To restore the default configuration of all registers, follow the below steps:

- Turn the power supply off.
- Set the DIP switch no. 1 to the ON position.



Figure 12. Position of the DIP switch no. 1 for restoring default settings

- Turn the power supply on, the LCD display starts blinking.
- Set the DIP switch no. 1 to the OFF position to restore the default settings. To cancel the reset, turn the power off and set the DIP switch no. 1 to OFF.

Register Name	Default Value
BAUD_RATE	11520 (115200 bps)
STOP_BITS	1
DATA_BITS	8
PARITY_BITS	0
ADDRESS	1
PROTOCOL	0 (Modbus RTU)

Table 6. Default communication settings

## 5 Main Parameters

### 5.1 PANEL\_PASSWORD (40028)

The register defines a password, which is necessary to locally enter submenus and configuration menus from the Room Panel (PIN code). The default password is 1000.

### 5.2 SUBMENU\_PROTECTION (40228)

After activation of a particular bit of the register set, a password prevents access to different submenu editions (see the table below).

The function allows for block changing of parameters inside each submenu. It can be useful especially in areas where Room Panel is vulnerable and subject to unauthorized interaction (common areas).

In the default setting all bits are inactive (access to each submenu is unprotected).

Register Bit No.	Name	Inactive State	Active State	Submenu Protection
0	Temperature	OFF(def)	ON	Temperature Submenu
1	Fan	OFF(def)	ON	Fan Submenu
2	Light	OFF(def)	ON	Light Submenu
3	Blind	OFF(def)	ON	Blind Submenu
4	Alarms	OFF(def)	ON	Alarms Submenu
5	Occupancy	OFF(def)	ON	Settings Submenu

Table 7. The SUBMENU\_PROTECTION register structure

## 5.3 Communication Parameters Configuration

### 5.3.1 COUNTER\_OF\_RECEIVED\_MESSAGES (30004)

The 32-bit register with the number of valid Modbus messages received by the room panel from the time of the last power-up. The value is reset after power cycle or after changing of transmission parameters (speed, stop bits, parity, etc.).

### 5.3.2 COUNTER\_OF\_ERROR\_MESSAGES (30006)

The 32-bit register with the number of error Modbus messages received by the room panel from the time of the last power-up. The value is reset after power cycle or after changing of transmission parameters (speed, stop bits, parity, etc.).

### 5.3.3 COUNTER\_OF\_SENT\_MESSAGES (30008)

The 32-bit register with the number of Modbus messages sent by the room panel from the time of the last power-up. The value is reset after power cycle or after changing transmission of parameters (speed, stop bits, parity, etc.).

### 5.3.4 BAUD\_RATE (40017)

The actual baud rate in bps divided by 10. By default: 11520 (115200 bps).

Value	Baud Rate
480	4800
960	9600
1920	19200
3840	38400
5760	57600
11520	115200(def)

Table 8. Baud rate

### 5.3.5 STOP\_BITS (40018)

The number of stop bits is determined on the basis of this register in accordance with the following table:

Value	No. of Stop Bits
1	1(default)
2	2

Table 9. Stop bits

### 5.3.6 PARITY\_BIT (40020)

Each byte of data being transferred may have additional protection of a parity bit added before stop bit (bits).

The method of calculating parity bit determines the below table:

Register Value	Type of Parity Bit
0	None(def)
1	Odd (number of all ones in a byte is odd)
2	Even (number of all ones in a byte is even)

Table 10. Parity bits

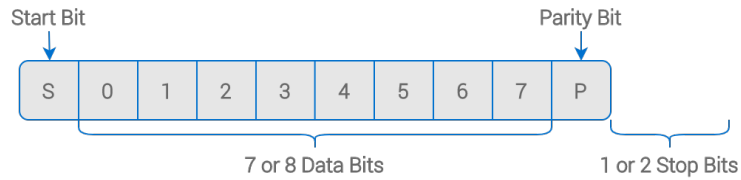

Figure 13. Modbus message frame

### 5.3.7 RESPONSE\_DELAY\_TIME (40021)

The value of this 16-bit register determines the number of milliseconds to wait before the unit answers the question. This time is used to extend the interval between the question and the answer.

The default value of 0 means no delay (the answer is sent once during the 3.5 character required by the protocol Modbus RTU).

### 5.3.8 PANEL\_ADDRESS (40023)

This register contains information about the Modbus address of the room panel.

The default address is 1.

### 5.3.9 PROTOCOL (40024)

The register is responsible for the protocol selection. The protocol is determined according to the register value as shown in the following table:

Value	Action
0	Modbus RTU(def)
1	Modbus ASCII
2	BACnet MS/TP

Table 11. Protocol selection

## 5.4 Time Configuration

The time (if activated) is displayed on the 14-segment display block. After restart of the device the clock is not displayed. It starts to be visible after the Room Panel receives first message with a correct time value.

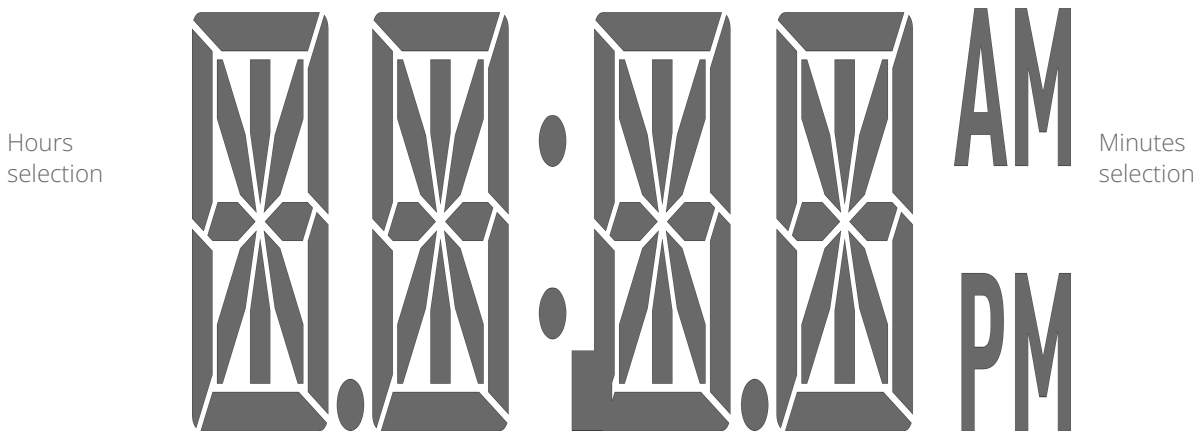

Table 12. 14-segment display block for displaying time

### 5.4.1 HOURS (40203)

The register contains actual hour value in a time displaying mode. 12h/24h mode is determined by the DEVICE\_CONFIGURATION register (the default mode is 24 h). When the clock is set in 12h format, icons AM and PM are displayed automatically. A semicolon, which separates hours and minutes sections, flashes with 1 Hz frequency.

### 5.4.2 MINUTES (40204)

The register contains actual minute value in a time displaying mode.

### 5.4.3 TIME\_VISIBILITY (40218, Bit 0)

The bit 0 of the 40218 register determines the time visibility. If the bit 0 is true, the clock is visible in the main menu (it starts to be visible when the Room Panel receives a first message with a correct time value after panel restart or connection of power supply). The clock is displayed on 14-segment display block when the name of active parameter (visible) is empty (each character in the parameter name is NULL). The default value is true (visible).

### 5.4.4 ENTER\_MENU\_TIME (40223)

When the Menu button is pushed longer than the time value stored in the ENTER\_MENU\_TIME register, the user enters the Submenu Edit mode.

When the Menu button is pushed together with OK button longer than the time value stored in the ENTER\_MENU\_TIME register, the user enters the Settings Submenu Edit mode. This register has min. value of 1 sec. The default value is 2 sec.

### 5.4.5 EXIT\_EDIT\_TIME (40224)

The register contains the time after which an edition of any editable parameter is finished. Time starts after the last key pad activation (pushing any button during Edit mode). This register has min. value 1 sec. The default value is 5 sec.



## 5.4.6 EXIT\_MENU\_TIME (40225)

The register contains the time value after which the Submenu Edit mode and Settings Submenu Edit mode are finished, and the device leads the user back to the main menu display. Time starts after the last key pad activation (pushing any button). This register has min. value 1 sec. The default value is 10 sec.

## 5.5 Device Configuration

### 5.5.1 VERSION\_TYPE (30001)

In this register the type and module firmware version are encoded.

High byte contains information about the type (room panel has a version  $111_{10}$  (0x6F<sub>16</sub>) or  $239_{10}$  (0xEF<sub>16</sub>) when the device stays in bootloader).

Low byte contains the module firmware version multiplied by 10 ( $0x0A_{16} = 10_{10}$  means firmware in version 1.0).

For example:

The register 30001 contains a number  $2671_{10} = 0x0A6F_{16}$ . This means that it is a room panel with a firmware version 1.0 ( $0x0A_{16} = 10_{10}$ ).

### 5.5.2 LIVE\_TIME (30012)

This 32-bits register contains information about the uptime, expressed in seconds. After power supply failure or the panel restart LIVE\_TIME register value resets and the uptime is counted again.

### 5.5.3 SENSORS (30029, Bits 0-2)

This register contains information about the sensors built-in the the room panel. The sensors configuration is encoded in the 3 first bits of the register. The activity status of a particular bit indicates which sensor is installed (see table below).

Register Bit No.	Inactive State	Active State	Sensors
0	No sensor	Built-in	Temperature Sensor
1	No sensor	Built-in	CO <sub>2</sub> sensor
2	No sensor	Built-in	Humidity sensor

Table 13. Sensors configuration

### 5.5.4 DEVICE\_ACTIONS (40001)

Setting register 40001 according to the table below enables 1 of 4 available actions: reset device, reload settings, reset settings, or enter bootloader.

Register Value Decimal	Register Value Hexadecimal	Action
511	0x01FF	Reset
767	0x02FF	Reload settings
1023	0x03FF	Reset settings
1279	0x04FF	Enter bootloader

Table 14. Device actions

## 5.5.5 DEVICE CONFIGURATION REGISTER (40205)

### BEEPER (40205, Bit 0)

The bit 0 of the register 40205 activates or deactivates the beeper. When the beeper is active, any single pushing of any button is signaled by the beeper sound. In addition, the beeper can be also used for CO2 alarm signalization. By default, the beeper is active (bit 1 is true).

### TIME\_FORMAT (40205, Bit 1)

The bit 1 of the register 40205 defines a time format display. When the bit is true, the time is set in 12h format. Otherwise, the time is displayed in 24h format (default).

When the clock is set in 12h format and it receives hours value in 24h format, icons AM and PM are displayed according to calculation. A semicolon, which separates hours and minutes sections in the clock, flashes with 1 Hz frequency.

### BACKGROUND\_ILLUMINATION\_LCD\_ACTIVE (40205, Bit 3)

The bit 3 of the register 40205 switches the LCD background illumination on. When the bit 3 is true, the LCD display is illuminated with intensity according to values stored in registers dedicated for particular room panel modes. If the bit 3 is false, the LCD display is not illuminated in any mode. By default, the bit 3 is true.

### BACKGROUND\_ILLUMINATION\_KEY\_PAD\_ACTIVE (40205, Bit 4)

The bit 4 of the register 40205 switches the keypad background illumination on. When the bit 4 is true, the key pad is illuminated with intensity according to values stored in registers dedicated for particular room panel modes. If the bit 4 is false, the keypad is not illuminated in any mode. By default, the bit 4 is false (keypad not illuminated).

### CO2\_IN\_ALARM\_FLASHING\_LCD (40205, Bit 5)

The bit 5 of the register 40205 switches on the function of LCD background illumination flashing when CO2 alarm occurs. If the bit 5 is true, the CO2 alarm is indicated by the LCD display flashing. Read more about CO2 alarm in the [CO2 sensor](#) section. By default, the bit 5 is false (function deactivated).

### **CO2\_IN\_ALARM\_BUZZER (40205, Bit 6)**

The bit 6 of the register 40205 switches the buzzer on when the CO2 alarm occurs. If the bit 6 is true, the CO2 alarm is indicated by the beeper, which emits sounds with 1 Hz frequency. Read more about CO2 alarm in the [CO2 sensor](#) section. By default, the bit 6 is false (function deactivated).

### **CO2\_IN\_ALARM\_SHOW\_HIGH (40205, Bit 7)**

The bit 7 of the register 40205 switches on a “HIGH” label on display when the CO2 alarm occurs. If the bit 7 is true and the CO2 alarm is active, the LCD display shows CO2 sensor actual value on the 8-segment displays block and a blinking text “HIGH” on the 14-segment displays block. By default, the bit 7 is false (function deactivated).

### **SUBMENU\_ICON\_DISPLAY\_OFF (40205, Bit 10)**

The bit 10 of the register 40205 switches the submenu icon display off. If the bit 10 is true, all submenu icons are hidden, even in case when one or more submenus contain active points. The user can enter an active submenu (with at least one active point) and proceed normal operation but its icon is invisible in the main menu display view.

### **PANEL\_OFF (40205, Bit 11)**

The bit 11 of the register 40205 switches the panel off. If the bit 11 is true, the room panel is inactive. It means that it is impossible to control the room panel locally (access to submenus and parameters configuration is blocked—keypad is deactivated). The LCD display and background illumination are also off. The main menu is not displayed. The room panel works as temperature sensor (or multisensor if either the CO2 sensor or humidity sensor are built-in). If the bit 11 is false, the room panel works in normal mode (functions of local control are active). By default, the bit 11 is false (panel is on).

### **KEY\_PAD\_OFF (40205, Bit 12)**

The bit 12 of the register 40205 switches the panel keypad off. If the bit 12 is active, the keypad function is deactivated. Single pushing of any button emits a beeper sound (if beeper is activated) and activates the active mode (set background illumination level) but the submenu access is blocked (it is impossible to enter any menu or to change any parameters or settings). The main menu is displayed. By default, the bit 12 is false (keypad is on).

### **LCD\_FLASHING (40205, Bit 13)**

The bit 13 of the register 40205 is responsible for the LCD display flashing activation. If the bit 13 is true, the LCD display flashes with the frequency stored in the LCDIconFlashing register. Flashing brightness level changes from 0% to maximum value from the registers:

BACKGROUND ILLUMINATION LCD FOR ACTIVE MODE register

BACKGROUND ILLUMINATION LCD FOR IDLE MODE register

BACKGROUND ILLUMINATION LCD FOR STANDBY MODE register

By default, the bit 13 is false (LCD flashing inactive).

## KEY\_PAD\_FLASHING (40205, Bit 14)

The bit 14 of the register 40205 is responsible for the keypad flashing activation. If the bit 14 is true, the keypad flashes with the frequency stored in the LCDIconFlashing register. Flashing brightness level changes from 0% to maximum value from the registers:

BACKGROUND ILLUMINATION KEY PAD FOR ACTIVE MODE register

BACKGROUND ILLUMINATION KEY PAD FOR IDLE MODE register

BACKGROUND ILLUMINATION KEY PAD FOR STANDBY MODE register

By default, the bit 14 is false (keypad flashing inactive).

## 5.6 Room Panel Modes

The Room Panel operates in 3 different modes:

- Active mode;
- Idle mode;
- Stand-by mode.

The differences between particular modes are physically visible when all the below conditions are fulfilled:

1. Bit 11 of the DEVICE\_CONFIGURATION register is true (panel is on).
2. Bit 4 of the DEVICE\_CONFIGURATION register is true (keypad illumination active).
3. Bit 3 of the DEVICE\_CONFIGURATION register is true (LCD illumination active).
4. There are different values in the registers responsible for the illumination level of different modes (see the [Device Configuration](#)).

Each mode determines LCD and keypad background illumination intensity.

The actual room panel mode depends on the keypad activity (pushing buttons) and time values set by appropriate registers. The user can also control illumination intensity of each mode by entering appropriate values to assigned registers.

## 5.7 LCD Display

The iSMA-B-LP room panel is equipped with 2.3" LCD display with backlight.

By default, the LCD display is turned on (when the device is powered) and basic parameters from in-built sensors together with the user-defined parameters are shown in the main menu.

The register DEVICE\_CONFIGURATION bit 11 is responsible for the LCD display and keypad activation.

If the bit is false, the LCD display and keypad work in normal mode (parameters and actual sensor values are displayed, submenus are visible and editable, etc.).

If the bit is true, the LCD display and keypad are deactivated. The room panel works as a simple sensor. (CO<sub>2</sub> sensor, temperature sensor, humidity sensor—depending on the room panel version).

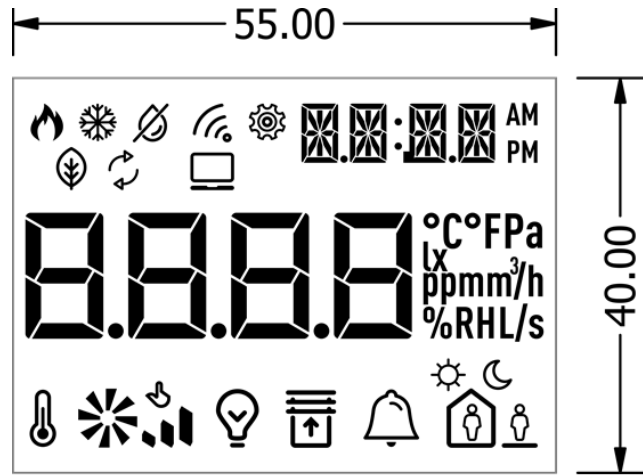

Figure 14. The ICD display general view

### 5.7.1 Icons Display

There are many different icons which are available on the panel display. The user can choose which icon is dedicated for visualization of a particular process. Every single icon can be controlled by a higher level system. There are two Modbus registers which are responsible for icon indication.

#### LCD\_ICON\_DISPLAY (40219)

Each bit of the register is responsible for displaying a particular icon.

Setting true value to a single bit displays an appropriate icon which is assigned to that bit according to the table below. By default, all icons are hidden (all bits of the register are false).

#### LCD\_ICON\_FLASHING (40220)

Each bit of the register switches on blinking of particular icons.

Setting true value for a particular bit causes blinking of a single icon which is assigned to that bit according to the table below.

Bit	Icon Name	Icon
0	Sun	
1	Moon	
2	Heating	
3	Cooling	
4	Humidfire	
5	Dehumidfire	





Bit	Icon Name	Icon
6	Wireless	
7	Settings	
8	Eco	
9	Recirculation	
10	PC	

Table 15. LCD icons









### LCD\_ICON\_FLASHING\_TIME (40221)

It is possible to set the icon blinking frequency. The register LCD\_ICON\_FLASHING\_TIME stores the time which constitutes the base for calculating the icon blinking frequency. This register has min. value of 50 ms. The default value is 500 ms (the icons are visible for 500 ms and hidden for  $500/4=125$  ms).

### SUBMENU\_ICON\_FLASHING (40229)

Each bit of the register switches on blinking of particular submenu icons.

Setting true value for a particular bit causes blinking of a single icon which is assigned to that bit according to the table below.

Bit	Icon Name	Icon
0	Temperature	
1	Fan 1	
2	Fan 2	
3	Fan 3	
4	Fan 4	
5	Fan 5	
6	Fan 6	
7	Light	





Bit	Icon Name	Icon
8	Blind	
9	Alarms	
10	Occupancy 1	
11	Occupancy 2	
12	Occupancy 3	

Table 16. Submenu icons

## SUBMENU\_ICON\_FLASHING\_TIME (40222)

The submenu icons light up according to the status of assigned process. These icons are not editable, however, the user can choose if each submenu icon is to be visible or not. The register SUBMENU\_ICON\_FLASHING\_TIME stores the time which constitutes the base for calculating a frequency of submenu icons flashing. This register has min. value of 50 ms. The default value is 1000 ms (the icons are visible for 1000 ms and hidden for  $1000/4=250$  ms).

## 5.7.2 Main Menu Display

The main part of the display shows current sensor values, the setpoint value, and user-defined parameters with assigned units. The user can determine, whether a particular actual sensor value or the actual setpoint value is to be shown or not. Chosen values are displayed one after another repeatedly.

## REFRESHING\_TIME (40217)

Duration of the display time of the particular parameter is set in the REFRESHING\_TIME register. When the refreshing time elapses, the next parameter is displayed according to the sequence of parameters display. The default value is 2 sec. (each parameter is displayed for 2 seconds). This register has a min. value of 1 second.

Sequence of parameters display:

1. Actual value of the temperature sensor (if active);
2. Actual value of the humidity sensor (if active);
3. Actual value of the CO<sub>2</sub> sensor (if active);
4. Temperature Setpoint (if active);
5. User-defined parameter with the highest priority;
6. ....
7. User-defined parameter with the lowest priority.

The parameters are shown on the 8-segment display block according to the type of the parameter:

1. For numeric type parameter: value of the parameter and the unit (defined by user) is displayed.
2. For Boolean type parameter: text (defined by user), which corresponds to actual logic state is displayed.

After the room panel restart, user-defined parameters are not displayed until they become overwritten from a higher level system.

If only one parameter is active, its value is refreshed with an interval stored in the REFRESHING\_TIME register.

If one or more user-defined parameters have the same priority, register with the lowest address is displayed first.

In the upper right corner of the display there are four 14-segment displays dedicated for the clock, submenu, and parameters' names. These names are stored in the special submenu registers as ASCII code values corresponding to the following characters (from the left side) of the submenu name. In case when a character value equals  $0_{10}=0x00_{16}$ (NULL), the character is hidden (not displayed). If all characters of particular parameter name are NULL, then the clock is displayed (if active).

## LCD\_BACKGROUND\_ILLUMINATION\_SETTINGS

If one of four keypad buttons is pressed, the room panel changes its state into the Active mode.

The same situation happens when the power supply is reconnected or after the room panel restart.

In case when there is no keypad activity and the room panel stays on, the subsequent background illumination modes activate. The LCD display illuminates only when a value of the DEVICE\_CONFIGURATION register bit 3 is true. If not, the LCD display is never illuminated.

Particular modes activate sequentially according to the following sequence:

- Active: the mode activates after pressing any keypad button or after restart of the room panel. The LCD display illuminates with a brightness level stored in the BACKGROUND\_ILLUMINATION\_LCD\_FOR\_ACTIVE\_MODE register. By default, the value of illumination for the active mode is 60%. It means that the display illuminates with 60% of the maximum possible brightness. The LCD display stays in the Active mode for as long as it is determined in the BACKGROUND\_ILLUMINATION\_LCD\_TIME\_TO\_IDLE register. The register contains time value in seconds (by default 10 sec) and the time countdown starts with an activation of the Active mode. It means that pressing any of the keypad buttons resets the timer and countdown starts again.
- Idle: the mode becomes active always after the Active mode (Time to Idle is up). The display illuminates with a brightness level stored in the BACKGROUND\_ILLUMINATION\_LCD\_FOR\_IDLE\_MODE register (by default 40%). The display stays in the Idle mode during the time stored in the BACKGROUND\_ILLUMINATION\_LCD\_TIME\_TO\_STANDBY register (by default 5 sec).
- Standby: the mode becomes active always after the Idle mode (Time to Standby is up). The display illuminates with a brightness level stored in the BACKGROUND\_ILLUMINATION\_LCD\_FOR\_STANDBY\_MODE register (by default 0%). The display stays in the Standby mode for as long as the Active mode is not initiated.



The actual LCD display brightness level value is stored in the BACKGROUND\_ILLUMINATION\_LCD\_CURRENT\_VALUE register.

## 5.8 Keypad

There are four push buttons in the panel. All together create the 4-button keypad which can be illuminated to help locate it in dark places. The keypad makes it possible for the user to control the room panel locally. Control buttons are designed to navigate between different menus as well as to change, select, and display values of particular parameters. All push buttons are located below the LCD display, and each of them has a different functionality. Functions dedicated for each button are described in separate sections.

Pushing any button enters the room panel into the active mode (in case the room panel remains in modes other than active, and it is powered). If the beeper is active, pushing any button emits the beeper sound.

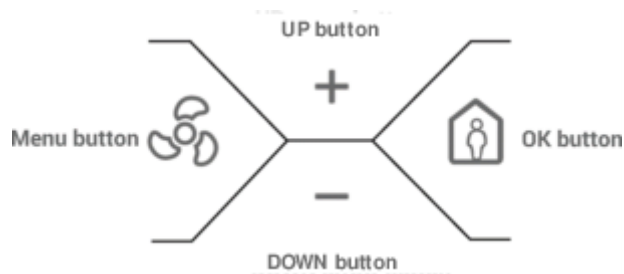

Figure 15. Keypad buttons

### 5.8.1 Menu Button

If the device is in active mode, pressing the Menu button opens the Fan menu. The Menu button allows to exit particular menus and parameters' edit mode. The button cancels selection of new values of parameters (when the parameter stays in edit mode and the FastEditMode is not active).

### 5.8.2 OK Button

If the device is in active mode, pressing the OK button opens the Occupancy menu. When the device is in menu edit mode, pressing the button opens different menus and confirms newly chosen parameters values during edition.

### 5.8.3 Up and Down Buttons

If the device is in active mode, pressing the up or down button increases or decreases the setpoint or the offset value.

In the menu edit mode, up and down buttons switch between submenus and change values of particular parameters during edition.

### 5.8.4 Keypad Background Illumination Settings

If one of four keypad buttons is pressed, the room panel changes state into the active mode. The same happens if the power supply is reconnected or after the room panel restart. In case when there is no keypad activity and the room panel stays on, the subsequent background illumination modes activate. The keypad illuminates only when

the value of the DEVICE\_CONFIGURATION register bit 4 is true. If not, the keypad is never illuminated.

Particular modes activate sequentially one after another according to the following sequence:

- Active: the mode activates after pressing any keypad button or after the room panel restart. The keypad illuminates with a brightness level stored in the BACKGROUND\_ILLUMINATION\_KEY\_PAD\_FOR\_ACTIVE\_MODE. By default, the value of illumination for the active mode is 10%. It means that the LCD display illuminates with 10% of the maximum possible brightness. The keypad stays in the active mode for as long as it is determined in the BACKGROUND\_ILLUMINATION\_KEY\_PAD\_TIME\_TO\_IDLE register. The register contains time value in seconds (by default 10 sec) and a time countdown starts when the active mode becomes active. In practice it means that pressing any of the keypad buttons resets a timer and countdown starts again.
- Idle: the mode becomes active always after the active mode (time to idle is up). The keypad illuminates with a brightness stored in the BACKGROUND\_ILLUMINATION\_KEY\_PAD\_FOR\_IDLE\_MODE register (by default 40%). The keypad stays in the idle mode during the time value stored in the BACKGROUND\_ILLUMINATION\_KEY\_PAD\_TIME\_TO\_STANDBY register (by default 5 sec).
- Standby: the mode becomes active always after the idle mode (time to standby is up). The keypad illuminates with a brightness level stored in the BACKGROUND\_ILLUMINATION\_KEY\_PAD\_FOR\_STANDBY\_MODE register (by default 60%). The keypad stays in the standby mode for as long as the active mode is not initiated.

The actual keypad display brightness level value is stored in the BACKGROUND\_ILLUMINATION\_KEY\_PAD\_CURRENT\_VALUE register.

## 6 Sensors

Actual sensor values are displayed on the 8-segment display block in the LCD display, at the same time. There are 3 different sensors which can be built-in in the room panel (depending on the room panel version):

- Temperature sensor;
- Humidity sensor;
- CO<sub>2</sub> sensor.

Actual values from all in-built sensors can be displayed in the main menu in a specific order (see section [LCD Display](#)).

The 14-segment display block shows the name of the parameter actual value of which is displayed on the 8-segment display block. Every numeric value is displayed with an assigned unit.

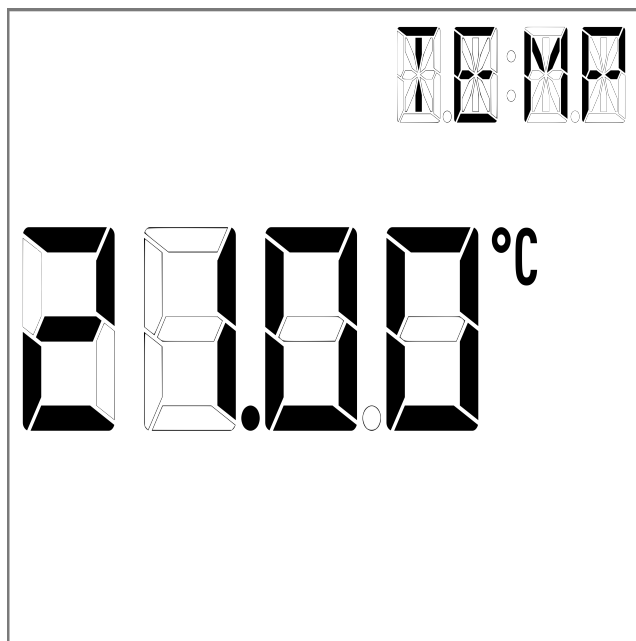

Figure 16. Display with unit

### 6.1 Temperature Sensor

All room panel versions have a built-in temperature sensor. The default temperature unit is °C, and it is displayed together with a temperature sensor value (if active).

#### 6.1.1 TEMPERATURE\_SENSOR\_ACTUAL\_VALUE (30301)

The register stores actual values from the temperature sensor (including Temperature Sensor Offset) multiplied by 10. In the main menu the temperature sensor value is displayed directly (without multiplying). Actual register value is calculated according to the equation:

Actual temperature (register value) = (Actual sensor temperature + Temperature sensor offset)\*10

## TEMPERATURE\_SENSOR\_OFFSET (40304)

The register contains a value which allows for setting a correction of the temperature sensor's actual value indication. The offset value can be positive or negative. The register value is also multiplied by 10 as in case of the temperature sensor actual value register. The actual temperature offset value is added to temperature sensor indication. The default value is 0.

## TEMPERATURE\_FILTER (40307)

The register contains a time constant for a temperature sensor low pass filter. The value is expressed in seconds. The default filter value is 60 seconds. Setting the register's value to 0 disables the filter.

## TEMPERATURE\_NAME (40310)

The 32-bit register contains up to 4 characters (ASCII code), which can be displayed as a text (name) on the 14-segment display block, together with the TEMPERATURE\_SENSOR\_ACTUAL\_VALUE register (displayed on the 8-segment display block). In case if a particular character's value is 0 (NULL), the character is not displayed. Lower case characters are automatically changed into upper case characters. The default value is 1297110085 which corresponds to the name "TEMP".

For example:

Task: Display text " TMP" (empty space in the first position).

Solution: Register contains two bytes. Each of them contains two characters encoded with the ASCII code.

In this example, the lower byte needs to have NULL + "T" character and the higher byte "M" + "P" characters.

Low byte: "NULL" in ASCII = 0

"T" in ASCII code = 54

Final value which needs to be written down to low byte = 84

High byte: "M" in ASCII code = 4D

"P" in ASCII code = 50

Final value which needs to be written down to high byte = 19792

32-bit register has a structure = 0x4D500054

The value which has to be written to register = 1297088596

## TEMPERATURE\_CONFIGURATION (40316, Bit 0 and Bit 4)

Bit	Name	0	1
0	Active	Not active	Active(def)
4	ThirdPointActive	No decimal	Decimal(def)

Table 17. Temperature configuration

The bit 0 of the register 40316 is responsible for activation or deactivation of the visibility of temperature sensor. If the bit 0 is active, the temperature sensor actual value is visible in the main menu.

The bit 4 of the register 40316 is responsible for the temperature display precision. True value of the bit 4 activates temperature displaying precision to the first decimal place. If the bit 4 is false, the temperature is displayed as an integer value (without decimal place).

## 6.2 Humidity Sensor

The default humidity unit is RH%, and it is displayed together with a humidity sensor value (if active) permanently (not editable).

**WARNING!** All registers described below are active only if the room panel is equipped with a built-in humidity sensor.

### 6.2.1 HUMIDITY\_SENSOR\_ACTUAL\_VALUE (30302)

The register stores actual value from the humidity sensor (including Humidity Sensor Offset value) multiplied by 10. In the main menu, the humidity sensor value is displayed directly (without multiplying).

### HUMIDITY\_SENSOR\_OFFSET (40305)

The register contains a value which allows for setting a correction of the humidity sensor actual value indication. The offset value can be positive or negative. The register value is also multiplied by 10 as in case of the HUMIDITY\_SENSOR\_ACTUAL\_VALUE register. The actual humidity offset value is added to the humidity sensor indication. The default value is 0.

### HUMIDITY\_FILTER (40308)

The register contains a time constant for the humidity sensor low pass filter. The value is expressed in seconds. The default filter value is 60 seconds. Setting the 0 value disables the filter.

### HUMIDITY\_NAME (40312)

The 32-bit register contains up to 4 characters (ASCII code), which can be displayed as a text (name) on the 14-segment display block, together with the HUMIDITY\_SENSOR\_ACTUAL\_VALUE register (displayed on the 8-segment display block). In case if a particular character value is 0 (NULL), the character is not displayed. Lower case characters are automatically changed into upper case characters. The default value is 1296648277, which corresponds to the text "HUMI".

### HUMIDITY\_CONFIGURATION (40317, Bit 0 and Bit 4)

Bit	Name	0	1
0	Active	Not active	Active(def)

Bit	Name	0	1
4	ThirdPointActive	No decimal	Decimal(def)

Table 18. Humidity configuration

The bit 0 of the register 40317 is responsible for activation or deactivation of the visibility of the humidity sensor. If the bit 0 is active, the actual value of the humidity sensor is visible in the main menu.

The bit 4 of the register 40316 is responsible for the humidity display precision. True value of the bit 4 activates a precision of humidity display to the first decimal place. If the bit 4 is false, humidity is displayed as an integer value (without decimal place).

## 6.3 CO<sub>2</sub> Sensor

The default CO<sub>2</sub> unit is ppm, and it is displayed together with the CO<sub>2</sub> sensor value (if active) permanently (not editable). The CO<sub>2</sub> actual sensor value is displayed in delay of 120 sec after the room panel restart or power supply connection (if the bit 0 of the CO<sub>2</sub> configuration is true). The CO<sub>2</sub> sensor needs up to 2 minutes to warm up from the moment of power supply connection. The CO<sub>2</sub> sensor achieves maximum accuracy after 10 minutes of operation. It is worth mentioning that the built-in CO<sub>2</sub> sensor does not need a manual calibration. Calibration algorithm begins after 24 hours of continuous operation, adjusting the sensor measurement.

**WARNING!** All registers described below are active only if the room panel is equipped with a built-in CO<sub>2</sub> sensor.

### 6.3.1 CO<sub>2</sub>\_SENSOR\_ACTUAL\_VALUE (30303)

The 30303 register stores an actual value from the CO<sub>2</sub> sensor (including CO<sub>2</sub> Sensor Offset).

### CO<sub>2</sub>\_SENSOR\_OFFSET (40306)

The register contains a value which allows for setting a correction of the CO<sub>2</sub> sensor actual value indication. The offset value can be positive or negative. The actual CO<sub>2</sub> offset value is added to the CO<sub>2</sub> sensor indication. The default offset is 0.

### CO<sub>2</sub>\_FILTER (40309)

The register contains a time constant for the CO<sub>2</sub> sensor low pass filter. The value is expressed in seconds. The default filter value is 60 seconds. Setting the 0 value disables the filter.

### CO<sub>2</sub>\_NAME (40314)

The 32-bit register contains up to 4 characters (ASCII code), which can be displayed as a text (name) on the 14-segment display block together with the CO<sub>2</sub>\_SENSOR\_ACTUAL\_VALUE register (displayed on the 8-segment display block). In case

when a particular character value is 0 (NULL), the character is not displayed. Lower case characters are automatically changed into upper case characters. The default value is 838878031, which corresponds to the text "CO<sub>2</sub>".

### CO<sub>2</sub>\_CONFIGURATION (40318, Bit 0)

The bit 0 of the register 40318 is responsible for activation or deactivation of the visibility of the CO<sub>2</sub> sensor. If the bit 0 is active, the CO<sub>2</sub> sensor's actual value is visible in the main menu. The default value is true (visible).

**WARNING!** The CO<sub>2</sub> value is visible with delay of 120 sec after the room panel restart or power supply connection.

### CO<sub>2</sub>\_SETPOINT\_FOR\_ALARM (40226)

The register contains a setpoint for the alarm value in ppm. If the actual CO<sub>2</sub> sensor value increases over the setpoint value, then the room panel indicates the CO<sub>2</sub> alarm (for other indication possibilities see the [Device Configuration](#) section). The default value is 1500 ppm.

### CO<sub>2</sub>\_DIFFERENTIAL\_FOR\_ALARM (40227)

The register contains a value in ppm which is the differential for the CO<sub>2</sub> alarm value. The CO<sub>2</sub> alarm is activated if the CO<sub>2</sub> actual sensor value is higher or equal to the sum of the CO<sub>2</sub>\_SETPOINT\_FOR\_ALARM register value and the CO<sub>2</sub> differential for the alarm value. The CO<sub>2</sub> alarm is inactive if the CO<sub>2</sub> actual sensor value is lower or equal to the difference of the CO<sub>2</sub>\_SETPOINT\_FOR\_ALARM register value and the CO<sub>2</sub> differential for the alarm value. The default value is 100 ppm.

CO<sub>2</sub> Alarm ON:

CO<sub>2</sub> sensor actual value  $\geq$  CO<sub>2</sub> SetpointforAlarm + CO<sub>2</sub> differential for alarm

CO<sub>2</sub> Alarm OFF:

CO<sub>2</sub> sensor actual value  $\leq$  CO<sub>2</sub> SetpointforAlarm - CO<sub>2</sub> differential for alarm

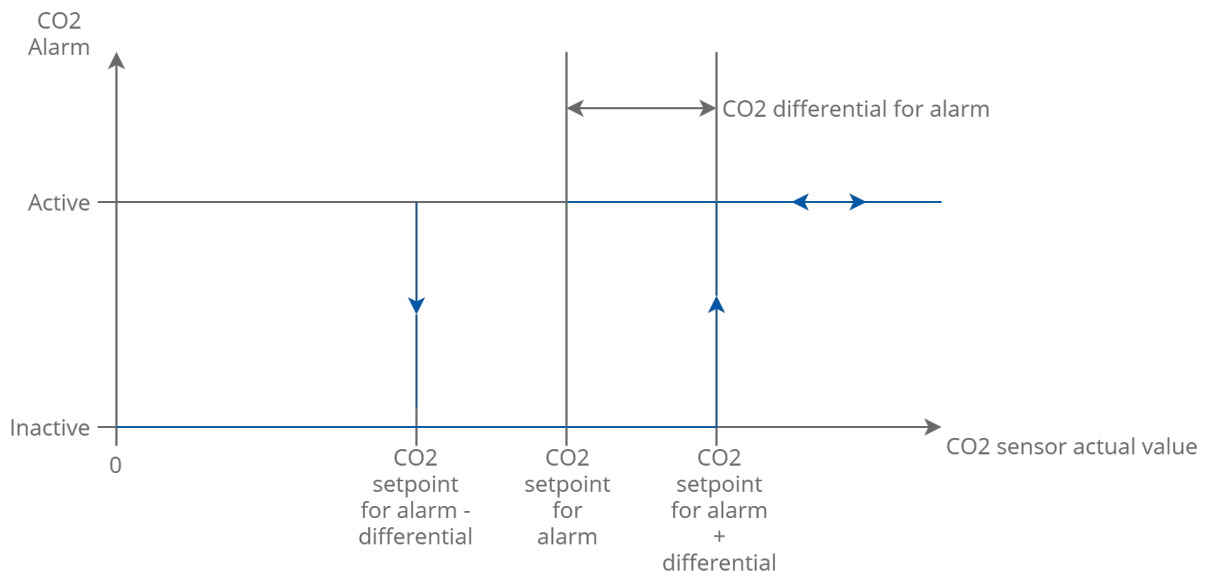

Figure 17. CO2 alarm with differential for active alarm



## 7 Setpoints

This section outlines the registers for setpoints configuration.

### 7.1 SETPOINT\_VALUE (41501)

The register stores an actual setpoint value multiplied by 10. After device restart, the value is read from the DEFAULT\_SETPOINT\_VALUE register and set as the actual setpoint value. The default value is 210.

### 7.2 EFFECTIVE\_SETPOINT (31502)

The register represents a sum of the actual setpoint value and offset setpoint value. This value is a final setpoint value.

### 7.3 DEFAULT\_SETPOINT (41503)

The register contains a default setpoint value. The default setpoint is set as a setpoint value after the room panel restart or power supply reconnection (the value of the DEFAULT\_VALUE register is written down to the SETPOINT\_VALUE register). The register contains value multiplied by 10. The default value is 210.

### 7.4 OFFSET\_SETPOINT (41504)

The register contains a value which allows for setting a correction for the setpoint value. The offset value can be positive or negative. The offset setpoint value is added to the setpoint value and the result value is entered to the EFFECTIVE\_SETPOINT register. The register contains value multiplied by 10. The default value is 0.

### 7.5 SETPOINT\_LOW\_LIMIT (41505)

The register contains a minimum setpoint value, which can be set by the user, multiplied by 10. The default value is 180 (18°C).

### 7.6 SETPOINT\_HIGH\_LIMIT (41506)

The register contains a maximum setpoint value, which can be set by the user, multiplied by 10. The default value is 240 (24°C).

### 7.7 OFFSET\_RANGE (41507)

The register contains a value, which limits the offset setpoint value change, multiplied by 10. The value creates a range from – OffsetRange to + OffsetRange of possible offset values, which can be set by the user. The default value is 30 (3°C).

For example:

Offset range value is 20. It means that the user can change the offset setpoint value from -2°C to +2°C.

## 7.8 SETPOINT\_STEP (41508)

The register contains a setpoint step value multiplied by 10. If the setpoint is changed by arrow buttons locally from the room panel, pressing of the arrow button causes a setpoint change with the step value stored in this register. The setpoint can be changed in the range determined by setpoint limits stored in the SETPOINT\_LOW\_LIMIT and SETPOINT\_HIGH\_LIMIT registers.

The setpoint step is also automatically adjusted to the setpoint display precision. If the register SETPOINT\_CONFIGURATION bit 4 is true, the setpoint value is displayed with one decimal place. In that case the setpoint step is also adjusted to one decimal place.

For example:

The SETPOINT\_CONFIGURATION register bit 4 is true, and the SETPOINT\_STEP value equals 5. The actual setpoint step will be automatically adjusted to one decimal place, so the SETPOINT\_STEP value will be scaled to 0.5.

The function is active only if the SETPOINT\_CONFIGURATION bit 4 is true. Otherwise, the setpoint value is displayed as an integer value and the SETPOINT\_STEP register adjustment is unnecessary. The default value is 10 (1°C).

## 7.9 OFFSET\_NAME (41509)

The 32-bit register contains up to 4 characters (ASCII code), which can be displayed as a text (name) on the 14-segment display block together with the OFFSET\_VALUE register (displayed on the 8-segment display block). In case if a particular character value is 0 (NULL), the character is not displayed. Lower case characters are automatically changed into upper case characters. The default value is 1179864902, which corresponds to the name "OFFS".

## 7.10 SETPOINT\_NAME (41511)

The 32-bit register contains up to 4 characters (ASCII code), which can be displayed as a text (name) on the 14-segment display block together with the SETPOINT\_VALUE register (displayed on 8-segment display block). In case if a particular character value is 0 (NULL), the character is not displayed. Lower case characters are automatically changed into upper case characters. The default value is 1414550341 which corresponds to the name "SETP".

## 7.11 Configuration

### 7.11.1 SETPOINT CONFIGURATION (41513)

#### SETPOINT\_VISIBILITY (41513, Bit 0)

The bit 0 is responsible for activation or deactivation of the setpoint visibility. If the bit 0 is active, the setpoint actual value is displayed in the main menu with the defined display priority (see the [Main Menu Display](#)). By default, the bit 0 is true (setpoint is visible).

### SETPOINT\_EDITION (41513, Bit 1)

The bit 1 determines a possibility to change the setpoint locally from the room panel. If the bit is true, the setpoint is editable, and the user can change the setpoint value by pressing up/down arrow buttons. If the bit is false, pressing arrow buttons sets the room panel in the active mode and has no effect on the setpoint value. By default, the bit 1 is true (setpoint is editable).

### OPERATING\_MODE (41513, Bit 2)

The bit 2 value determines a setpoint mode edition. If the bit 2 is true, the up and down arrow buttons change the setpoint value. If the bit 2 is false, pressing up/down arrow buttons changes the setpoint offset (the change is limited to the OFFSET\_RANGE register value). By default, the bit 2 is true (changing setpoint).

### SETPOINT\_DISPLAY (41513, Bit 3)

The bit 3 function is effective only if the bit 2 OPERATING\_MODE is false (changing offset). The bit 3 allows for choosing which value is displayed during the offset edition.

If the bit is true, the EFFECTIVE\_SETPOINT value and the SETPOINT\_NAME are shown on the display during offset changing.

If the bit is false, the LCD display shows the OFFSET\_SETPOINT value and the OFFSET\_NAME value. By default, the bit 3 is false.

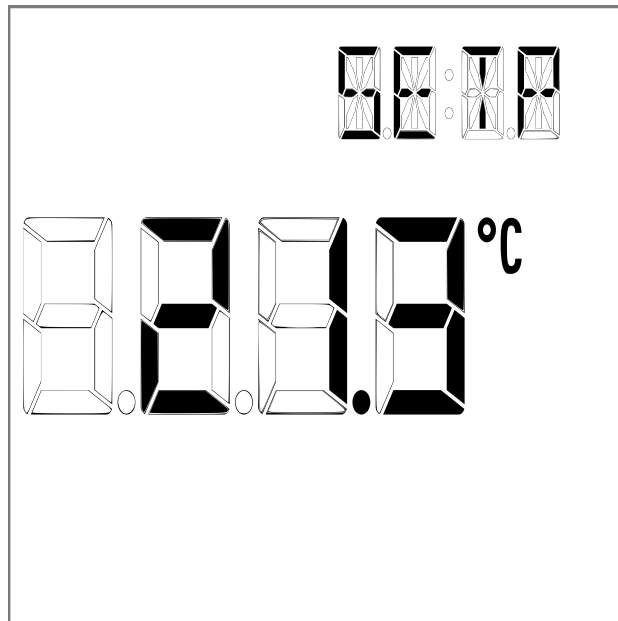

Figure 18. Setpoint with decimals

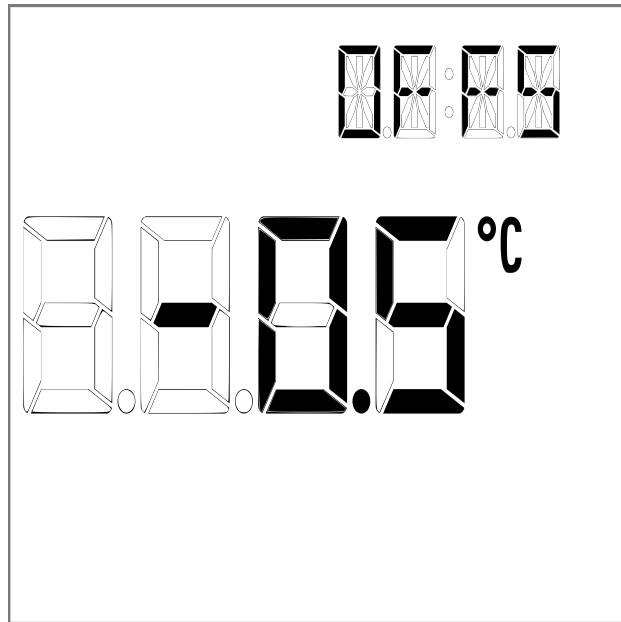

Figure 19. Offset with decimals



Figure 20. Setpoint without decimals

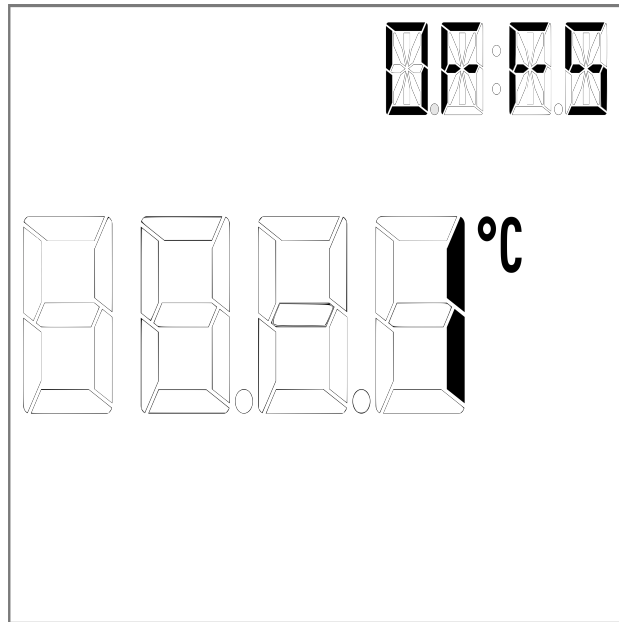

Figure 21. Offset without decimals

### THIRD\_POINT\_ACTIVE (41513, Bit 4)

The bit 4 true value activates the setpoint display precision to the first decimal place. If the bit 4 is false, the setpoint is displayed as an integer value (without decimal place). The default value is true.

### SETPOINT\_FAST\_EDIT\_MODE (41513, Bit 5)

The bit 5 switches between setpoint normal edit and setpoint fast edit modes. By default, the bit 5 value is 0 (normal edit mode).

#### Setpoint Normal Edit mode

If the bit 5 is false, the normal edit mode is active. The setpoint can be changed by the arrow buttons. The newly chosen setpoint has to be confirmed by pressing the OK button.

Confirmation of entering the new setpoint is signaled by double blink of the new setpoint and double beeper signal (if enabled in the DEVICE\_CONFIGURATION register, bit 0).

If the setpoint change is complete, the main menu is displayed.

Pressing the Menu button, before confirming the new setpoint, cancels the new setpoint setting procedure, and the user returns to the main menu.

If the new setpoint is not confirmed during time value stored in the EXIT\_EDIT\_TIME register, setting this new setpoint has failed, and the main menu is displayed.

#### Setpoint Fast Edit mode

If the bit 5 is true, the fast edit mode is active, and setting the new setpoint does not need a confirmation. The new setpoint is selected by pressing the OK button. Pressing any other button confirms the setpoint choice. The same situation is when time value in the EXIT\_EDIT\_TIME register elapsed. The newly chosen setpoint is confirmed.

Confirmation of the new setpoint is signaled by double blink of the new setpoint name and double beeper signal (if enabled in the DEVICE\_CONFIGURATION register, bit 0).

Once the setpoint selection procedure is complete, the main menu is displayed.

## 7.12 Setting

Setting setpoints is possible from the main menu level.

If the room panel is in the active mode or in the idle mode, pressing the one of arrow buttons leads to the setpoint edit mode.

### 7.12.1 OPERATING\_MODE (41513)

#### OPERATING\_MODE (41513, Bit 2): True

If the setpoint is in the edit mode, its value, unit, and name flash with a frequency calculated according to the value stored in the SUBMENU\_ICON\_FLASHING\_TIME register.

Pressing the up arrow button increases the setpoint value with the step value stored in the SETPOINT\_STEP register.

If the entered value is higher than the value stored in the SETPOINT\_HIGH\_LIMIT register, the actual setpoint value is overwritten by the value in that register.

Pressing the down arrow button decreases the setpoint value with the step value stored in the SETPOINT\_STEP register.

If the entered value is lower than the value stored in the SETPOINT\_LOW\_LIMIT register, the actual setpoint value is overwritten by the value in that register.

#### OPERATING\_MODE (41513, Bit 2): False

In case if the OPERATING\_MODE (41513, Bit 2) register value is false, the user changes the setpoint value indirectly, by changing the SETPOINT\_OFFSET register value.

If the SETPOINT\_DISPLAY (41513, Bit 3) value is false, then OFFSET\_SETPOINT register value is displayed.

If the offset is in the edit mode, its value, unit, and name flash with a frequency calculated according to the value stored in the SUBMENU\_ICON\_FLASHING\_TIME register.

Pressing the up arrow button increases the OFFSET\_SETPOINT register value with the step value stored in the SETPOINT\_STEP register.

If the entered value is higher than the value stored in the OFFSET\_RANGE register, the actual OFFSET\_SETPOINT value is overwritten by the value in that register.

Pressing the down arrow button decreases OFFSET\_SETPOINT register with the step value stored in the SETPOINT\_STEP register.

If the entered value is lower than the negative value of the OFFSET\_RANGE register, the actual OFFSET\_SETPOINT value is overwritten by the value in that register.

If the SETPOINT\_DISPLAY (41513, Bit 3) value is true, the procedure is similar but instead of displaying THE OFFSET\_SETPOINT and OFFSET\_NAME values on the LCD display, the EFFECTIVE\_SETPOINT with SETPOINT\_NAME values are displayed.

## 8 Fan

The room panel allows fan control with the actual fan status indication. There is a special group of icons responsible for fan status indication. The fan configuration registers allow to select different fan control modes, corresponding to different fan types. According to the actual fan status, different icon combinations are displayed. It allows to quickly preview and service the fan status.

The user can switch different fan modes locally in a very simple way. The FAN\_MODE REGISTER and manual speed setting are available from the main menu level. If the room panel is in the active mode, pressing a Menu button enters the fan submenu edition. The text FAN flashes on the 14-segment displays' block, and the name of the FAN\_MODE register is displayed on the 8-segment displays' block, according to which fan mode is already active (see the FAN\_MODE\_NAME table).

### 8.1 FAN\_CURRENT\_SPEED (41601)

The register stores numeric values corresponding to the current fan speed. Each register value displays a specified icon (see the table below). The register value can be used as an actual fan status indication. This register has a software limitation, where the max. value is 6.







Register Value	Visualization
0(def)	
1	
2	
3	
4	
5	
6	

Table 19. Fan speed icons

### 8.2 FAN\_MODE (41602)

The register contains numeric values corresponding to the fan mode. There are up to 5 different fan modes, which can be selected locally from the fan edit submenu level. To enter the fan edit submenu, press the Menu button, when the room panel is in the active mode. Particular fan modes availability depends on the FAN\_TYPE register value. Default texts for particular fan modes can be edited in the FAN\_MODE\_NAME register. This register has a software limitation, where the max. value is 4.



Fan Mode Text on LCD	Register Value
OFF	0
I	1(def)
II	2
III	3
AUTO	4

Table 20. FAN\_MODE register values

### 8.3 FAN\_TYPE (41603)

The register contains numeric values corresponding to the fan type. The fan type selection determines which fan modes are available in the FAN\_MODE register. This register has a software limitation, where the max. value is 6. Available fan modes in particular fan type selection are shown in the table below:

Register Value	Fan Type	Comment	Available Fan Mode Texts on LCD
0	0-10 V (def)	Fan is controlled by the analog value 0-10 V DC	OFF I II III Auto
1	1-Speed	1-Speed Fan	OFF I Auto
2	2-Speed	2-Speed Fan	OFF I II Auto
3	3-Speed	3-Speed Fan	OFF I II III Auto
4	1-Speed	1-Speed Fan without AUTO mode	OFF I
5	2-Speed	2-Speed Fan without AUTO mode	OFF I II

Register Value	Fan Type	Comment	Available Fan Mode Texts on LCD
6	3-Speed	3-Speed Fan without AUTO mode	OFF I II III

Table 21. FAN\_TYPE values

**WARNING!** The register values from 4 to 6 (1-3 speed fan without AUTO mode) have to be set when fan works in Local Mode (see [Fan Local Mode](#)).

## 8.4 FAN\_MODE\_NAME (41604-41612)

These six 32-bit registers are assigned with six different fan modes, which can contain up to 4 characters according to the ASCII code. The value of the 32-bit register is displayed on the 8-segment display block as a text. In case if a particular ASCII code value is 0(NULL), the character is not displayed. Lower case characters are automatically changed into upper case characters. For user-friendly use, the FAN\_MODE register value is displayed on LCD as a text instead of a numeric value.

Register Address	Default Name	Corresponding FAN_MODE Register Value
41604	OFF	0
41606	AUTO	1
41608	I	2
41610	II	3
41612	III	4

Table 22. The FAN\_MODE\_NAME register values

## 8.5 Configuration

### 8.5.1 FAN\_CONFIGURATION (41614)

#### FAN\_CURRENT\_SPEED\_VISIBILITY (41614, Bit 0)

The bit 0 is responsible for activation or deactivation of fan current speed visibility. If the bit 0 is active, the fan current speed is visible as a group of icons. The icons indicate fan activity (run status), actual speed, and auto/manual mode.

Run indication (symbol rotates when a fan is running)



Auto/manual mode indication (Hand symbol when manual mode is active)

Actual speed symbol

Table 23. The FAN\_CURRENT\_SPEED\_VISIBILITY icon

The default value is 1 (fan current speed is visible).

### FAN\_EDITION (41614, Bit 1)

The bit 1 determines if the FAN\_MODE is editable locally from the room panel. If the bit 1 is true, the fan edit submenu is active, and the user can set the FAN\_MODE. If the bit 1 is false, the fan edit submenu is inactive. The default value is 1 (FAN\_MODE is editable).

### PART\_EDITABLE (41614, Bit 2)

The bit 2 switches between the fan full edition and fan part edition modes.

Bit 2 Value	Function
0	Fan Full Edition (def)
1	Fan Part Edition

Table 24. The PART\_EDITABLE Bit 2 values

#### Fan Full Edition Mode

In the fan full edition mode, all modes stored in the FAN\_MODE register are available from the fan edit submenu level.

#### Fan Part Edition Mode

In the fan part edition mode, the user can switch only between the auto and off FAN\_MODE register values from the fan edit submenu level; all other fan modes are unavailable.

### FAN\_CONFIG\_FAST\_EDIT\_MODE (41614, Bit 5)

The bit 5 switches between the fan normal edit and fan fast edit modes. By default, the bit 5 is false (normal edit mode).

#### Fan Normal Edit Mode

If the bit 5 is false, the normal edit mode is active. Fan modes are selected by the arrow buttons. The chosen fan mode has to be confirmed by pressing the OK button. The new fan mode confirmation is signaled by a double blink of the new FAN\_MODE name, its assigned symbol, and a double beeper signal (if enabled, DeviceConfiguration bit 0).

Once the fan mode selection is completed, the main menu is displayed.

Pressing the Menu button, before confirming the new fan mode with the OK button, cancels the new FAN\_MODE register setting procedure, and the user gets back to the main menu.

If the new FAN\_MODE register setting is not confirmed during a time value stored in the EXIT\_EDIT\_TIME register, the new FAN\_MODE register selection is failed and the main menu is displayed.

**Fan Fast Edit Mode**





If the bit 5 is true, the fast edit mode is active, and setting the new FAN\_MODE register value does not need any confirmation. The new fan mode is selected by pressing the Menu button. Pressing any other button confirms the new fan mode choice. The same happens when the time value, set in the EXIT\_EDIT\_TIME register, elapsed—the chosen fan mode is confirmed. The new fan mode confirmation is signaled by a double blink of the new FAN\_MODE name, its assigned symbol, and a double beeper signal (if enabled, DEVICE\_CONFIGURATION bit 0).  
Once the fan mode selection is completed, the main menu is displayed.

**FAN\_CONFIG\_LOCAL\_MODE (41614, Bit 6)**

The bit 6 switches between the local mode and the BMS modes, which define how the FAN\_CURRENT\_SPEED register value is determined. By default, the bit 6 is false (BMS mode).

**Local Mode**

If the bit 6 is true, the room panel fan setting works in a local mode. It means that the value of the FAN\_CURRENT\_SPEED register is determined by the value of the FAN\_MODE register and so the value of the FAN\_CURRENT\_SPEED register cannot be overwritten by the higher level system.

FAN_MODE Register Value	FAN_CURRENT_SPEED Register Value	Visualization
0	0	
1(def)	1	
2	2	
3	3	

**BMS Mode**

If the bit 6 is false, the room panel fan setting works in the BMS mode. The FAN\_MODE register works separately from the FAN\_CURRENT\_STATUS register.

**8.5.2 FAN\_ICON\_FLASHING\_TIME (41615)**

The register contains a time value in milliseconds, which is the base for calculating a frequency of flashing run indication icons (setting a rotation speed of the run indication symbol). This register has a software limitation, where the minimum time value is 50 ms. By default, the time value is set to 500 ms (fan run indication icons change repeatedly with 2 Hz frequency).

## 9 Occupancy

Setting of the occupancy mode is available from the main menu level. If the room panel is in the active mode, pressing the OK button leads the user to the occupancy edit submenu. The text "OCCM" flashes on the 14-segment display block (with frequency calculated on the basis of the SUBMENU\_ICON\_FLASHING\_TIME register value), and the name of the current OCCUPANCY\_MODE register value is displayed on the 8-segment display block.

### 9.1 OCCUPANCY\_CURRENT\_STATUS (41701)

The register contains a numeric value corresponding to the actual occupancy status. The particular register value determines displaying a specific group of icons (see the table below). This register has a software limitation, where the maximum value is 3. The register value can be used as the actual occupancy status indication.





Register Value	Icon
0	
1	
2	
3	 Human symbol blinks

Table 25. The OCCUPANCY\_CURRENT\_STATUS register icons

### 9.2 OCCUPANCY\_MODE (41702)

The register contains a numeric value corresponding to the occupancy mode. There are two different occupancy modes, which can be selected locally from the occupancy edit submenu level (see the table below). To enter the occupancy edit submenu, press the OK button, when the room panel is in the active mode. This register has a software limitation, where the maximum value is 1. The default texts for particular occupancy modes can be changed (see [Occupancy Mode Name](#)).

Occupancy Mode Text on LDC	Register Value
UNOC	0
OCC	1

Table 26. The OCCUPANCY\_MODE register values

### 9.3 OCCUPANCY\_MODE\_NAME (41703, 41705)

The two 32-bit registers are assigned with two different occupancy modes, which contain up to 4 characters according to the ASCII code (see example in the TEMPERATURE\_NAME

register). The value of the 32-bit register is displayed on the 8-segment display block as text. In case if a particular ASCII code value is 0 (NULL), the character is not displayed. Lower case characters are automatically changed into upper case characters. For more user-friendly use, the OCCUPANCY\_MODE register value is displayed on LCD as text instead of numeric value.

Register Address	Default Name	Corresponding OCCUPANCY_MODE Register Value
41703	UNOC	0
41705	OCC	1

Table 27. The OCCUPANCY\_MODE\_NAME register values

scds

## 9.4 Configuration

### 9.4.1 OCCUPANCY\_CONFIGURATION (41707)

#### OCCUPANCY\_VISIBILITY (41707, Bit 0)

The bit 0 of the register 41707 is responsible for activation or deactivation of the occupancy current status visibility. If the bit 0 is active, the occupancy current status is visible as a specific group of icons.

In the occupied mode, the human symbol stays inside the house symbol (if forced, occupied mode human symbol blinks inside the house).



In the unoccupied mode, the human symbol stays outside of the house symbol.

Table 28. The OCCUPANCY\_VISIBILITY register icons

The default value is 1 (occupancy mode is visible).

#### OCCUPANCY\_MODE\_EDITION (41707, Bit 1)

The bit 1 of the register 41707 determines, whether the OCCUPANCY\_MODE register is editable locally from the room panel. If the bit 1 is true, the occupancy edit submenu is active and the user can set the occupancy mode. If the bit 1 is false, the occupancy edit submenu is inactive. The default value is 1 (occupancy mode is editable).

#### EDIT\_MODE (41707, Bit 5)

The bit 5 of the register 41707 switches between the occupancy normal edit and the occupancy fast edit modes. By default, the bit is 0 (normal edit mode).

##### Occupancy Normal Edit Mode

If the bit 5 is false, the normal edit mode is active. Particular occupancy modes are selected by arrow buttons. The chosen occupancy mode has to be confirmed by pressing the OK button. The new occupancy mode is signaled by a double blink of the new occupancy mode name, an assigned symbol (see [the OCCUPANCY\\_MODE register](#)), and a double beeper signal (if enabled, DeviceConfiguration bit 0). If the

occupancy mode selection is completed, the main menu is displayed. Pressing the Menu button, prior to confirming the new occupancy mode with the OK button, cancels the new occupancy mode setting procedure, and the user returns to the main menu. If the new occupancy mode is not confirmed during the time value stored in the EXIT\_EDIT\_TIME register, the new occupancy mode selection fails, and the main menu is displayed.

### Occupancy Fast Edit Mode



If the bit 5 is true, the fast edit mode is active, and setting the new occupancy mode does not need any confirmation. The new occupancy mode is selected by pressing the OK button. Pressing any other button confirms the new occupancy mode choice. The same happens if the time value in the EXIT\_EDIT\_TIME register elapsed. The chosen occupancy mode is confirmed. The new occupancy mode is signaled by a double blink of the new occupancy mode name, an assigned symbol (see [the OCCUPANCY\\_MODE register](#)), and a double beeper signal (if enabled, DeviceConfiguration bit 0). Once the occupancy mode selection procedure is completed, the main menu is displayed.

## OCCUPIED\_CONFIG\_LOCAL\_MODE (41707, Bit 6)

The bit 6 of register 41707 switches between the local and BMS modes. By default, the bit 6 is false (BMS mode).

### Local Mode

If the bit 6 is true, the room panel occupancy setting works in a local mode. It means that the value of the OCCUPANCY\_CURRENT\_STATUS register is determined by the value of the OCCUPANCY\_MODE register, and the value of the OCCUPANCY\_CURRENT\_STATUS register cannot be overwritten by the higher level system.

OCCUPANCY_MODE Register Value	OCCUPANCY_CURRENT_STATUS Register Value	Visualization
0	0	
1	1	

### BMS Mode

If bit 6 is false, the room panel occupancy setting works in a BMS mode. The OCCUPANCY\_MODE register works independently from the OCCUPANCY\_CURRENT\_STATUS register.

## 10 Registers Adjustable Locally from the Room Panel

### 10.1 Room Panel Settings

Accessing the settings from the main menu level is possible in the active mode.

In order to enter the settings locally, press the OK button and the Menu button together, for the time longer than the time value stored in the ENTER\_MENU\_TIME register. Access to the settings menu is protected by a password stored in the PANEL\_PASSWORD register (default password: 1000).

The settings menu name blinks on the 14-segment display block.

Particular settings are selected by pressing the up and down arrow buttons.

Press the OK button to enter a selected setting.

Upon entering a particular setting, the parameters are displayed in ascending order (by a parameter number) on the 14-segment display block.

Available parameters are selected by pressing the up or down arrow buttons.

All parameters are described in detail in further sections of this User Manual.

#### 10.1.1 Configuration (CONF)

The configuration menu contains registers responsible for the device configuration. Most of the registers available in the configuration menu are the communication registers: baud rate, Modbus address, stop bits, parity bits and protocol selection. The user can also change the panel's password and check the firmware version in the configuration menu. All available parameters are presented in the table below:

Parameter Number	Modbus Address	Decimal Address	Hex Address	Register Name	Access	Description
1.1	40017	16	0x10	BAUD_RATE	Read/write	48-1152 (*100kbs)
1.2	40023	22	0x16	ADDRESS	Read/write	Default: 1
1.3	40018	17	0x11	STOP_BITS	Read/write	1: one stop bit 2: two stop bits
1.4	40020	19	0x13	PARITY_BITS	Read/write	0: disabled 1: odd 2: even
1.5	40024	23	0x17	PROTOCOL	Read/write	0: Modbus RTU 1: Modbus ASCII 2: BACnet MS/TP
1.6	40028	27	0x1B	PANEL_PASSWO RD	Read/write	Default: 1000



Parameter Number	Modbus Address	Decimal Address	Hex Address	Register Name	Access	Description
1.7	-	-	-	FIRMWARE_VERSION	Read-only	Software Version

Table 29. The CONF menu settings

### 10.1.2 Device (DEV)

The Device settings menu contains registers responsible for global settings. Changing any of parameter in the Device menu impacts modes and functions of the room panel. The Device menu contains parameters for time settings, such as time format, menu enter or exit time, or refresh time. In the Device menu, the user can also switch the beeper off or disable the background illumination of the LCD display or keypad. All available parameters are presented in the table below:

Parameter Number	Modbus Address	Decimal Address	Hex Address	Register Name	Access	Description
2.1	40205	204	0xCC	DEVICE CONFIGURATION bit 0 BEEPER	Read/write	0: inactive 1: active(def)
2.2	40205	204	0xCC	DEVICE CONFIGURATION bit 1 TIME_FORMAT	Read/write	0-24h(def) 1-12h
2.3	40205	204	0xCC	DEVICE CONFIGURATION bit 2 TEMPERATURE_UNIT	Read/write	Not supported
2.4	40205	204	0xCC	DEVICE CONFIGURATION bit 3 BACKGROUND_ILLUMINATION_LCD_ACTIVE	Read/write	0: inactive 1: active(def)
2.5	40205	204	0xDE	DEVICE CONFIGURATION bit 4 BACKGROUND_ILLUMINATION_KEYPAD_ACTIVE	Read/write	0: inactive(def) 1: active
2.6	40223	222	0x1B	ENTER_MENU_TIME	Read/write	Default: 2 sec
2.7	40224	223	0xDF	EXIT_EDIT_TIME	Read/write	Default: 5 sec
2.8	40225	224	0xE0	EXIT_MENU_TIME	Read/write	Default: 10 sec
2.9	40217	216	0xD8	REFRESH_TIME	Read/write	Default: 2 sec

Table 30. The DEV menu settings

### 10.1.3 Temperature (TEMP)

The Temperature settings menu contains registers referring to the temperature sensor display and temperature control settings. The user is able to switch on/off the temperature sensor value display, set the temperature sensor filter, or change the temperature sensor offset. All available parameters are presented in the table below:

Parameter Number	Modbus Address	Decimal Address	Hex Address	Register Name	Access	Description
3.1	40316	315	0x13B	TEMPERATURE_CONFIGURATION bit 0 ACTIVE	Read/write	0: inactive 1-active(def)
3.2	40316	315	0x13B	TEMPERATURE_CONFIGURATION bit 4 THIRD_POINT_ACTIVE	Read/write	0: inactive 1: active(def)
3.3	40307	306	0x132	TEMPERATURE_FILTER	Read/write	Default: 60 sec
3.4	40304	303	0x12F	TEMPERATURE_OFFSET	Read/write	Default: 0

Table 31. The TEMP menu settings

### 10.1.4 Humidity (HUM)

The Humidity settings menu contains registers referring to the humidity sensor display and the humidity control settings. The user is able to switch on/off the humidity sensor value display, set the humidity sensor filter, or change the humidity sensor offset. All available parameters are presented in the table below:

Parameter Number	Modbus Address	Decimal Address	Hex Address	Register Name	Access	Description
4.1	40317	316	0x13C	HUMIDITY_CONFIGURATION bit 0 ACTIVE	Read/write	0: inactive 1: active(def)
4.2	40317	316	0x13C	HUMIDITY_CONFIGURATION bit 4 THIRD_POINT_ACTIVE	Read/write	0: inactive 1: active(def)
4.3	40308	307	0x133	HUMIDITY_FILTER	Read/write	Default: 60 sec
4.4	40305	304	0x130	HUMIDITY_OFFSET	Read/write	Default: 0

Table 32. The HUM menu settings

### 10.1.5 CO2 (CO2)

The CO<sub>2</sub> settings menu contains registers referring to the CO<sub>2</sub> sensor display and CO<sub>2</sub> control settings. The user is able to switch on/off the CO<sub>2</sub> sensor value display, set the CO<sub>2</sub> sensor filter, or change the CO<sub>2</sub> sensor offset. All available parameters are presented in the table below:

Parameter Number	Modbus Address	Decimal Address	Hex Address	Register Name	Access	Description
5.1	40318	317	0x13D	CO2 CONFIGURATION bit 0 ACTIVE	Read/write	0: inactive 1: active(def)
5.2	40309	308	0x134	CO2_FILTER	Read/write	Default: 60 sec
5.3	40307	306	0x132	CO2_OFFSET	Read/write	Default: 0
5.4	40226	225	0xE1	CO2_SETPOINT	Read/write	Default: 1500 ppm

Table 33. The CO2 menu settings

### 10.1.6 Setpoint (SETP)

In the Setpoint settings menu, the user has access to the main setpoint registers. It is possible to change most useful setpoint parameters locally from the room panel, such as a default setpoint, low and high setpoint limits, setpoint step, or offset range. The user can also decide if the setpoint value should be displayed in the main menu, or if the setpoint or offset should be changed during a setpoint edition. All available parameters are presented in the table below:

Parameter Number	Modbus Address	Decimal Address	Hex Address	Register Name	Access	Description
6.1	41513	1512	0x5E8	SETPOINT_CONFIG URATION bit 0 ACTIVE	Read/write	0-inactive 1-active(def)
6.2	41513	1512	0x5E8	SETPOINT_CONFIG URATION bit 1 EDITABLE	Read/write	0-inactive 1-active(def)
6.3	41513	1512	0x5E8	SETPOINT_CONFIG URATION bit 2 OPERATING_MODE	Read/write	0-changing offset 1-changing setpoint(def)
6.4	41513	1512	0x5E8	SETPOINT_CONFIG URATION bit 3 SETPOINT_DISPLAY	Read/write	0-changing offset 1-changing effective setpoint(def)

Parameter Number	Modbus Address	Decimal Address	Hex Address	Register Name	Access	Description
6.5	41513	1512	0x5E8	SETPOINT_CONFIGURATION bit 4 THIRD_POINT_ACTIVE	Read/write	0-inactive 1-active(def)
6.6	41513	1512	0x5E8	SETPOINT_CONFIGURATION bit 5 FAST_EDIT_MODE	Read/write	0-inactive(def) 1-active
6.7	41503	1502	0x5DE	DEFAULT_SETPOINT	Read/write	By default 210
6.8	41505	1504	0x5E0	SETPOINT_LOW_LIMIT	Read/write	By default 180
6.9	41506	1505	0x5E1	SETPOINT_HIGH_LIMIT	Read/write	By default 240
6.10	41507	1506	0x5E2	OFFSET_RANGE	Read/write	By default 30
6.11	41508	1507	0x5E3	SETPOINT_STEP	Read/write	By default 10

Table 34. The SETP menu settings

### 10.1.7 Fan (FAN)

The Fan settings menu contains the registers of fan configuration settings. The user can change the fan type or decide if the fan status is displayed in the main menu. Editable parameters determine if the user can change particular fan modes. All available parameters are presented in the table below:

Parameter Number	Modbus Address	Decimal Address	Hex Address	Register Name	Access	Description
7.1	41614	1613	0x64D	FAN_CONFIGURATION bit 0 VISIBLE_FAN_CURRENT_SPEED	Read/write	0: inactive 1: active(def)
7.2	41614	1613	0x64D	FAN_CONFIGURATION bit 1 EDITABLE	Read/write	0: inactive 1: active(def)
7.3	41614	1613	0x64D	FAN_CONFIGURATION bit 2 PART_EDITABLE	Read/write	0: inactive(def) 1: active
7.4	41614	1613	0x64D	FAN_CONFIGURATION bit 5 FAST_EDIT_MODE	Read/write	0: inactive(def) 1: active

Parameter Number	Modbus Address	Decimal Address	Hex Address	Register Name	Access	Description
7.5	41615	1614	0x64E	FAN_ICON_FLASHING_TIME	Read/write	Default: 500 ms
7.6	41603	1602	0x642	FAN_TYPE	Read/write	0: 0-10 V(def) 1: 1-Speed 2: 2-Speed 3: 3-Speed

Table 35. The FAN menu settings

### 10.1.8 Occupancy (OCCU)

The Occupancy settings menu contains registers referring to the occupancy configuration. The user can decide if the current occupancy status is displayed in the main menu. Editable parameters determine if the user can change the occupancy mode. All available parameters are presented in the table below:

Parameter Number	Modbus Address	Decimal Address	Hex Address	Register Name	Access	Description
8.1	41707	1706	0x6AA	OCCUPANCY_CONFIGURATION bit 0 VISIBLE_OCCUPANCY_CURRENT_STATUS	Read/write	0: inactive 1: active(def)
8.2	41707	1706	0x6AA	OCCUPANCY_CONFIGURATION bit 1 EDITABLE	Read/write	0: inactive 1: active(def)
8.3	41707	1706	0x6AA	OCCUPANCY_CONFIGURATION bit 5 FAST_EDIT_MODE	Read/write	0: inactive(def) 1: active

Table 36. The OCCU menu settings

## 11 Main Menu User-defined Parameters

There are 8 numeric and 8 Boolean user-defined parameters available in the main menu. All of them are read-only locally in the room panel (read/write type available in the higher level system), and they are written to the EEPROM memory (register values are remembered after the room panel restart or power failure).

Each parameter has to be activated to be visible. Active parameters are displayed in the main menu in a specified sequence.

After a room panel restart, user-defined parameters are not displayed until they are overwritten from a higher level system (programmable controller).

The main menu user-defined parameters are implemented for displaying additional information.

## 12 Submenu User-defined Parameters

The room panel contains a special group of registers, which allow to define parameters by the user.

User-defined parameters are grouped into 6 submenus:

- Temperature submenu;
- Fan submenu;
- Light submenu;
- Blind submenu;
- Alarm submenu;
- Occupancy submenu.

Each submenu is automatically activated if one of the parameters, assigned to that submenu, is active. If the particular submenu is active, then the icon of that submenu is displayed in the main menu. The Fan and Occupancy submenu icons are displayed in different configuration according to the actual fan and occupancy status.

In each submenu, there are available 8 numeric and 8 Boolean user-defined parameters.

All user-defined parameters are used for displaying and setting different values locally from the room panel. All are written to the EEPROM memory (register values are remembered after the room panel restart or power failure).

Access to each submenu can be protected by a password.

### 12.1 Numeric Parameters Registers

Each submenu has 8 numeric user-defined parameters. Each of the user-defined parameters has the same structure: it contains 7 registers dedicated to different functionalities and purposes. Each register is described below. (The exact Modbus address for each register is available in the [List of Modbus Registers](#)).

#### 12.1.1 XPresentValue (X = [1.8])

The register contains an actual value of the parameter. The default value is 0.

#### 12.1.2 XName (X = [1.8])

The 32-bit register contains up to 4 characters (ASCII code), which can be displayed as a text (name) on the 14-segment display block together with the XPresentValue register (displayed on the 8-segment display block). In case if a particular character value is 0 (NULL), the character is not displayed. Lower case characters are automatically changed into upper case characters. The default name is NUMX, where X=[1.8] (e.g., the register value for the name "NUM1" = 1295076949).

#### 12.1.3 XPriority (X = [1.8])

The register contains a value determining the parameter's priority. The parameter's priority determines a sequence of parameters displayed inside the particular submenu. The parameter with the highest priority is displayed as a first parameter in the submenu. The parameter with the lowest priority is displayed as a last parameter in the submenu. If two or more parameters have the same priority, the sequence of displaying is based on

register addresses (the register with the lowest address is displayed as first). The default priority for all user-defined parameters is 0.

#### **12.1.4 XStep (X = [1.8])**

The register contains a value, which is a step value during the parameter value edition. The default value is 0.

#### **12.1.5 XLowLimit (X = [1.8])**

The register contains a minimum value of the parameter (the minimum value, which can be set locally from the room panel). The default value is 0.

#### **12.1.6 XHighLimit (X = [1.8])**

The register contains a maximum value of the parameter (the maximum value, which can be set locally from the room panel). The default value is 0.

#### **12.1.7 XConfiguration (X = [1.8])**

##### **Visibility Bit 0**

The bit 0 activates a parameter's visibility. If the bit 0 is active, the parameter actual value is displayed in the particular submenu with the defined display priority. By default, the bit 0 value is false (the parameter is inactive).

##### **Editable Bit 1**

The bit 1 activates an edition of the parameter value locally from the room panel. If the bit 1 is true, the parameter is editable, and the user can change its value. By default, the bit 1 is false. (the parameter is not editable).

##### **First Point Active Bit 2**

The bit 2 activates a parameter display precision to the first decimal place. The default value is false.

##### **Second Point Active Bit 3**

The bit 3 activates a parameter display precision to the second decimal place. The default value is false.

##### **Third Point Active Bit 4**

The bit 4 activates a parameter display precision to the third decimal place. The default value is false.

##### **°C Unit Active Bit 6**

If the bit 6 is true, the actual parameter present value is displayed along with the °C unit. The default value is 0.



### **°F Unit Active Bit 7**

If the bit 7 is true, the actual parameter present value is displayed along with the °F unit. The default value is 0.

### **Pa Unit Active Bit 8**

If the bit 8 is true, the actual parameter present value is displayed along with the Pa unit. The default value is 0.

### **Lx Unit Active Bit 9**

If the bit 9 is true, the actual parameter present value is displayed along with the Lx unit. The default value is 0.

### **ppm Unit Active Bit 10**

If the bit 10 is true, the actual parameter present value is displayed along with the ppm unit. The default value is 0.

### **m3h Unit Active Bit 11**

If the bit 11 is true, the actual parameter present value is displayed along with the m3h unit. The default value is 0.

### **%Rh Unit Active Bit 12**

If the bit 12 is true, the actual parameter present value is displayed along with the %Rh unit. The default value is 0.

### **Ls Unit Active Bit 13**

If the bit 13 is true, the actual parameter present value is displayed along with the Ls unit. The default value is 0.

### **% Unit Active Bit 14**

If the bit 14 is true, the actual parameter present value is displayed along with the % unit. The default value is 0.

### **h Unit Active Bit 15**

If the bit 15 is true, the actual parameter present value is displayed along with the h unit. The default value is 0.

## **12.2 Boolean Parameters Registers**

Each submenu has 8 Boolean user-defined parameters. Each of the user-defined parameters has the same structure: it contains 6 registers dedicated to different functionalities and purposes. Each register is described below. (The exact Modbus address for each register is available in the [List of Modbus Registers](#)).

### 12.2.1 XPresentValue (X = [1.8])

The register contains an actual value of the parameter. The default value is 0 (inactive).

#### Worth to notice

Please note that the register is an integer type. To use the Boolean type point refer to Submenu Boolean All Present Value Registers.

### 12.2.2 XName (X = [1.8])

The 32-bit register contains up to 4 characters (ASCII code), which can be displayed as a text (name) on the 14-segment display block together with the XPresentValue register value (displayed on the 8-segment display block). In case if a particular character value is 0 (NULL), the character is not displayed. Lower case characters are automatically changed into upper case characters. The default name is BOOX, where X=[1.8] (e.g., the register value for name "BOO1" = 1328628303).

### 12.2.3 XTrueText (X = [1.8])

For a more user-friendly experience, the XPresentValue register value is displayed on the LCD as a text instead of a numeric value. The 32-bit XTrueText register, associated with the active state of the XPresentValue register, contains up to 4 characters according to the ASCII code (see example in [Temperature Name](#)). The value of the 32-bit register is displayed on the 8-segment display block as a text. In case if a particular ASCII code value is 0 (NULL), the character is not displayed. Lower case characters are automatically changed into upper case characters. The default name is "ON" (the register value = 20302).

### 12.2.4 XFalseText (X = [1.8])

For user-friendly use, the XPresentValue register value is displayed on the LCD as a text instead of a numeric value. The 32-bit XTrueText register, associated with the inactive state of the XPresentValue register, contains up to 4 characters according to the ASCII code (see example in [Temperature Name](#)). The value of the 32-bit register is displayed on the 8-segment display block as a text. In case if a particular ASCII code value is 0 (NULL), the character is not displayed. Lower case characters are automatically changed into upper case characters. The default name is "OFF" (the register value = 1174425414).

### 12.2.5 XPriority (X = [1.8])

The register contains a value determining the parameter's priority. The parameter's priority determines a sequence of parameters displayed inside the particular submenu. The parameter with the highest priority is displayed as a first parameter in the submenu. The parameter with the lowest priority is displayed as a last parameter in the submenu. If two or more parameters have the same priority, the sequence of displaying is based on register addresses (the register with the lowest address is displayed as first). The default priority for all user-defined parameters is 0.

## 12.2.6 XConfiguration (X = [1.8])

### Visibility Bit 0

The bit 0 activates a parameter's visibility. If the bit 0 is active, the parameter actual value is displayed in the particular submenu with the defined display priority. By default, the bit 0 value is false (the parameter is inactive).

### Editable Bit 1

The bit 1 activates an edition of the parameter value locally from the room panel. If the bit 1 is true, the parameter is editable, and the user can change its value. By default, the bit 1 is false. (the parameter is not editable).

## 12.3 MenuActivePoints Registers

For each submenu there is a special register, which indicates if there are any active parameters inside the particular submenu. If the value of the MenuActivePoints register is higher than 0, it means that there is at least one active parameter in the submenu, and the icon assigned to that submenu is displayed.

The MenuActivePoints register reads values from all XConfiguration active bits inside a particular submenu. If one of the active bit values is true, the MenuActivePointsregister becomes positive.

## 12.4 Boolean PresentValue Registers (40107-40113)

For each submenu there is a special register, which contains all Boolean PresentValues inside a particular submenu. Setting a true value for a single bit, sets a true value for the assigned Boolean Point, according to the table below. By default, all bits of the register are false.

Bit	Name	0	1
0	Boolean1PresentValue	Not active(def)	Active
1	Boolean2PresentValue	Not active(def)	Active
...	...	...	...
...	...	...	...
6	Boolean7PresentValue	Not active(def)	Active
7	Boolean8PresentValue	Not active(def)	Active

Table 37. Boolean PresentValue registers

### 13 List of Modbus Registers

The table below shows all registers available for the room panel.

Modbus Address	Decimal Address	Hex Address	Register Name	Access	Description								
40001	0	0x00	VERSION_TYPE	Read/write	First byte indicates a version, and another one indicates a type of a device. Allows to enable 1 of 4 device actions.								
30004	3	0x03	RECEIVED_FRAMES COUNTER (32-bits)	Read-only	The default state is 0. Reset at the unit start and change of transmission parameters.								
30006	5	0x05	ERROR_FRAMES COUNTER (32-bits)	Read-only	The default state is 0. Reset at the unit start and change of transmission parameters.								
30008	7	0x07	TRANSMITTED_FRAME COUNTER_(32-bits)	Read-only	The default state is 0. Reset at the unit start and change of transmission parameters.								
30012	12	0x0C	LIVE_TIME (32-bits)	Read-only	Device uptime in sec								
40015	14	0x0E	BACNET_DEVICE_ID (32-bits)	Read/write Memory	Default 0xFFFFFFFF								
40017	16	0x10	BAUD_RATE	Read/write Memory	Transmission speed is defined by the user, calculated using the formula:  The default value is 11520 (115200 bps).								
40018	17	0x11	STOP_BITS	Read/write Memory	Supported values are 1 and 2. The default value is 1.								
40020	19	0x13	PARITY_BIT	Read/write Memory	The default value is 0 (no parity). Allowed values: <table border="1" data-bbox="1018 1646 1428 1915"> <thead> <tr> <th>Value</th> <th>Description</th> </tr> </thead> <tbody> <tr> <td>0 (default)</td> <td>None</td> </tr> <tr> <td>1</td> <td>Odd</td> </tr> <tr> <td>2</td> <td>Even</td> </tr> </tbody> </table>	Value	Description	0 (default)	None	1	Odd	2	Even
Value	Description												
0 (default)	None												
1	Odd												
2	Even												
40021	20	0x14	REPLAY_DELAY	Read/write Memory	Delay in ms before sending response. The default value is 0.								

Modbus Address	Decimal Address	Hex Address	Register Name	Access	Description																								
40023	22	0x16	ADDRESS	Read/write Memory	Modbus address of the device. The default value is 1.																								
40024	23	0x17	PROTOCOL	Read/write Memory	0: Modbus RTU (default) 1: Modbus ASCII 2: BACnet MS/TP																								
40028	27	0x1B	PANEL_PASSWORD	Read/write Memory	Password for Menu Edit Mode. The default is 1000.																								
30029	28	0x1C	SENSORS	Read-only	BIT0: humidity sensor BIT1: CO2 sensor BIT2: NTC sensor																								
30201	200	0xC8	BACKGROUND_ILLUMINATION LCD_CURRENT_VALUE	Read-only	Actual display illumination value																								
30202	201	0xC9	BACKGROUND_ILLUMINATION KEY_PAD_CURRENT_VALUE	Read-only	Actual keypad illumination value																								
40203	202	0xCA	HOURS	Read/write	Hours part in time display																								
40204	203	0xCB	MINUTES	Read/write	Minutes part in time display																								
40205	204	0xCC	DEVICE_CONFIGURATION	Read/write Memory	<table border="1"> <thead> <tr> <th>Bit</th> <th>Name</th> <th>0</th> <th>1</th> </tr> </thead> <tbody> <tr> <td>0</td> <td>Beeper</td> <td>Not active</td> <td>Active(def)</td> </tr> <tr> <td>1</td> <td>Format</td> <td>24h(def)</td> <td>12h</td> </tr> <tr> <td>3</td> <td>Illumination LCD</td> <td>Not active</td> <td>Active(def)</td> </tr> <tr> <td>4</td> <td>Illumination Keypad</td> <td>Not active(def)</td> <td>Active</td> </tr> <tr> <td>5</td> <td>CO2Alarm LCD</td> <td>Not active</td> <td>Active</td> </tr> </tbody> </table>	Bit	Name	0	1	0	Beeper	Not active	Active(def)	1	Format	24h(def)	12h	3	Illumination LCD	Not active	Active(def)	4	Illumination Keypad	Not active(def)	Active	5	CO2Alarm LCD	Not active	Active
Bit	Name	0	1																										
0	Beeper	Not active	Active(def)																										
1	Format	24h(def)	12h																										
3	Illumination LCD	Not active	Active(def)																										
4	Illumination Keypad	Not active(def)	Active																										
5	CO2Alarm LCD	Not active	Active																										

Modbus Address	Decimal Address	Hex Address	Register Name	Access	Description																												
					<table border="1"> <tr> <td>6</td> <td>CO2Alarm Buzzer</td> <td>Not active</td> <td>Active</td> </tr> <tr> <td>7</td> <td>CO2Alarm HIGH</td> <td>Not active</td> <td>Active</td> </tr> <tr> <td>10</td> <td>Submenu IconDisplayOFF</td> <td>Not active</td> <td>Active</td> </tr> <tr> <td>11</td> <td>Panel OFF</td> <td>Panel ON(def)</td> <td>Panel OFF</td> </tr> <tr> <td>12</td> <td>Keypad OFF</td> <td>Key Pad ON(def)</td> <td>Key Pad OFF</td> </tr> <tr> <td>13</td> <td>Flashing LCD</td> <td>Not active(def)</td> <td>Active</td> </tr> <tr> <td>14</td> <td>Flashing Keypad</td> <td>Not active(def)</td> <td>Active</td> </tr> </table>	6	CO2Alarm Buzzer	Not active	Active	7	CO2Alarm HIGH	Not active	Active	10	Submenu IconDisplayOFF	Not active	Active	11	Panel OFF	Panel ON(def)	Panel OFF	12	Keypad OFF	Key Pad ON(def)	Key Pad OFF	13	Flashing LCD	Not active(def)	Active	14	Flashing Keypad	Not active(def)	Active
6	CO2Alarm Buzzer	Not active	Active																														
7	CO2Alarm HIGH	Not active	Active																														
10	Submenu IconDisplayOFF	Not active	Active																														
11	Panel OFF	Panel ON(def)	Panel OFF																														
12	Keypad OFF	Key Pad ON(def)	Key Pad OFF																														
13	Flashing LCD	Not active(def)	Active																														
14	Flashing Keypad	Not active(def)	Active																														
40207	206	0xCE	BACKGROUND_ILLUMINATION LCD_FOR_ACTIVE_MODE	Read/write Memory	Default 60%																												
40208	207	0xCF	BACKGROUND_ILLUMINATION LCD_FOR_IDLE_MODE	Read/write Memory	Default 40%																												
40209	208	0xD0	BACKGROUND_ILLUMINATION LCD_FOR_STANDBY_MODE	Read/write Memory	Default 0%																												
40210	209	0xD1	BACKGROUND_ILLUMINATION LCD_TIME_TO_IDLE	Read/write Memory	Default 10 sec																												
40211	210	0xD2	BACKGROUND_ILLUMINATION LCD_TIME_TO_STANDBY	Read/write Memory	Default 5 sec																												
40212	211	0xD3	BACKGROUND_ILLUMINATION KEY_PAD_ACTIVE_MODE	Read/write Memory	Default 10%																												

Modbus Address	Decimal Address	Hex Address	Register Name	Access	Description																																	
40213	212	0xD4	BACKGROUND_ILLUMINATION KEY_PAD_IDLE_MODE	Read/ write Memory	Default 40%																																	
40214	213	0xD5	BACKGROUND_ILLUMINATION KEY_PAD_STANDBY_MODE	Read/ write Memory	Default 60%																																	
40215	214	0xD6	BACKGROUND_ILLUMINATION_KEY PAD_TIME_TO_IDLE	Read/ write Memory	Default 10 sec																																	
40216	215	0xD7	BACKGROUND_ILLUMINATION KEY_PAD_TIME_TO_STANDBY	Read/ write Memory	Default 5 sec																																	
40217	216	0xD8	REFRESH_TIME	Read/ write Memory	Default 2 sec																																	
40218	217	0xD9	TIME_CONFIGURATION	Read/ write Memory	Bit 0: 1 clock is visible (default) Bit 0: 0 clock is not visible																																	
40219	218	0xDA	LCD_ICON_DISPLAY	Read/ write Memory	Each bit of the register shows or hides assigned icon, as in the table below: <table border="1" data-bbox="1018 1303 1426 2042"> <thead> <tr> <th>Bit</th> <th>Icon Name</th> <th>Icon</th> </tr> </thead> <tbody> <tr> <td>0</td> <td>Sun</td> <td></td> </tr> <tr> <td>1</td> <td>Moon</td> <td></td> </tr> <tr> <td>2</td> <td>Heating</td> <td></td> </tr> <tr> <td>3</td> <td>Cooling</td> <td></td> </tr> <tr> <td>4</td> <td>Humidfire</td> <td></td> </tr> <tr> <td>5</td> <td>Dehumidfire</td> <td></td> </tr> <tr> <td>6</td> <td>Wireless</td> <td></td> </tr> <tr> <td>7</td> <td>Settings</td> <td></td> </tr> <tr> <td>8</td> <td>Eco</td> <td></td> </tr> <tr> <td>9</td> <td>Recirculation</td> <td></td> </tr> </tbody> </table>	Bit	Icon Name	Icon	0	Sun		1	Moon		2	Heating		3	Cooling		4	Humidfire		5	Dehumidfire		6	Wireless		7	Settings		8	Eco		9	Recirculation	
Bit	Icon Name	Icon																																				
0	Sun																																					
1	Moon																																					
2	Heating																																					
3	Cooling																																					
4	Humidfire																																					
5	Dehumidfire																																					
6	Wireless																																					
7	Settings																																					
8	Eco																																					
9	Recirculation																																					

Modbus Address	Decimal Address	Hex Address	Register Name	Access	Description
					10   PC
40220	219	0xDB	LCD_ICON_DISPLAY	Read/ write Memory	Each bit of the register starts flashing of the assigned Icon. See table in LCD ICON DISPLAY register description.
40221	220	0xDC	LCD_ICON_FLASHING_TIME	Read/ write Memory	The time value, which is the base for calculating frequency of icon flashing. Icons are visible for 100% of the time value stored in the register, and hidden for 20% of that time. Default time: 500ms.
40222	221	0xDD	SUBMENU_ICON_FLASHING_TIME	Read/ write Memory	The time value, which is the base for calculating frequency of icon flashing. Icons are visible for 100% of the time value stored in the register, and hidden for 20% of that time. Default time 1000ms.
40223	222	0xDE	ENTER_MENU_TIME	Read/ write Memory	Default 2 sec
40224	223	0xDF	EXIT_EDIT_TIME	Read/ write Memory	Default 5 sec
40225	224	0xE0	EXIT_MENU_TIME	Read/ write Memory	Default 10 sec
40226	225	0xE1	CO2_SETPOINT_FOR_ALARM	Read/ write Memory	CO2 alarm setpoint. By default 1500 ppm.
40227	226	0xE2	CO2_HYSTERESIS_FOR_ALARM	Read/ write Memory	CO2 alarm hysteresis. By default 100 ppm.
30230	229	0xE5	ALARM_STATUS	Read-only	CO2 current alarm status
30301	300	0x12C	TEMPERATURE_SENSOR	Read-only	Actual temperature sensor value with offset.



Modbus Address	Decimal Address	Hex Address	Register Name	Access	Description												
30302	301	0x12D	HUMIDITY_SENSOR	Read-only	Actual humidity sensor value with offset.												
30303	302	0x12E	CO2_SENSOR	Read-only	Actual CO2 sensor value with offset.												
40304	303	0x12F	TEMPERATURE_SENSOR_OFFSET	Read/write Memory	Temperature sensor offset. The default is 0.												
40305	304	0x130	HUMIDITY_SENSOR_OFFSET	Read/write Memory	Humidity sensor offset. The default is 0.												
40306	305	0x131	CO2_SENSOR_OFFSET	Read/write Memory	CO2 sensor offset. The default is 0.												
40307	306	0x132	TEMPERATURE_FILTER	Read/write Memory	Default 60 sec												
40308	307	0x133	HUMIDITY_FILTER	Read/write Memory	Default 60 sec												
40309	308	0x134	CO2_FILTER	Read/write Memory	Default 60 sec												
40310	309	0x135	TEMPERATURE_NAME (32-bits)	Read/write Memory	Displayed temperature sensor name: TEMP.												
40312	311	0x137	HUMIDITY_NAME (32-bits)	Read/write Memory	Displayed humidity sensor name: HUMI.												
40314	313	0x139	CO2_NAME (32-bits)	Read/write Memory	Displayed CO2 sensor name: CO2.												
40316	315	0x13B	TEMPERATURE_CONFIGURATION	Read/write Memory	<table border="1"> <thead> <tr> <th>Bit</th> <th>Name</th> <th>0</th> <th>1</th> </tr> </thead> <tbody> <tr> <td>0</td> <td>Active</td> <td>Not active</td> <td>Active(def)</td> </tr> <tr> <td>4</td> <td>ThirdPointActive</td> <td>No decimal</td> <td>Decimal(def)</td> </tr> </tbody> </table>	Bit	Name	0	1	0	Active	Not active	Active(def)	4	ThirdPointActive	No decimal	Decimal(def)
Bit	Name	0	1														
0	Active	Not active	Active(def)														
4	ThirdPointActive	No decimal	Decimal(def)														

Modbus Address	Decimal Address	Hex Address	Register Name	Access	Description												
40317	316	0x13C	HUMIDITY_CONFIGURATION	Read/write Memory	<table border="1"> <tr> <td>Bit</td> <td>Name</td> <td>0</td> <td>1</td> </tr> <tr> <td>0</td> <td>Active</td> <td>Not active</td> <td>Active(def)</td> </tr> <tr> <td>4</td> <td>ThirdPointActive</td> <td>No decimal</td> <td>Decimal (def)</td> </tr> </table>	Bit	Name	0	1	0	Active	Not active	Active(def)	4	ThirdPointActive	No decimal	Decimal (def)
Bit	Name	0	1														
0	Active	Not active	Active(def)														
4	ThirdPointActive	No decimal	Decimal (def)														
40318	317	0x13D	CO2_CONFIGURATION	Read/write Memory	<table border="1"> <tr> <td>Bit</td> <td>Name</td> <td>0</td> <td>1</td> </tr> <tr> <td>0</td> <td>Active</td> <td>Not active</td> <td>Active(def)</td> </tr> </table>	Bit	Name	0	1	0	Active	Not active	Active(def)				
Bit	Name	0	1														
0	Active	Not active	Active(def)														
41501	1500	0x5DC	SETPOINT_VALUE	Read/write	Actual setpoint value. After reset, the default value is set to the setpoint value.												
41502	1501	0x5DD	EFFECTIVE_SETPOINT	Read-only	Sum of Effective Setpoint and Offset value.												
41503	1502	0x5DE	DEFAULT_SETPOINT	Read/write Memory	Default 21°C												
41504	1503	0x5DF	OFFSET_SETPOINT	Read/write Memory	Default 0°C												
41505	1504	0x5E0	SETPOINT_LOW_LIMIT	Read/write Memory	Min. available setpoint value. By default 18°C.												
41506	1505	0x5E1	SETPOINT_HIGH_LIMIT	Read/write Memory	Max. available setpoint value. By default 24°C.												
41507	1506	0x5E2	OFFSET_RANGE	Read/write Memory	Limit offset value. By default 3°C.												
41508	1507	0x5E3	SETPOINT_STEP	Read/write Memory	Setpoint value step. By default 1°C.												
41509	1508	0x5E4	OFFSET_NAME (32-bits)	Read/write Memory	Displayed offset name: OFFS.												

Modbus Address	Decimal Address	Hex Address	Register Name	Access	Description																												
41511	1510	0x5E6	SETPOINT_NAME (32-bits)	Read/ write Memory	Displayed setpoint name: SETP.																												
41513	1512	0x5E8	SETPOINT_CONFIGURAT ION	Read/ write Memory	<table border="1"> <thead> <tr> <th>B it</th> <th>Name</th> <th>0</th> <th>1</th> </tr> </thead> <tbody> <tr> <td>0</td> <td>Visible</td> <td>Not visible</td> <td>Visible(de f)</td> </tr> <tr> <td>1</td> <td>Editabl e</td> <td>Not Editable</td> <td>Editable(def)</td> </tr> <tr> <td>2</td> <td>Opper ating Mode</td> <td>Changi ng Offset</td> <td>Changing Setpoint(def)</td> </tr> <tr> <td>3</td> <td>Setpoi nt Display</td> <td>Show/ change Offset</td> <td>Show/ change EffectiveS etpoint</td> </tr> <tr> <td>4</td> <td>ThirdP ointAct ive</td> <td>Not active</td> <td>Active(def )</td> </tr> <tr> <td>5</td> <td>FastEdi tMode</td> <td>Not active(d ef)</td> <td>Active</td> </tr> </tbody> </table>	B it	Name	0	1	0	Visible	Not visible	Visible(de f)	1	Editabl e	Not Editable	Editable(def)	2	Opper ating Mode	Changi ng Offset	Changing Setpoint(def)	3	Setpoi nt Display	Show/ change Offset	Show/ change EffectiveS etpoint	4	ThirdP ointAct ive	Not active	Active(def )	5	FastEdi tMode	Not active(d ef)	Active
B it	Name	0	1																														
0	Visible	Not visible	Visible(de f)																														
1	Editabl e	Not Editable	Editable(def)																														
2	Opper ating Mode	Changi ng Offset	Changing Setpoint(def)																														
3	Setpoi nt Display	Show/ change Offset	Show/ change EffectiveS etpoint																														
4	ThirdP ointAct ive	Not active	Active(def )																														
5	FastEdi tMode	Not active(d ef)	Active																														
41601	1600	0x640	FAN_MODE	Read/ write	<table border="1"> <thead> <tr> <th>Register value</th> <th>Fan Mode</th> <th>Visualiza tion</th> </tr> </thead> <tbody> <tr> <td>0</td> <td>OFF</td> <td></td> </tr> <tr> <td>1</td> <td>Manual Speed 1 (def)</td> <td></td> </tr> <tr> <td>2</td> <td>Manual Speed 2</td> <td></td> </tr> <tr> <td>3</td> <td>Manual Speed 3</td> <td></td> </tr> <tr> <td>4</td> <td>AUTO</td> <td></td> </tr> </tbody> </table>	Register value	Fan Mode	Visualiza tion	0	OFF		1	Manual Speed 1 (def)		2	Manual Speed 2		3	Manual Speed 3		4	AUTO											
Register value	Fan Mode	Visualiza tion																															
0	OFF																																
1	Manual Speed 1 (def)																																
2	Manual Speed 2																																
3	Manual Speed 3																																
4	AUTO																																
41602	1601	0x641	FAN_CURRENT_SPEED	Read/ write	<table border="1"> <thead> <tr> <th>Register value</th> <th>Fan Mode</th> <th>Comment</th> </tr> </thead> <tbody> <tr> <td></td> <td></td> <td></td> </tr> </tbody> </table>	Register value	Fan Mode	Comment																									
Register value	Fan Mode	Comment																															

Modbus Address	Decimal Address	Hex Address	Register Name	Access	Description		
					0	OFF(def)	Fan is OFF
					1	Manual Speed 1	Fan works in Speed 1 manual mode
					2	Manual Speed 2	Fan works in Speed 2 manual mode
					3	Manual Speed 3	Fan works in Speed 3 manual mode
					4	Auto Speed 1	Fan works in Speed 1 auto mode
					5	Auto Speed 2	Fan works in Speed 2 auto mode
					6	Auto Speed 3	Fan works in Speed 3 auto mode
41603	1602	0x642	FAN_TYPE	Read/ write Memory	Register value	Fan type	Comment
					0	0-10V(def)	Fan is controlled by analog value 0-10 V DC
					1	1-Speed	1-Speed Fan
					2	2-Speed	2-Speed Fan
					3	3-Speed	3-Speed Fan

Modbus Address	Decimal Address	Hex Address	Register Name	Access	Description																				
41604	1603	0x643	FAN_MODE_0 NAME (32-bits)	Read/ write Memory	Name for FAN MODE = 0. Default = OFF																				
41606	1605	0x645	FAN_MODE_1 NAME (32-bits)	Read/ write Memory	Name for FAN MODE = 1. Default = AUTO																				
41608	1607	0x647	FAN_MODE_2 NAME (32-bits)	Read/ write Memory	Name for FAN MODE = 2. Default = _ _1																				
41610	1609	0x649	FAN_MODE_3 NAME (32-bits)	Read/ write Memory	Name for FAN MODE = 3. Default = _ _11																				
41612	1611	0x64B	FAN_MODE_4 NAME (32-bits)	Read/ write Memory	Name for FAN MODE = 4. Default = _111																				
41614	1613	0x64D	FAN_CONFIGURATION	Read/ write Memory	<table border="1"> <thead> <tr> <th>Bit</th> <th>Name</th> <th>0</th> <th>1</th> </tr> </thead> <tbody> <tr> <td>0</td> <td>Visible</td> <td>Not visible</td> <td>Visible(def)</td> </tr> <tr> <td>1</td> <td>Editabl e</td> <td>Not Editable</td> <td>Editabl e(def)</td> </tr> <tr> <td>2</td> <td>Part Editabl e</td> <td>Fully edittable(def)</td> <td>Auto_O ff_Mode</td> </tr> <tr> <td>5</td> <td>FastEdi tMode</td> <td>Not active(def )</td> <td>Active</td> </tr> </tbody> </table>	Bit	Name	0	1	0	Visible	Not visible	Visible(def)	1	Editabl e	Not Editable	Editabl e(def)	2	Part Editabl e	Fully edittable(def)	Auto_O ff_Mode	5	FastEdi tMode	Not active(def )	Active
Bit	Name	0	1																						
0	Visible	Not visible	Visible(def)																						
1	Editabl e	Not Editable	Editabl e(def)																						
2	Part Editabl e	Fully edittable(def)	Auto_O ff_Mode																						
5	FastEdi tMode	Not active(def )	Active																						
41615	1614	0x64E	FAN_ICON_FLASHING_TI ME	Read/ write Memory	The time base for calculating the frequency of the fan icon rotation simulation. By default 500 ms.																				
41701	1700	0x6A4	OCCUPANCY_MODE	Read/ write Memory	Occupancy mode setting from the room panel: 0: unoccupied 1: occupied																				
41702	1701	0x6A5	OCCUPANCY_CURRENT_ STATUS	Read/ write	Occupancy mode setting remotely:																				

Modbus Address	Decimal Address	Hex Address	Register Name	Access	Description																
					<table border="1"> <tr> <td>Register value</td> <td>Occupancy Mode</td> </tr> <tr> <td>0</td> <td>Unoccupied</td> </tr> <tr> <td>1</td> <td>Occupied</td> </tr> <tr> <td>2</td> <td>Standby</td> </tr> <tr> <td>3</td> <td>Forced occupied</td> </tr> </table>	Register value	Occupancy Mode	0	Unoccupied	1	Occupied	2	Standby	3	Forced occupied						
Register value	Occupancy Mode																				
0	Unoccupied																				
1	Occupied																				
2	Standby																				
3	Forced occupied																				
41703	1702	0x6A6	OCCUPANCY_MODE_0 NAME (32-bits)	Read/write Memory	Name for OCCUPANCY MODE = 0. Default = UNOC																
41705	1704	0x6A8	OCCUPANCY_MODE_1 NAME (32-bits)	Read/write Memory	Name for OCCUPANCY MODE = 1. Default = OCC																
41707	1706	0x6AA	OCCUPANCY_CONFIGURATION	Read/write Memory	<table border="1"> <tr> <th>Bit</th> <th>Name</th> <th>0</th> <th>1</th> </tr> <tr> <td>0</td> <td>Visible</td> <td>Not visible</td> <td>Visible(def)</td> </tr> <tr> <td>1</td> <td>Editable</td> <td>Not Editable</td> <td>Editable(def)</td> </tr> <tr> <td>5</td> <td>FastEdit Mode</td> <td>Not active(def)</td> <td>Active</td> </tr> </table>	Bit	Name	0	1	0	Visible	Not visible	Visible(def)	1	Editable	Not Editable	Editable(def)	5	FastEdit Mode	Not active(def)	Active
Bit	Name	0	1																		
0	Visible	Not visible	Visible(def)																		
1	Editable	Not Editable	Editable(def)																		
5	FastEdit Mode	Not active(def)	Active																		

Table 38. List of Modbus registers available for a room panel

## 13.1 List of User-defined Parameters Modbus Registers

The following sections list Modbus registers of user-defined parameters available for the room panel.

### 13.1.1 Main Menu User-defined Parameters Registers

Modbus Address	Decimal Address	Hex Address	Register Name	Access	Description
40051	50	0x32	MAIN_MENU_NUMERIC1 PRESENTVALUE	Read/write Memory	Present value of the parameter.

Modbus Address	Decimal Address	Hex Address	Register Name	Access	Description																																																				
40320	319	0x13F	MAIN_MENU_NUMERIC1 NAME (32-bits)	Read/ write Memory	User-defined parameter name displayed.																																																				
40322	321	0x141	MAIN_MENU_NUMERIC1 PRIORITY	Read/ write Memory	Priority of the parameter for sequence of displaying in the main menu.																																																				
40323	322	0x142	MAIN_MENU_NUMERIC1 CONFIGURATION	Read/ write Memory	<table border="1"> <thead> <tr> <th>Bit</th> <th>Name</th> <th>0</th> <th></th> </tr> </thead> <tbody> <tr> <td>0</td> <td>Active</td> <td>Not active(def)</td> <td>Active(def)</td> </tr> <tr> <td>2</td> <td>FirstPointActive</td> <td>Not decimal(def)</td> <td>Decimal(def)</td> </tr> <tr> <td>3</td> <td>SecondPointActive</td> <td>Not decimal(def)</td> <td>Decimal(def)</td> </tr> <tr> <td>4</td> <td>ThirdPointActive</td> <td>Not decimal(def)</td> <td>Decimal(def)</td> </tr> <tr> <td>6</td> <td>C unit active</td> <td>not_visible(def)</td> <td>visible</td> </tr> <tr> <td>7</td> <td>F unit active</td> <td>not_visible(def)</td> <td>visible</td> </tr> <tr> <td>8</td> <td>Pa unit active</td> <td>not_visible(def)</td> <td>visible</td> </tr> <tr> <td>9</td> <td>Lx unit active</td> <td>not_visible(def)</td> <td>visible</td> </tr> <tr> <td>10</td> <td>ppm unit active</td> <td>not_visible(def)</td> <td>visible</td> </tr> <tr> <td>11</td> <td>m3/h unit active</td> <td>not_visible(def)</td> <td>visible</td> </tr> <tr> <td>12</td> <td>%Rh unit active</td> <td>not_visible(def)</td> <td>visible</td> </tr> <tr> <td>13</td> <td>l/s unit active</td> <td>not_visible(def)</td> <td>visible</td> </tr> </tbody> </table>	Bit	Name	0		0	Active	Not active(def)	Active(def)	2	FirstPointActive	Not decimal(def)	Decimal(def)	3	SecondPointActive	Not decimal(def)	Decimal(def)	4	ThirdPointActive	Not decimal(def)	Decimal(def)	6	C unit active	not_visible(def)	visible	7	F unit active	not_visible(def)	visible	8	Pa unit active	not_visible(def)	visible	9	Lx unit active	not_visible(def)	visible	10	ppm unit active	not_visible(def)	visible	11	m3/h unit active	not_visible(def)	visible	12	%Rh unit active	not_visible(def)	visible	13	l/s unit active	not_visible(def)	visible
Bit	Name	0																																																							
0	Active	Not active(def)	Active(def)																																																						
2	FirstPointActive	Not decimal(def)	Decimal(def)																																																						
3	SecondPointActive	Not decimal(def)	Decimal(def)																																																						
4	ThirdPointActive	Not decimal(def)	Decimal(def)																																																						
6	C unit active	not_visible(def)	visible																																																						
7	F unit active	not_visible(def)	visible																																																						
8	Pa unit active	not_visible(def)	visible																																																						
9	Lx unit active	not_visible(def)	visible																																																						
10	ppm unit active	not_visible(def)	visible																																																						
11	m3/h unit active	not_visible(def)	visible																																																						
12	%Rh unit active	not_visible(def)	visible																																																						
13	l/s unit active	not_visible(def)	visible																																																						

Modbus Address	Decimal Address	Hex Address	Register Name	Access	Description								
					<table border="1"> <tr> <td>14</td> <td>% unit active</td> <td>not_visible(def)</td> <td>visible</td> </tr> <tr> <td>15</td> <td>h unit active</td> <td>not_visible(def)</td> <td>visible</td> </tr> </table>	14	% unit active	not_visible(def)	visible	15	h unit active	not_visible(def)	visible
14	% unit active	not_visible(def)	visible										
15	h unit active	not_visible(def)	visible										
40052	51	0x33	MAIN_MENU_NUMERIC2 PRESENTVALUE	Read/write Memory	Present value of the parameter.								
40325	324	0x144	MAIN_MENU_NUMERIC2 NAME (32-bits)	Read/write Memory	Displaying user-defined parameter name.								
40327	326	0x146	MAIN_MENU_NUMERIC2 PRIORITY	Read/write Memory	Priority of the parameter for sequence of display in the main menu								
40328	327	0x147	MAIN_MENU_NUMERIC2 CONFIGURATION	Read/write Memory	See the table in MAIN_MENU_NUMERIC1 Configuration(30323)								
40340	329	0x149	MAIN_MENU_NUMERIC3 NAME (32-bits)	Read/write Memory	Displaying user-defined parameter name.								
40332	331	0x14B	MAIN_MENU_NUMERIC3 PRIORITY	Read/write Memory	Priority of the parameter for sequence of display in the main menu.								
40333	332	0x14C	MAIN_MENU_NUMERIC3 CONFIGURATION	Read/write Memory	See the table in MAIN_MENU_NUMERIC1 Configuration(30323)								
40054	53	0x35	MAIN_MENU_NUMERIC4 PRESENTVALUE	Read/write Memory	Present value of the parameter.								
40335	334	0x14E	MAIN_MENU_NUMERIC4 NAME (32-bits)	Read/write Memory	Displaying user-defined parameter name.								
40337	336	0x150	MAIN_MENU_NUMERIC4 PRIORITY	Read/write Memory	Priority of the parameter for sequence of display in the main menu.								
40338	337	0x151	MAIN_MENU_NUMERIC4 CONFIGURATION	Read/write Memory	See the table in MAIN_MENU_NUMERIC1 Configuration(30323)								
40055	54	0x36	MAIN_MENU_NUMERIC5 PRESENTVALUE	Read/write Memory	Present value of the parameter								



Modbus Address	Decimal Address	Hex Address	Register Name	Access	Description
40340	339	0x153	MAIN_MENU_NUMERIC5 NAME (32-bits)	Read/ write Memory	Displayed user-defined parameter name.
40342	341	0x155	MAIN_MENU_NUMERIC5 PRIORITY	Read/ write Memory	Priority of the parameter for sequence of display in the main menu.
40343	342	0x156	MAIN_MENU_NUMERIC5 CONFIGURATION	Read/ write Memory	See the table in MAIN_MENU_NUMERIC1 Configuration(30323)
40056	55	0x37	MAIN_MENU_NUMERIC6 PRESENTVALUE	Read/ write Memory	Present value of the parameter
40345	344	0x158	MAIN_MENU_NUMERIC6 NAME (32-bits)	Read/ write Memory	Displaying user-defined parameter name.
40347	346	0x15A	MAIN_MENU_NUMERIC6 PRIORITY	Read/ write Memory	Priority of the parameter for sequence of display in the main menu.
40348	347	0x15B	MAIN_MENU_NUMERIC6 CONFIGURATION	Read/ write Memory	See the table in MAIN_MENU_NUMERIC1 Configuration(30323)
40350	349	0x15D	MAIN_MENU_NUMERIC7 NAME (32-bits)	Read/ write Memory	Displaying user-defined parameter name.
40057	56	0x38	MAIN_MENU_NUMERIC7 PRESENTVALUE	Read/ write Memory	Present value of the parameter.
40352	351	0x15E	MAIN_MENU_NUMERIC7 PRIORITY	Read/ write Memory	Priority of the parameter for sequence of display in the main menu.
40353	352	0x15F	MAIN_MENU_NUMERIC7 CONFIGURATION	Read/ write Memory	See the table in MAIN_MENU_NUMERIC1 Configuration(30323)
40058	57	0x39	MAIN_MENU_NUMERIC8 PRESENTVALUE	Read/ write Memory	Present value of the parameter.
40355	354	0x162	MAIN_MENU_NUMERIC8 NAME (32-bits)	Read/ write Memory	Displaying user-defined parameter name.

Modbus Address	Decimal Address	Hex Address	Register Name	Access	Description																								
40357	356	0x164	MAIN_MENU_NUMERIC8 PRIORITY	Read/ write Memory	Priority of the parameter for sequence of display in the main menu.																								
40358	357	0x165	MAIN_MENU_NUMERIC8 CONFIGURATION	Read/ write Memory	See the table in MAIN_MENU_NUMERIC1 Configuratio n(30323)																								
40107	106	0x6A	MAIN_MENU_BOOLEAN ALLPRESENTVALUES	Read/ write Memory	<table border="1"> <thead> <tr> <th>Bit</th> <th>Name</th> <th>0</th> <th>1</th> </tr> </thead> <tbody> <tr> <td>0</td> <td>Boolean1 PresentVa lue</td> <td>Not active(de f)</td> <td>Activ e</td> </tr> <tr> <td>1</td> <td>Boolean2 PresentVa lue</td> <td>Not active(de f)</td> <td>Activ e</td> </tr> <tr> <td>...</td> <td>...</td> <td>...</td> <td>...</td> </tr> <tr> <td>6</td> <td>Boolean7 PresentVa lue</td> <td>Not active(de f)</td> <td>Activ e</td> </tr> <tr> <td>7</td> <td>Boolean8 PresentVa lue</td> <td>Not active(de f)</td> <td>Activ e</td> </tr> </tbody> </table>	Bit	Name	0	1	0	Boolean1 PresentVa lue	Not active(de f)	Activ e	1	Boolean2 PresentVa lue	Not active(de f)	Activ e	...	...	...	...	6	Boolean7 PresentVa lue	Not active(de f)	Activ e	7	Boolean8 PresentVa lue	Not active(de f)	Activ e
Bit	Name	0	1																										
0	Boolean1 PresentVa lue	Not active(de f)	Activ e																										
1	Boolean2 PresentVa lue	Not active(de f)	Activ e																										
...	...	...	...																										
6	Boolean7 PresentVa lue	Not active(de f)	Activ e																										
7	Boolean8 PresentVa lue	Not active(de f)	Activ e																										
40114	113	0x71	MAIN_MENU_BOOLEAN 1 PRESENTVALUE	Read/ write Memory	Present value of the parameter.																								
40360	359	0x167	MAIN_MENU_BOOLEAN 1 NAME (32-bits)	Read/ write Memory	Displaying user-defined parameter name.																								
40362	361	0x169	MAIN_MENU_BOOLEAN 1 TRUETEXT (32-bits)	Read/ write Memory	Text for the parameter's true value.																								
40364	363	0x16B	MAIN_MENU_BOOLEAN 1 FALSETEXT (32-bits)	Read/ write Memory	Text for the parameter's false value.																								
40366	365	0x16D	MAIN_MENU_BOOLEAN 1 PRIORITY	Read/ write Memory	Priority of the parameter for sequence of display in the main menu.																								

Modbus Address	Decimal Address	Hex Address	Register Name	Access	Description								
40367	366	0x16E	MAIN_MENU_BOOLEAN 1 CONFIGURATION	Read/ write Memory	<table border="1"> <thead> <tr> <th>Bit</th> <th>Name</th> <th>0</th> <th>1</th> </tr> </thead> <tbody> <tr> <td>0</td> <td>Active</td> <td>Not active(def)</td> <td>Active</td> </tr> </tbody> </table>	Bit	Name	0	1	0	Active	Not active(def)	Active
Bit	Name	0	1										
0	Active	Not active(def)	Active										
40115	114	0x72	MAIN_MENU_BOOLEAN 2 PRESENTVALUE	Read/ write Memory	Present value of the parameter.								
40369	368	0x170	MAIN_MENU_BOOLEAN 2 NAME (32-bits)	Read/ write Memory	Displaying user-defined parameter name.								
40371	370	0x172	MAIN_MENU_BOOLEAN 2 TRUETEXT (32-bits)	Read/ write Memory	Text for the parameter's true value.								
40373	372	0x174	MAIN_MENU_BOOLEAN 2 FALSETEXT (32-bits)	Read/ write Memory	Text for the parameter's false value.								
40375	374	0x176	MAIN_MENU_BOOLEAN 2 PRIORITY	Read/ write Memory	Priority of the parameter for sequence of display in the main menu.								
40376	375	0x177	MAIN_MENU_BOOLEAN 2 CONFIGURATION	Read/ write Memory	<table border="1"> <thead> <tr> <th>Bit</th> <th>Name</th> <th>0</th> <th>1</th> </tr> </thead> <tbody> <tr> <td>0</td> <td>Active</td> <td>Not active(def)</td> <td>Active</td> </tr> </tbody> </table>	Bit	Name	0	1	0	Active	Not active(def)	Active
Bit	Name	0	1										
0	Active	Not active(def)	Active										
40116	115	0x73	MAIN_MENU_BOOLEAN 3 PRESENTVALUE	Read/ write Memory	Present value of the parameter.								
40378	377	0x179	MAIN_MENU_BOOLEAN 3 NAME (32-bits)	Read/ write Memory	Displaying user-defined parameter name.								
40380	379	0x17B	MAIN_MENU_BOOLEAN 3 TRUETEXT (32-bits)	Read/ write Memory	Text for the parameter's true value.								
40382	381	0x17D	MAIN_MENU_BOOLEAN 3 FALSETEXT (32-bits)	Read/ write Memory	Text for the parameter's false value.								
40384	383	0x17F	MAIN_MENU_BOOLEAN 3 PRIORITY	Read/ write Memory	Priority of the parameter for sequence of display in the main menu.								

Modbus Address	Decimal Address	Hex Address	Register Name	Access	Description								
40385	384	0x180	MAIN_MENU_BOOLEAN 3 CONFIGURATION	Read/ write Memory	<table border="1"> <thead> <tr> <th>Bit</th> <th>Name</th> <th>0</th> <th>1</th> </tr> </thead> <tbody> <tr> <td>0</td> <td>Active</td> <td>Not active(def)</td> <td>Active</td> </tr> </tbody> </table>	Bit	Name	0	1	0	Active	Not active(def)	Active
Bit	Name	0	1										
0	Active	Not active(def)	Active										
40117	116	0x74	MAIN_MENU_BOOLEAN 4 PRESENTVALUE	Read/ write Memory	Present value of the parameter.								
40387	386	0x182	MAIN_MENU_BOOLEAN 4 NAME (32-bits)	Read/ write Memory	Displaying user-defined parameter name.								
40389	388	0x184	MAIN_MENU_BOOLEAN 4 TRUETEXT (32-bits)	Read/ write Memory	Text for the parameter's true value.								
40391	390	0x186	MAIN_MENU_BOOLEAN 4 FALSETEXT (32-bits)	Read/ write Memory	Text for the parameter's false value.								
40393	392	0x188	MAIN_MENU_BOOLEAN 4 PRIORITY	Read/ write Memory	Priority of the parameter for sequence of display in the main menu.								
40394	393	0x189	MAIN_MENU_BOOLEAN 4 CONFIGURATION	Read/ write Memory	<table border="1"> <thead> <tr> <th>Bit</th> <th>Name</th> <th>0</th> <th>1</th> </tr> </thead> <tbody> <tr> <td>0</td> <td>Active</td> <td>Not active(def)</td> <td>Active</td> </tr> </tbody> </table>	Bit	Name	0	1	0	Active	Not active(def)	Active
Bit	Name	0	1										
0	Active	Not active(def)	Active										
40118	117	0x75	MAIN_MENU_BOOLEAN 5 PRESENTVALUE	Read/ write Memory	Present value of the parameter.								
40396	395	0x18B	MAIN_MENU_BOOLEAN 5 NAME (32-bits)	Read/ write Memory	Displaying user-defined parameter name.								
40398	397	0x18D	MAIN_MENU_BOOLEAN 5 TRUETEXT (32-bits)	Read/ write Memory	Text for the parameter's true value.								
40400	399	0x18F	MAIN_MENU_BOOLEAN 5 FALSETEXT (32-bits)	Read/ write Memory	Text for the parameter's false value.								
40402	401	0x191	MAIN_MENU_BOOLEAN 5 PRIORITY	Read/ write Memory	Priority of the parameter for sequence of display in the main menu.								

Modbus Address	Decimal Address	Hex Address	Register Name	Access	Description								
40403	402	0x192	MAIN_MENU_BOOLEAN 5 CONFIGURATION	Read/ write Memory	<table border="1"> <thead> <tr> <th>Bit</th> <th>Name</th> <th>0</th> <th>1</th> </tr> </thead> <tbody> <tr> <td>0</td> <td>Active</td> <td>Not active(def)</td> <td>Active</td> </tr> </tbody> </table>	Bit	Name	0	1	0	Active	Not active(def)	Active
Bit	Name	0	1										
0	Active	Not active(def)	Active										
40119	118	0x76	MAIN_MENU_BOOLEAN 6 PRESENTVALUE	Read/ write Memory	Present value of the parameter.								
40405	404	0x194	MAIN_MENU_BOOLEAN 6 NAME (32-bits)	Read/ write Memory	Displaying user-defined parameter name.								
40407	406	0x196	MAIN_MENU_BOOLEAN 6 TRUETEXT (32-bits)	Read/ write Memory	Text for the parameter's true value.								
40409	408	0x198	MAIN_MENU_BOOLEAN 6 FALSETEXT (32-bits)	Read/ write Memory	Text for the parameter's false value.								
40411	410	0x19A	MAIN_MENU_BOOLEAN 6 PRIORITY	Read/ write Memory	Priority of the parameter for sequence of display in the main menu.								
40412	411	0x19B	MAIN_MENU_BOOLEAN 6 CONFIGURATION	Read/ write Memory	<table border="1"> <thead> <tr> <th>Bit</th> <th>Name</th> <th>0</th> <th>1</th> </tr> </thead> <tbody> <tr> <td>0</td> <td>Active</td> <td>Not active(def)</td> <td>Active</td> </tr> </tbody> </table>	Bit	Name	0	1	0	Active	Not active(def)	Active
Bit	Name	0	1										
0	Active	Not active(def)	Active										
40120	119	0x77	MAIN_MENU_BOOLEAN 7 PRESENTVALUE	Read/ write Memory	Present value of the parameter.								
40414	413	0x19D	MAIN_MENU_BOOLEAN 7 NAME (32-bits)	Read/ write Memory	Displaying user-defined parameter name.								
40416	415	0x19F	MAIN_MENU_BOOLEAN 7 TRUETEXT (32-bits)	Read/ write Memory	Text for the parameter's true value.								
40418	417	0x1A1	MAIN_MENU_BOOLEAN 7 FALSETEXT (32-bits)	Read/ write Memory	Text for the parameter's false value.								
40420	419	0x1A3	MAIN_MENU_BOOLEAN 7 PRIORITY	Read/ write Memory	Priority of the parameter for sequence of display in the main menu.								

Modbus Address	Decimal Address	Hex Address	Register Name	Access	Description								
40421	420	0x1A4	MAIN_MENU_BOOLEAN 7 CONFIGURATION	Read/ write Memory	<table border="1"> <thead> <tr> <th>Bit</th> <th>Name</th> <th>0</th> <th>1</th> </tr> </thead> <tbody> <tr> <td>0</td> <td>Active</td> <td>Not active(def)</td> <td>Active</td> </tr> </tbody> </table>	Bit	Name	0	1	0	Active	Not active(def)	Active
Bit	Name	0	1										
0	Active	Not active(def)	Active										
40121	120	0x78	MAIN_MENU_BOOLEAN 8 PRESENTVALUE	Read/ write Memory	Present value of the parameter.								
40423	422	0x1A6	MAIN_MENU_BOOLEAN 8 NAME (32-bits)	Read/ write Memory	Displaying user-defined parameter name.								
40425	424	0x1A8	MAIN_MENU_BOOLEAN 8 TRUETEXT (32-bits)	Read/ write Memory	Text for the parameter's true value.								
40427	426	0x1AA	MAIN_MENU_BOOLEAN 8 FALSETEXT (32-bits)	Read/ write Memory	Text for the parameter's false value.								
40429	428	0x1AC	MAIN_MENU_BOOLEAN 8 PRIORITY	Read/ write Memory	Priority of the parameter for sequence of display in the main menu.								
40440	429	0x1AD	MAIN_MENU_BOOLEAN 8 CONFIGURATION	Read/ write Memory	<table border="1"> <thead> <tr> <th>Bit</th> <th>Name</th> <th>0</th> <th>1</th> </tr> </thead> <tbody> <tr> <td>0</td> <td>Active</td> <td>Not active(def)</td> <td>Active</td> </tr> </tbody> </table>	Bit	Name	0	1	0	Active	Not active(def)	Active
Bit	Name	0	1										
0	Active	Not active(def)	Active										

Table 39. List of main menu user-defined parameters registers

### 13.1.2 Temperature Submenu Registers

Modbus Address	Decimal Address	Hex Address	Register Name	Access	Description
40059	58	0x3A	TEMPERATURE_NUMERI C1 PRESENT_VALUE	Read/ write Memory	Present value of the parameter.
40501	500	0x13F	TEMPERATURE_MENU ACTIVE_POINTS	Read/ write Memory	Number of active parameters in submenu.
40504	503	0x1F7	TEMPERATURE_NUMERI C1 NAME (32-bits)	Read/ write Memory	Displaying user-defined parameter name.

Modbus Address	Decimal Address	Hex Address	Register Name	Access	Description																																								
40506	505	0x1F9	TEMPERATURE_NUMERICAL STEP	Read/ write Memory	Step of the parameter value change. The default value is 0.																																								
40507	506	0x1FA	TEMPERATURE_NUMERICAL LOW_LIMIT	Read/ write Memory	Minimum value of the parameter. The default value is 0.																																								
40508	507	0x1FB	TEMPERATURE_NUMERICAL HIGH_LIMIT	Read/ write Memory	Maximum value of the parameter. The default value is 0.																																								
40509	508	0x1FC	TEMPERATURE_NUMERICAL PRIORITY	Read/ write Memory	Priority of the parameter for sequence of display in the submenu.																																								
40510	509	0x1FD	TEMPERATURE_NUMERICAL CONFIGURATION	Read/ write Memory	<table border="1"> <thead> <tr> <th>Bit</th> <th>Name</th> <th>0</th> <th>1</th> </tr> </thead> <tbody> <tr> <td>0</td> <td>Active</td> <td>Not active(def)</td> <td>Active(def)</td> </tr> <tr> <td>2</td> <td>FirstPointActive</td> <td>Not decimal(def)</td> <td>Decimal(def)</td> </tr> <tr> <td>3</td> <td>SecondPointActive</td> <td>Not decimal(def)</td> <td>Decimal(def)</td> </tr> <tr> <td>4</td> <td>ThirdPointActive</td> <td>Not decimal(def)</td> <td>Decimal(def)</td> </tr> <tr> <td>6</td> <td>C unit active</td> <td>not_visible(def)</td> <td>visible</td> </tr> <tr> <td>7</td> <td>F unit active</td> <td>not_visible(def)</td> <td>visible</td> </tr> <tr> <td>8</td> <td>Pa unit active</td> <td>not_visible(def)</td> <td>visible</td> </tr> <tr> <td>9</td> <td>Lx unit active</td> <td>not_visible(def)</td> <td>visible</td> </tr> <tr> <td>10</td> <td>ppm unit active</td> <td>not_visible(def)</td> <td>visible</td> </tr> </tbody> </table>	Bit	Name	0	1	0	Active	Not active(def)	Active(def)	2	FirstPointActive	Not decimal(def)	Decimal(def)	3	SecondPointActive	Not decimal(def)	Decimal(def)	4	ThirdPointActive	Not decimal(def)	Decimal(def)	6	C unit active	not_visible(def)	visible	7	F unit active	not_visible(def)	visible	8	Pa unit active	not_visible(def)	visible	9	Lx unit active	not_visible(def)	visible	10	ppm unit active	not_visible(def)	visible
Bit	Name	0	1																																										
0	Active	Not active(def)	Active(def)																																										
2	FirstPointActive	Not decimal(def)	Decimal(def)																																										
3	SecondPointActive	Not decimal(def)	Decimal(def)																																										
4	ThirdPointActive	Not decimal(def)	Decimal(def)																																										
6	C unit active	not_visible(def)	visible																																										
7	F unit active	not_visible(def)	visible																																										
8	Pa unit active	not_visible(def)	visible																																										
9	Lx unit active	not_visible(def)	visible																																										
10	ppm unit active	not_visible(def)	visible																																										

Modbus Address	Decimal Address	Hex Address	Register Name	Access	Description																				
					<table border="1"> <tr> <td>1</td> <td>m3/h unit active</td> <td>not_visible(def)</td> <td>visible</td> </tr> <tr> <td>1</td> <td>%Rh unit active</td> <td>not_visible(def)</td> <td>visible</td> </tr> <tr> <td>1</td> <td>l/s unit active</td> <td>not_visible(def)</td> <td>visible</td> </tr> <tr> <td>1</td> <td>% unit active</td> <td>not_visible(def)</td> <td>visible</td> </tr> <tr> <td>1</td> <td>h unit active</td> <td>not_visible(def)</td> <td>visible</td> </tr> </table>	1	m3/h unit active	not_visible(def)	visible	1	%Rh unit active	not_visible(def)	visible	1	l/s unit active	not_visible(def)	visible	1	% unit active	not_visible(def)	visible	1	h unit active	not_visible(def)	visible
1	m3/h unit active	not_visible(def)	visible																						
1	%Rh unit active	not_visible(def)	visible																						
1	l/s unit active	not_visible(def)	visible																						
1	% unit active	not_visible(def)	visible																						
1	h unit active	not_visible(def)	visible																						
40060	59	0x3B	TEMPERATURE_NUMERIC2 PRESENT_VALUE	Read/write Memory	Present value of the parameter.																				
40513	512	0x200	TEMPERATURE_NUMERIC2 NAME (32-bits)	Read/write Memory	Displaying user-defined parameter name. Default name: Num2																				
40515	514	0x202	TEMPERATURE_NUMERIC2 STEP	Read/write Memory	Step of the parameter value change. The default value is 0.																				
40516	515	0x203	TEMPERATURE_NUMERIC2 LOW_LIMIT	Read/write Memory	Minimum value of the parameter. The default value is 0.																				
40517	516	0x204	TEMPERATURE_NUMERIC2 HIGH_LIMIT	Read/write Memory	Maximum value of the parameter. The default value is 0.																				
40518	517	0x205	TEMPERATURE_NUMERIC2 PRIORITY	Read/write Memory	Priority of the parameter for sequence of display in the submenu.																				
40519	518	0x1FD	TEMPERATURE_NUMERIC2 CONFIGURATION	Read/write Memory	See the table in TEMPERATURE_NUMERIC1 Configuration(40510)																				
40061	60	0x3C	TEMPERATURE_NUMERIC3 PRESENT_VALUE	Read/write Memory	Present value of the parameter.																				
40522	521	0x209	TEMPERATURE_NUMERIC3 NAME (32-bits)	Read/write Memory	Displaying user-defined parameter name. Default name: Num2																				



Modbus Address	Decimal Address	Hex Address	Register Name	Access	Description
40524	523	0x20B	TEMPERATURE_NUMERIC3 STEP	Read/ write Memory	Step of the parameter value change. The default value is 0.
40525	524	0x20C	TEMPERATURE_NUMERIC3 LOW_LIMIT	Read/ write Memory	Minimum value of the parameter. The default value is 0.
40526	525	0x20D	TEMPERATURE_NUMERIC3 HIGH_LIMIT	Read/ write Memory	Maximum value of the parameter. The default value is 0.
40527	526	0x20E	TEMPERATURE_NUMERIC3 PRIORITY	Read/ write Memory	Priority of the parameter for sequence of display in the submenu.
40528	527	0x20F	TEMPERATURE_NUMERIC3 CONFIGURATION	Read/ write Memory	See the table in TEMPERATURE_NUMERIC1 Configuration(40510)
40062	61	0x3D	TEMPERATURE_NUMERIC4 PRESENT_VALUE	Read/ write Memory	Present value of the parameter.
40531	530	0x212	TEMPERATURE_NUMERIC4 NAME (32-bits)	Read/ write Memory	Displaying user-defined parameter name. Default name: Num2
40533	532	0x214	TEMPERATURE_NUMERIC4 STEP	Read/ write Memory	Step of the parameter value change. The default value is 0.
40534	533	0x215	TEMPERATURE_NUMERIC4 LOW_LIMIT	Read/ write Memory	Minimum value of the parameter. The default value is 0.
40535	534	0x216	TEMPERATURE_NUMERIC4 HIGH_LIMIT	Read/ write Memory	Maximum value of the parameter. The default value is 0.
40536	535	0x217	TEMPERATURE_NUMERIC4 PRIORITY	Read/ write Memory	Priority of the parameter for sequence of display in the submenu.
40537	536	0x218	TEMPERATURE_NUMERIC4 CONFIGURATION	Read/ write Memory	See the table in TEMPERATURE_NUMERIC1 Configuration(40510)
40063	62	0x3E	TEMPERATURE_NUMERIC5 PRESENT_VALUE	Read/ write Memory	Present value of the parameter.

Modbus Address	Decimal Address	Hex Address	Register Name	Access	Description
40540	539	0x21B	TEMPERATURE_NUMERIC5 NAME (32-bits)	Read/ write Memory	Displaying user-defined parameter name. Default name: Num2
40542	541	0x21D	TEMPERATURE_NUMERIC5 STEP	Read/ write Memory	Step of the parameter value change. The default value is 0.
40543	542	0x21E	TEMPERATURE_NUMERIC5 LOW_LIMIT	Read/ write Memory	Minimum value of the parameter. The default value is 0.
40544	543	0x21F	TEMPERATURE_NUMERIC5 HIGH_LIMIT	Read/ write Memory	Maximum value of the parameter. The default value is 0.
40545	544	0x220	TEMPERATURE_NUMERIC5 PRIORITY	Read/ write Memory	Priority of the parameter for sequence of display in the submenu.
40546	545	0x221	TEMPERATURE_NUMERIC5 CONFIGURATION	Read/ write Memory	See the table in TEMPERATURE_NUMERIC1 Configuration(40510)
40064	63	0x3F	TEMPERATURE_NUMERIC6 PRESENT_VALUE	Read/ write Memory	Present value of the parameter.
40549	548	0x224	TEMPERATURE_NUMERIC6 NAME (32-bits)	Read/ write Memory	Displaying user-defined parameter name. Default name: Num2
40551	550	0x226	TEMPERATURE_NUMERIC6 STEP	Read/ write Memory	Step of the parameter value change. The default value is 0.
40552	551	0x227	TEMPERATURE_NUMERIC6 LOW_LIMIT	Read/ write Memory	Minimum value of the parameter. The default value is 0.
40553	552	0x228	TEMPERATURE_NUMERIC6 HIGH_LIMIT	Read/ write Memory	Maximum value of the parameter. The default value is 0.
40554	553	0x229	TEMPERATURE_NUMERIC6 PRIORITY	Read/ write Memory	Priority of the parameter for sequence of display in the submenu.
40555	554	0x22A	TEMPERATURE_NUMERIC6 CONFIGURATION	Read/ write Memory	See the table in TEMPERATURE_NUMERIC1 Configuration(40510)

Modbus Address	Decimal Address	Hex Address	Register Name	Access	Description
40065	64	0x40	TEMPERATURE_NUMERIC7 PRESENT_VALUE	Read/ write Memory	Present value of the parameter.
40558	557	0x22D	TEMPERATURE_NUMERIC7 NAME (32-bits)	Read/ write Memory	Displaying user-defined parameter name. Default name: Num2
40560	559	0x22F	TEMPERATURE_NUMERIC7 STEP	Read/ write Memory	Step of the parameter value change. The default value is 0.
40561	560	0x230	TEMPERATURE_NUMERIC7 LOW_LIMIT	Read/ write Memory	Minimum value of the parameter. The default value is 0.
40562	561	0x231	TEMPERATURE_NUMERIC7 HIGH_LIMIT	Read/ write Memory	Maximum value of the parameter. The default value is 0.
40563	562	0x232	TEMPERATURE_NUMERIC7 PRIORITY	Read/ write Memory	Priority of the parameter for sequence of display in the submenu.
40564	563	0x233	TEMPERATURE_NUMERIC7 CONFIGURATION	Read/ write Memory	See the table in TEMPERATURE_NUMERIC1 Configuration(40510)
40066	65	0x41	TEMPERATURE_NUMERIC8 PRESENT_VALUE	Read/ write Memory	Present value of the parameter.
40567	566	0x236	TEMPERATURE_NUMERIC8 NAME (32-bits)	Read/ write Memory	Displaying user-defined parameter name. Default name: Num2
40569	568	0x238	TEMPERATURE_NUMERIC8 STEP	Read/ write Memory	Step of the parameter value change. The default value is 0.
40570	569	0x239	TEMPERATURE_NUMERIC8 LOW_LIMIT	Read/ write Memory	Minimum value of the parameter. The default value is 0.
40571	570	0x240	TEMPERATURE_NUMERIC8 HIGH_LIMIT	Read/ write Memory	Maximum value of the parameter. The default value is 0.
40572	571	0x241	TEMPERATURE_NUMERIC8 PRIORITY	Read/ write Memory	Priority of the parameter for sequence of display in the submenu.

Modbus Address	Decimal Address	Hex Address	Register Name	Access	Description												
40573	572	0x242	TEMPERATURE_NUMERIC8 CONFIGURATION	Read/write Memory	See the table in TEMPERATURE_NUMERIC1 Configuration(40510)												
40108	107	0x6B	TEMPERATURE_BOOLEAN_ALL_PRESENT_VALUES	Read/write Memory	See the table in 30107 register												
40122	121	0x79	TEMPERATURE_BOOLEAN1_PRESENT_VALUE	Read/write Memory	Present value of the parameter.												
40576	575	0x23F	TEMPERATURE_BOOLEAN1_NAME (32-bits)	Read/write Memory	Displaying user-defined parameter name.												
40578	577	0x241	TEMPERATURE_BOOLEAN1_TRUETEXT (32-bits)	Read/write Memory	Text for the parameter's true value.												
40580	579	0x243	TEMPERATURE_BOOLEAN1_FALSETEXT (32-bits)	Read/write Memory	Text for the parameter 's false value.												
40582	581	0x245	TEMPERATURE_BOOLEAN1_PRIORITY	Read/write Memory	Priority of the parameter for sequence of display in the submenu.												
40583	582	0x246	TEMPERATURE_BOOLEAN1_CONFIGURATION	Read/write Memory	<table border="1"> <thead> <tr> <th>Bit</th> <th>Name</th> <th>0</th> <th>1</th> </tr> </thead> <tbody> <tr> <td>0</td> <td>Active</td> <td>Not active(def)</td> <td>Active</td> </tr> <tr> <td>1</td> <td>Editable</td> <td>Not editable</td> <td>Editable(def)</td> </tr> </tbody> </table>	Bit	Name	0	1	0	Active	Not active(def)	Active	1	Editable	Not editable	Editable(def)
Bit	Name	0	1														
0	Active	Not active(def)	Active														
1	Editable	Not editable	Editable(def)														
40123	122	0x7A	TEMPERATURE_BOOLEAN2_PRESENT_VALUE	Read/write Memory	Present value of the parameter.												
40586	585	0x249	TEMPERATURE_BOOLEAN2_NAME (32-bits)	Read/write Memory	Displaying user-defined parameter name.												
40588	587	0x251	TEMPERATURE_BOOLEAN2_TRUETEXT (32-bits)	Read/write Memory	Text for the parameter's true value.												

Modbus Address	Decimal Address	Hex Address	Register Name	Access	Description												
40590	589	0x253	TEMPERATURE_BOOLEAN2 FALSETEXT (32-bits)	Read/ write Memory	Text for the parameter 's false value.												
40592	591	0x255	TEMPERATURE_BOOLEAN2 PRIORITY	Read/ write Memory	Priority of the parameter for sequence of display in the submenu.												
40593	592	0x256	TEMPERATURE_BOOLEAN2 CONFIGURATION	Re Read/ write Memory	<table border="1"> <thead> <tr> <th>Bit</th> <th>Name</th> <th>0</th> <th>1</th> </tr> </thead> <tbody> <tr> <td>0</td> <td>Active</td> <td>Not active(def)</td> <td>Active</td> </tr> <tr> <td>1</td> <td>Editabile</td> <td>Not editable</td> <td>Editable(def)</td> </tr> </tbody> </table>	Bit	Name	0	1	0	Active	Not active(def)	Active	1	Editabile	Not editable	Editable(def)
Bit	Name	0	1														
0	Active	Not active(def)	Active														
1	Editabile	Not editable	Editable(def)														
40124	123	0x7B	TEMPERATURE_BOOLEAN3 PRESENT_VALUE	Read/ write Memory	Present value of the parameter.												
40596	595	0x253	TEMPERATURE_BOOLEAN3 NAME (32-bits)	Read/ write Memory	Displaying user-defined parameter name.												
40598	597	0x255	TEMPERATURE_BOOLEAN3 TRUETEXT (32-bits)	Read/ write Memory	Text for the parameter's true value.												
40600	599	0x257	TEMPERATURE_BOOLEAN3 FALSETEXT (32-bits)	Read/ write Memory	Text for the parameter 's false value.												
40602	601	0x259	TEMPERATURE_BOOLEAN3 PRIORITY	Read/ write Memory	Priority of the parameter for sequence of display in the submenu.												
40603	602	0x25A	TEMPERATURE_BOOLEAN3 CONFIGURATION	Re Read/ write Memory	<table border="1"> <thead> <tr> <th>Bit</th> <th>Name</th> <th>0</th> <th>1</th> </tr> </thead> <tbody> <tr> <td>0</td> <td>Active</td> <td>Not active(def)</td> <td>Active</td> </tr> <tr> <td>1</td> <td>Editabile</td> <td>Not editable</td> <td>Editable(def)</td> </tr> </tbody> </table>	Bit	Name	0	1	0	Active	Not active(def)	Active	1	Editabile	Not editable	Editable(def)
Bit	Name	0	1														
0	Active	Not active(def)	Active														
1	Editabile	Not editable	Editable(def)														

Modbus Address	Decimal Address	Hex Address	Register Name	Access	Description												
40125	124	0x7C	TEMPERATURE_BOOLEAN4 PRESENT_VALUE	Read/write Memory	Present value of the parameter.												
40606	605	0x25D	TEMPERATURE_BOOLEAN4 NAME (32-bits)	Read/write Memory	Displaying user-defined parameter name.												
40608	607	0x25F	TEMPERATURE_BOOLEAN4 TRUETEXT (32-bits)	Read/write Memory	Text for the parameter's true value.												
40610	609	0x261	TEMPERATURE_BOOLEAN4 FALSETEXT (32-bits)	Read/write Memory	Text for the parameter's false value.												
40612	611	0x263	TEMPERATURE_BOOLEAN4 PRIORITY	Read/write Memory	Priority of the parameter for sequence of display in the submenu.												
40613	612	0x264	TEMPERATURE_BOOLEAN4 CONFIGURATION	Read/write Memory	<table border="1"> <thead> <tr> <th>Bit</th> <th>Name</th> <th>0</th> <th>1</th> </tr> </thead> <tbody> <tr> <td>0</td> <td>Active</td> <td>Not active(def)</td> <td>Active</td> </tr> <tr> <td>1</td> <td>Editable</td> <td>Not editable</td> <td>Editable(def)</td> </tr> </tbody> </table>	Bit	Name	0	1	0	Active	Not active(def)	Active	1	Editable	Not editable	Editable(def)
Bit	Name	0	1														
0	Active	Not active(def)	Active														
1	Editable	Not editable	Editable(def)														
40126	125	0x7D	TEMPERATURE_BOOLEAN5 PRESENT_VALUE	Read/write Memory	Present value of the parameter.												
40616	615	0x267	TEMPERATURE_BOOLEAN5 NAME (32-bits)	Read/write Memory	Displaying user-defined parameter name.												
40618	617	0x269	TEMPERATURE_BOOLEAN5 TRUETEXT (32-bits)	Read/write Memory	Text for the parameter's true value.												
40620	619	0x271	TEMPERATURE_BOOLEAN5 FALSETEXT (32-bits)	Read/write Memory	Text for the parameter's false value.												
40622	621	0x273	TEMPERATURE_BOOLEAN5 PRIORITY	Read/write Memory	Priority of the parameter for sequence of display in the submenu.												

Modbus Address	Decimal Address	Hex Address	Register Name	Access	Description												
40623	622	0x274	TEMPERATURE_BOOLEAN5 CONFIGURATION	Read/write Memory	<table border="1"> <thead> <tr> <th>Bit</th> <th>Name</th> <th>0</th> <th>1</th> </tr> </thead> <tbody> <tr> <td>0</td> <td>Active</td> <td>Not active(def)</td> <td>Active</td> </tr> <tr> <td>1</td> <td>Editable</td> <td>Not editable</td> <td>Editable(def)</td> </tr> </tbody> </table>	Bit	Name	0	1	0	Active	Not active(def)	Active	1	Editable	Not editable	Editable(def)
Bit	Name	0	1														
0	Active	Not active(def)	Active														
1	Editable	Not editable	Editable(def)														
40127	126	0x7E	TEMPERATURE_BOOLEAN6 PRESENT_VALUE	Read/write Memory	Present value of the parameter.												
40626	625	0x271	TEMPERATURE_BOOLEAN6 NAME (32-bits)	Read/write Memory	Displaying user-defined parameter name.												
40628	627	0x273	TEMPERATURE_BOOLEAN6 TRUETEXT (32-bits)	Read/write Memory	Text for the parameter's true value.												
40630	629	0x275	TEMPERATURE_BOOLEAN6 FALSETEXT (32-bits)	Read/write Memory	Text for the parameter's false value.												
40632	631	0x277	TEMPERATURE_BOOLEAN6 PRIORITY	Read/write Memory	Priority of the parameter for sequence of display in the submenu.												
40633	632	0x278	TEMPERATURE_BOOLEAN6 CONFIGURATION	Read/write Memory	<table border="1"> <thead> <tr> <th>Bit</th> <th>Name</th> <th>0</th> <th>1</th> </tr> </thead> <tbody> <tr> <td>0</td> <td>Active</td> <td>Not active(def)</td> <td>Active</td> </tr> <tr> <td>1</td> <td>Editable</td> <td>Not editable</td> <td>Editable(def)</td> </tr> </tbody> </table>	Bit	Name	0	1	0	Active	Not active(def)	Active	1	Editable	Not editable	Editable(def)
Bit	Name	0	1														
0	Active	Not active(def)	Active														
1	Editable	Not editable	Editable(def)														
40128	127	0x7F	TEMPERATURE_BOOLEAN7 PRESENT_VALUE	Read/write Memory	Present value of the parameter												
40636	635	0x27B	TEMPERATURE_BOOLEAN7 NAME (32-bits)	Read/write Memory	Displaying user-defined parameter name.												

Modbus Address	Decimal Address	Hex Address	Register Name	Access	Description												
40638	637	0x27D	TEMPERATURE_BOOLEAN7 TRUETEXT (32-bits)	Read/ write Memory	Text for the parameter's true value.												
40640	639	0x27F	TEMPERATURE_BOOLEAN7 FALSETEXT (32-bits)	Read/ write Memory	Text for the parameter 's false value.												
40642	641	0x281	TEMPERATURE_BOOLEAN7 PRIORITY	Read/ write Memory	Priority of the parameter for sequence of display in the submenu.												
40643	642	0x282	TEMPERATURE_BOOLEAN7 CONFIGURATION	Read/ write Memory	<table border="1"> <thead> <tr> <th>Bit</th> <th>Name</th> <th>0</th> <th>1</th> </tr> </thead> <tbody> <tr> <td>0</td> <td>Active</td> <td>Not active(def)</td> <td>Active</td> </tr> <tr> <td>1</td> <td>Editabile</td> <td>Not editable</td> <td>Editable(def)</td> </tr> </tbody> </table>	Bit	Name	0	1	0	Active	Not active(def)	Active	1	Editabile	Not editable	Editable(def)
Bit	Name	0	1														
0	Active	Not active(def)	Active														
1	Editabile	Not editable	Editable(def)														
40129	128	0x80	TEMPERATURE_BOOLEAN8 PRESENT_VALUE	Read/ write Memory	Present value of the parameter.												
40646	645	0x285	TEMPERATURE_BOOLEAN8 NAME (32-bits)	Read/ write Memory	Displaying user-defined parameter name.												
40648	647	0x287	TEMPERATURE_BOOLEAN8 TRUETEXT (32-bits)	Read/ write Memory	Text for the parameter's true value.												
40650	649	0x289	TEMPERATURE_BOOLEAN8 FALSETEXT (32-bits)	Read/ write Memory	Text for the parameter 's false value.												
40652	651	0x28B	TEMPERATURE_BOOLEAN8 PRIORITY	Read/ write Memory	Priority of the parameter for sequence of display in the submenu.												
40653	652	0x28C	TEMPERATURE_BOOLEAN8 CONFIGURATION	Read/ write Memory	<table border="1"> <thead> <tr> <th>Bit</th> <th>Name</th> <th>0</th> <th>1</th> </tr> </thead> <tbody> <tr> <td>0</td> <td>Active</td> <td>Not active(def)</td> <td>Active</td> </tr> </tbody> </table>	Bit	Name	0	1	0	Active	Not active(def)	Active				
Bit	Name	0	1														
0	Active	Not active(def)	Active														



Modbus Address	Decimal Address	Hex Address	Register Name	Access	Description			
					1	Editable	Not editable	Editable(def)

Table 40. List of temperature submenu registers

### 13.1.3 Fan Submenu Registers

Modbus Address	Decimal Address	Hex Address	Register Name	Access	Description			
40067	66	0x42	FANNUMERIC1 PRESENT_VALUE	Read/write Memory	Present value of the parameter.			
40654	653	0x28D	FANMENUACTIVEPOINTS	Read/write Memory	Number of active parameters in the submenu.			
40657	656	0x290	FANNUMERIC1 NAME (32-bits)	Read/write Memory	Displaying user-defined parameter name.			
40659	658	0x292	FANNUMERIC1 STEP	Read/write Memory	Step of the parameter value change. The default value is 0.			
40660	659	0x293	FANNUMERIC1 LOW_LIMIT	Read/write Memory	Minimum value of the parameter. The default value is 0.			
40661	660	0x294	FANNUMERIC1 HIGH_LIMIT	Read/write Memory	Maximum value of the parameter. The default value is 0.			
40662	661	0x295	FANNUMERIC1 PRIORITY	Read/write Memory	Priority of the parameter for sequence of display in the submenu.			
40663	662	0x296	FANNUMERIC1 CONFIGURATION	Read/write Memory	Bit	Name	0	1
					0	Active	Not active(def)	Active(def)
					2	FirstPointActive	Not decimal(def)	Decimal(def)

Modbus Address	Decimal Address	Hex Address	Register Name	Access	Description																																																
					<table border="1"> <tr> <td>3</td> <td>SecondPointActive</td> <td>Not decimal(def)</td> <td>Decimal(def)</td> </tr> <tr> <td>4</td> <td>ThirdPointActive</td> <td>Not decimal(def)</td> <td>Decimal(def)</td> </tr> <tr> <td>6</td> <td>C unit active</td> <td>not_visible(def)</td> <td>visible</td> </tr> <tr> <td>7</td> <td>F unit active</td> <td>not_visible(def)</td> <td>visible</td> </tr> <tr> <td>8</td> <td>Pa unit active</td> <td>not_visible(def)</td> <td>visible</td> </tr> <tr> <td>9</td> <td>Lx unit active</td> <td>not_visible(def)</td> <td>visible</td> </tr> <tr> <td>10</td> <td>ppm unit active</td> <td>not_visible(def)</td> <td>visible</td> </tr> <tr> <td>11</td> <td>m3/h unit active</td> <td>not_visible(def)</td> <td>visible</td> </tr> <tr> <td>12</td> <td>%Rh unit active</td> <td>not_visible(def)</td> <td>visible</td> </tr> <tr> <td>13</td> <td>l/s unit active</td> <td>not_visible(def)</td> <td>visible</td> </tr> <tr> <td>14</td> <td>% unit active</td> <td>not_visible(def)</td> <td>visible</td> </tr> <tr> <td>15</td> <td>h unit active</td> <td>not_visible(def)</td> <td>visible</td> </tr> </table>	3	SecondPointActive	Not decimal(def)	Decimal(def)	4	ThirdPointActive	Not decimal(def)	Decimal(def)	6	C unit active	not_visible(def)	visible	7	F unit active	not_visible(def)	visible	8	Pa unit active	not_visible(def)	visible	9	Lx unit active	not_visible(def)	visible	10	ppm unit active	not_visible(def)	visible	11	m3/h unit active	not_visible(def)	visible	12	%Rh unit active	not_visible(def)	visible	13	l/s unit active	not_visible(def)	visible	14	% unit active	not_visible(def)	visible	15	h unit active	not_visible(def)	visible
3	SecondPointActive	Not decimal(def)	Decimal(def)																																																		
4	ThirdPointActive	Not decimal(def)	Decimal(def)																																																		
6	C unit active	not_visible(def)	visible																																																		
7	F unit active	not_visible(def)	visible																																																		
8	Pa unit active	not_visible(def)	visible																																																		
9	Lx unit active	not_visible(def)	visible																																																		
10	ppm unit active	not_visible(def)	visible																																																		
11	m3/h unit active	not_visible(def)	visible																																																		
12	%Rh unit active	not_visible(def)	visible																																																		
13	l/s unit active	not_visible(def)	visible																																																		
14	% unit active	not_visible(def)	visible																																																		
15	h unit active	not_visible(def)	visible																																																		
40068	67	0x43	FANNUMERIC2 PRESENT_VALUE	Read/write Memory	Present value of the parameter.																																																
40666	665	0x299	FANNUMERIC2 NAME (32-bits)	Read/write Memory	Displaying user-defined parameter name. Default name: Num2																																																
40668	667	0x301	FANNUMERIC2 STEP	Read/write Memory	Step of the parameter value change. The default value is 0.																																																

Modbus Address	Decimal Address	Hex Address	Register Name	Access	Description
40669	668	0x302	FANNUMERIC2 LOW_LIMIT	Read/ write Memory	Minimum value of the parameter. The default value is 0.
40670	669	0x303	FANNUMERIC2 HIGH_LIMIT	Read/ write Memory	Maximum value of the parameter. The default value is 0.
40671	670	0x304	FANNUMERIC2 PRIORITY	Read/ write Memory	Priority of the parameter for sequence of display in the submenu.
40672	671	0x305	FANNUMERIC2 CONFIGURATION	Read/ write Memory	See the table in FanNumeric1 Configuration(40510)
40069	68	0x44	FANNUMERIC3 PRESENT_VALUE	Read/ write Memory	Present value of the parameter.
40675	674	0x2A2	FANNUMERIC3 NAME (32-bits)	Read/ write Memory	Displaying user-defined parameter name. Default name: Num2
40677	676	0x2A4	FANNUMERIC3 STEP	Read/ write Memory	Step of the parameter value change. The default value is 0.
40678	677	0x2A5	FANNUMERIC3 LOW_LIMIT	Read/ write Memory	Minimum value of the parameter. The default value is 0.
40679	678	0x2A6	FANNUMERIC3 HIGH_LIMIT	Read/ write Memory	Maximum value of the parameter. The default value is 0.
40680	679	0x2A7	FANNUMERIC3 PRIORITY	Read/ write Memory	Priority of the parameter for sequence of display in the submenu.
40681	680	0x2A8	FANNUMERIC3 CONFIGURATION	Read/ write Memory	See the table in FanNumeric1 Configuration(40510)
40070	69	0x45	FANNUMERIC4 PRESENT_VALUE	Read/ write Memory	Present value of the parameter.
40684	683	0x2AB	FANNUMERIC4 NAME (32-bits)	Read/ write Memory	Displaying user-defined parameter name. Default name: Num2

Modbus Address	Decimal Address	Hex Address	Register Name	Access	Description
40686	685	0x2AD	FANNUMERIC4 STEP	Read/ write Memory	Step of the parameter value change. The default value is 0.
40687	686	0x2AE	FANNUMERIC4 LOW_LIMIT	Read/ write Memory	Minimum value of the parameter. The default value is 0.
40688	687	0x2AF	FANNUMERIC4 HIGH_LIMIT	Read/ write Memory	Maximum value of the parameter. The default value is 0.
40689	688	0x2B0	FANNUMERIC4 PRIORITY	Read/ write Memory	Priority of the parameter for sequence of display in the submenu.
40690	689	0x2B1	FANNUMERIC4 CONFIGURATION	Read/ write Memory	See the table in FanNumeric1Configuration(40510)
40071	70	0x46	FANNUMERIC5 PRESENT_VALUE	Read/ write Memory	Present value of the parameter.
40693	692	0x2B4	FANNUMERIC5 NAME (32-bits)	Read/ write Memory	Displaying user-defined parameter name. Default name: Num2
40695	694	0x2B6	FANNUMERIC5 STEP	Read/ write Memory	Step of the parameter value change. The default value is 0.
40696	695	0x2B7	FANNUMERIC5 LOW_LIMIT	Read/ write Memory	Minimum value of the parameter. The default value is 0.
40697	696	0x2B8	FANNUMERIC5 HIGH_LIMIT	Read/ write Memory	Maximum value of the parameter. The default value is 0.
40698	697	0x2B9	FANNUMERIC5 PRIORITY	Read/ write Memory	Priority of the parameter for sequence of display in the submenu.
40699	698	0x2BA	FANNUMERIC5 CONFIGURATION	Read/ write Memory	See the table in FanNumeric1 Configuration(40510)
40072	71	0x47	FANNUMERIC6 PRESENT_VALUE	Read/ write Memory	Present value of the parameter.

Modbus Address	Decimal Address	Hex Address	Register Name	Access	Description
40702	701	0x2BD	FANNUMERIC6 NAME (32-bits)	Read/ write Memory	Displaying user-defined parameter name. Default name: Num2
40704	703	0x2BF	FANNUMERIC6 STEP	Read/ write Memory	Step of the parameter value change. The default value is 0.
40705	704	0x2C0	FANNUMERIC6 LOW_LIMIT	Read/ write Memory	Minimum value of the parameter. The default value is 0.
40706	705	0x2C1	FANNUMERIC6 HIGH_LIMIT	Read/ write Memory	Maximum value of the parameter. The default value is 0.
40707	706	0x2C2	FANNUMERIC6 PRIORITY	Read/ write Memory	Priority of the parameter for sequence of display in the submenu.
40708	707	0x2C3	FANNUMERIC6 CONFIGURATION	Read/ write Memory	See the table in FanNumeric1 Configuration(40510)
40073	72	0x48	FANNUMERIC7 PRESENT_VALUE	Read/ write Memory	Present value of the parameter.
40711	710	0x2C6	FANNUMERIC7 NAME (32-bits)	Read/ write Memory	Displaying user-defined parameter name. Default name: Num2
40713	712	0x2C8	FANNUMERIC7 STEP	Read/ write Memory	Step of the parameter value change. The default value is 0.
40714	713	0x2C9	FANNUMERIC7 LOW_LIMIT	Read/ write Memory	Minimum value of the parameter. The default value is 0.
40715	714	0x2CA	FANNUMERIC7 HIGH_LIMIT	Read/ write Memory	Maximum value of the parameter. The default value is 0.
40716	715	0x2CB	FANNUMERIC7 PRIORITY	Read/ write Memory	Priority of the parameter for sequence of display in the submenu.
40717	716	0x2CC	FANNUMERIC7 CONFIGURATION	Read/ write Memory	See the table in FanNumeric1 Configuration(40510)

Modbus Address	Decimal Address	Hex Address	Register Name	Access	Description
40074	73	0x49	FANNUMERIC8 PRESENT_VALUE	Read/ write Memory	Present value of the parameter.
40720	719	0x2CF	FANNUMERIC8 NAME (32-bits)	Read/ write Memory	Displaying user-defined parameter name. Default name: Num2
40722	721	0x2D1	FANNUMERIC8 STEP	Read/ write Memory	Step of the parameter value change. The default value is 0.
40723	722	0x2D2	FANNUMERIC8 LOW_LIMIT	Read/ write Memory	Minimum value of the parameter. The default value is 0.
40724	723	0x2D3	FANNUMERIC8 HIGH_LIMIT	Read/ write Memory	Maximum value of the parameter. The default value is 0.
40725	724	0x2D4	FANNUMERIC8 PRIORITY	Read/ write Memory	Priority of the parameter for sequence of display in the submenu.
40726	725	0x2D5	FANNUMERIC8 CONFIGURATION	Read/ write Memory	See the table in FanNumeric1 Configuration(40510)
40109	108	0x6C	FAN_BOOLEAN_ALL PRESENT_VALUES	Read/ write Memory	See the table in 30107 register
40130	129	0x81	FANBOOLEAN1 PRESENT_VALUE	Read/ write Memory	Present value of the parameter..
40729	728	0x2D8	FANBOOLEAN1 NAME (32-bits)	Read/ write Memory	Displaying user-defined parameter name.
40731	730	0x2DA	FANBOOLEAN1 TRUETEXT (32-bits)	Read/ write Memory	Text for the parameter's true value.
40733	732	0x2DC	FANBOOLEAN1 FALSETEXT (32-bits)	Read/ write Memory	Text for the parameter 's false value.
40735	734	0x2DE	FANBOOLEAN1 PRIORITY	Read/ write Memory	Priority of the parameter for sequence of display in the submenu.

Modbus Address	Decimal Address	Hex Address	Register Name	Access	Description												
40736	735	0x2DF	FANBOOLEAN1 CONFIGURATION	Re Read/write Memory	<table border="1"> <thead> <tr> <th>Bit</th> <th>Name</th> <th>0</th> <th>1</th> </tr> </thead> <tbody> <tr> <td>0</td> <td>Active</td> <td>Not active(def)</td> <td>Active</td> </tr> <tr> <td>1</td> <td>Editabile</td> <td>Not editable</td> <td>Editable(def)</td> </tr> </tbody> </table>	Bit	Name	0	1	0	Active	Not active(def)	Active	1	Editabile	Not editable	Editable(def)
Bit	Name	0	1														
0	Active	Not active(def)	Active														
1	Editabile	Not editable	Editable(def)														
40131	130	0x82	FANBOOLEAN2 PRESENT_VALUE	Read/write Memory	Present value of the parameter.												
40739	738	0x2E2	FANBOOLEAN2 NAME (32-bits)	Read/write Memory	Displaying user-defined parameter name.												
40741	740	0x2E4	FANBOOLEAN2 TRUETEXT (32-bits)	Read/write Memory	Text for the parameter's true value.												
40743	742	0x2E6	FANBOOLEAN2 FALSETEXT (32-bits)	Read/write Memory	Text for the parameter 's false value.												
40745	744	0x2E8	FANBOOLEAN2 PRIORITY	Read/write Memory	Priority of the parameter for sequence of display in the submenu.												
40746	745	0x2E9	FANBOOLEAN2 CONFIGURATION	Re Read/write Memory	<table border="1"> <thead> <tr> <th>Bit</th> <th>Name</th> <th>0</th> <th>1</th> </tr> </thead> <tbody> <tr> <td>0</td> <td>Active</td> <td>Not active(def)</td> <td>Active</td> </tr> <tr> <td>1</td> <td>Editabile</td> <td>Not editable</td> <td>Editable(def)</td> </tr> </tbody> </table>	Bit	Name	0	1	0	Active	Not active(def)	Active	1	Editabile	Not editable	Editable(def)
Bit	Name	0	1														
0	Active	Not active(def)	Active														
1	Editabile	Not editable	Editable(def)														
40132	131	0x83	FANBOOLEAN3 PRESENT_VALUE	Read/write Memory	Present value of the parameter.												
40749	748	0x2EC	FANBOOLEAN3 NAME (32-bits)	Read/write Memory	Displaying user-defined parameter name.												

Modbus Address	Decimal Address	Hex Address	Register Name	Access	Description												
40751	750	0x2EE	FANBOOLEAN3 TRUETEXT 32 – BITS)	Read/ write Memory	Text for the parameter's true value.												
40753	752	0x2F0	FANBOOLEAN3 FALSETEXT (32–bits)	Read/ write Memory	Text for the parameter 's false value.												
40755	754	0x2F2	FANBOOLEAN3 PRIORITY	Read/ write Memory	Priority of the parameter for sequence of display in the submenu.												
40756	755	0x2F3	FANBOOLEAN3 CONFIGURATION	Re Read/ write Memory	<table border="1"> <thead> <tr> <th>Bit</th> <th>Name</th> <th>0</th> <th>1</th> </tr> </thead> <tbody> <tr> <td>0</td> <td>Active</td> <td>Not active(def)</td> <td>Active</td> </tr> <tr> <td>1</td> <td>Editabile</td> <td>Not editable</td> <td>Editable(def)</td> </tr> </tbody> </table>	Bit	Name	0	1	0	Active	Not active(def)	Active	1	Editabile	Not editable	Editable(def)
Bit	Name	0	1														
0	Active	Not active(def)	Active														
1	Editabile	Not editable	Editable(def)														
40133	132	0x84	FANBOOLEAN4 PRESENT_VALUE	Read/ write Memory	Present value of the parameter.												
40759	758	0x2F6	FANBOOLEAN4 NAME (32–bits)	Read/ write Memory	Displaying user-defined parameter name.												
40761	760	0x2F8	FANBOOLEAN4 TRUETEXT (32–bits)	Read/ write Memory	Text for the parameter's true value.												
40763	762	0x2FA	FANBOOLEAN4 FALSETEXT (32–bits)	Read/ write Memory	Text for the parameter 's false value.												
40765	764	0x2FC	FANBOOLEAN4 PRIORITY	Read/ write Memory	Priority of the parameter for sequence of display in the submenu.												
40766	765	0x2FD	FANBOOLEAN4 CONFIGURATION	Re Read/ write Memory	<table border="1"> <thead> <tr> <th>Bit</th> <th>Name</th> <th>0</th> <th>1</th> </tr> </thead> <tbody> <tr> <td>0</td> <td>Active</td> <td>Not active(def)</td> <td>Active</td> </tr> </tbody> </table>	Bit	Name	0	1	0	Active	Not active(def)	Active				
Bit	Name	0	1														
0	Active	Not active(def)	Active														



Modbus Address	Decimal Address	Hex Address	Register Name	Access	Description			
					1	Editabile	Not editable	Editable(def)
40134	133	0x85	FANBOOLEAN5 PRESENT_VALUE	Read/write Memory	Present value of the parameter.			
40769	768	0x300	FANBOOLEAN5 NAME (32-bits)	Read/write Memory	Displaying user-defined parameter name.			
40771	770	0x302	FANBOOLEAN5 TRUETEXT (32-bits)	Read/write Memory	Text for the parameter's true value.			
40773	772	0x304	FANBOOLEAN5 FALSETEXT (32-bits)	Read/write Memory	Text for the parameter 's false value.			
40775	774	0x306	FANBOOLEAN5 PRIORITY	Read/write Memory	Priority of the parameter for sequence of display in the submenu.			
40776	775	0x307	FANBOOLEAN5 CONFIGURATION	Re Read/write Memory	Bit	Name	0	1
					0	Active	Not active(def)	Active
					1	Editabile	Not editable	Editable(def)
40135	134	0x86	FANBOOLEAN6 PRESENT_VALUE	Read/write Memory	Present value of the parameter.			
40779	778	0x30A	FANBOOLEAN6 NAME (32-bits)	Read/write Memory	Displaying user-defined parameter name.			
40781	780	0x30C	FANBOOLEAN6 TRUETEXT (32-bits)	Read/write Memory	Text for the parameter's true value.			
40783	782	0x30E	FANBOOLEAN6 FALSETEXT (32-bits)	Read/write Memory	Text for the parameter 's false value.			

Modbus Address	Decimal Address	Hex Address	Register Name	Access	Description												
40785	784	0x310	FANBOOLEAN6 PRIORITY	Read/ write Memory	Priority of the parameter for sequence of display in the submenu.												
40786	785	0x311	FANBOOLEAN6 CONFIGURATION	Read/ write Memory	<table border="1"> <thead> <tr> <th>Bit</th> <th>Name</th> <th>0</th> <th>1</th> </tr> </thead> <tbody> <tr> <td>0</td> <td>Active</td> <td>Not active(def)</td> <td>Active</td> </tr> <tr> <td>1</td> <td>Editabile</td> <td>Not editable</td> <td>Editable(def)</td> </tr> </tbody> </table>	Bit	Name	0	1	0	Active	Not active(def)	Active	1	Editabile	Not editable	Editable(def)
Bit	Name	0	1														
0	Active	Not active(def)	Active														
1	Editabile	Not editable	Editable(def)														
40136	135	0x87	FANBOOLEAN7 PRESENT_VALUE	Read/ write Memory	Present value of the parameter.												
40789	788	0x314	FANBOOLEAN7 NAME (32-bits)	Read/ write Memory	Displaying user-defined parameter name.												
40791	790	0x316	FANBOOLEAN7 TRUETEXT (32-bits)	Read/ write Memory	Text for the parameter's true value.												
40793	792	0x318	FANBOOLEAN7 FALSETEXT (32-bits)	Read/ write Memory	Text for the parameter's false value.												
40795	794	0x31A	FANBOOLEAN7 PRIORITY	Read/ write Memory	Priority of the parameter for sequence of display in the submenu.												
40796	795	0x31B	FANBOOLEAN7 CONFIGURATION	Read/ write Memory	<table border="1"> <thead> <tr> <th>Bit</th> <th>Name</th> <th>0</th> <th>1</th> </tr> </thead> <tbody> <tr> <td>0</td> <td>Active</td> <td>Not active(def)</td> <td>Active</td> </tr> <tr> <td>1</td> <td>Editabile</td> <td>Not editable</td> <td>Editable(def)</td> </tr> </tbody> </table>	Bit	Name	0	1	0	Active	Not active(def)	Active	1	Editabile	Not editable	Editable(def)
Bit	Name	0	1														
0	Active	Not active(def)	Active														
1	Editabile	Not editable	Editable(def)														
40137	136	0x88	FANBOOLEAN8 PRESENT_VALUE	Read/ write Memory	Present value of the parameter.												

Modbus Address	Decimal Address	Hex Address	Register Name	Access	Description												
40799	798	0x31E	FANBOOLEAN8 NAME (32-bits)	Read/ write Memory	Displaying user-defined parameter name.												
40648	800	0x320	FANBOOLEAN8 TRUETEXT (32-bits)	Read/ write Memory	Text for the parameter's true value.												
40803	802	0x322	FANBOOLEAN8 FALSETEXT (32-bits)	Read/ write Memory	Text for the parameter 's false value.												
40805	804	0x324	FANBOOLEAN8 PRIORITY	Read/ write Memory	Priority of the parameter for sequence of display in the submenu.												
40806	805	0x325	FANBOOLEAN8 CONFIGURATION	Read/ write Memory	<table border="1"> <thead> <tr> <th>Bit</th> <th>Name</th> <th>0</th> <th>1</th> </tr> </thead> <tbody> <tr> <td>0</td> <td>Active</td> <td>Not active(def)</td> <td>Active</td> </tr> <tr> <td>1</td> <td>Editabile</td> <td>Not editable</td> <td>Editable(def)</td> </tr> </tbody> </table>	Bit	Name	0	1	0	Active	Not active(def)	Active	1	Editabile	Not editable	Editable(def)
Bit	Name	0	1														
0	Active	Not active(def)	Active														
1	Editabile	Not editable	Editable(def)														

Table 41. List of fan submenu registers

### 13.1.4 Light Submenu Registers

Modbus Address	Decimal Address	Hex Address	Register Name	Access	Description
40075	74	0x4A	LIGHTNUMERIC1 PRESENT_VALUE	Read/ write Memory	Present value of the parameter.
40807	806	0x326	LIGHT_MENU_ACTIVE_POINTS	Read/ write Memory	Number of active parameters in the submenu.
40810	809	0x329	LIGHTNUMERIC1 NAME (32-bits)	Read/ write Memory	Displaying user-defined parameter name.
40812	811	0x32B	LIGHTNUMERIC1 STEP	Read/ write Memory	Step of the parameter value change. The default value is 0.

Modbus Address	Decimal Address	Hex Address	Register Name	Access	Description																																												
40813	812	0x32C	LIGHTNUMERIC1 LOW_LIMIT	Read/ write Memory	Minimum value of the parameter. The default value is 0.																																												
40814	813	0x32D	LIGHTNUMERIC1 HIGH_LIMIT	Read/ write Memory	Maximum value of the parameter. The default value is 0.																																												
40815	814	0x32E	LIGHTNUMERIC1 PRIORITY	Read/ write Memory	Priority of the parameter for sequence of display in the submenu.																																												
40816	815	0x32F	LIGHTNUMERIC1 CONFIGURATION	Read/ write Memory	<table border="1"> <thead> <tr> <th>Bit</th> <th>Name</th> <th>0</th> <th>1</th> </tr> </thead> <tbody> <tr> <td>0</td> <td>Active</td> <td>Not active(def)</td> <td>Active(def)</td> </tr> <tr> <td>2</td> <td>FirstPointActive</td> <td>Not decimal(def)</td> <td>Decimal(def)</td> </tr> <tr> <td>3</td> <td>SecondPointActive</td> <td>Not decimal(def)</td> <td>Decimal(def)</td> </tr> <tr> <td>4</td> <td>ThirdPointActive</td> <td>Not decimal(def)</td> <td>Decimal(def)</td> </tr> <tr> <td>6</td> <td>C unit active</td> <td>not_visible(def)</td> <td>visible</td> </tr> <tr> <td>7</td> <td>F unit active</td> <td>not_visible(def)</td> <td>visible</td> </tr> <tr> <td>8</td> <td>Pa unit active</td> <td>not_visible(def)</td> <td>visible</td> </tr> <tr> <td>9</td> <td>Lx unit active</td> <td>not_visible(def)</td> <td>visible</td> </tr> <tr> <td>10</td> <td>ppm unit active</td> <td>not_visible(def)</td> <td>visible</td> </tr> <tr> <td>11</td> <td>m3/h unit active</td> <td>not_visible(def)</td> <td>visible</td> </tr> </tbody> </table>	Bit	Name	0	1	0	Active	Not active(def)	Active(def)	2	FirstPointActive	Not decimal(def)	Decimal(def)	3	SecondPointActive	Not decimal(def)	Decimal(def)	4	ThirdPointActive	Not decimal(def)	Decimal(def)	6	C unit active	not_visible(def)	visible	7	F unit active	not_visible(def)	visible	8	Pa unit active	not_visible(def)	visible	9	Lx unit active	not_visible(def)	visible	10	ppm unit active	not_visible(def)	visible	11	m3/h unit active	not_visible(def)	visible
Bit	Name	0	1																																														
0	Active	Not active(def)	Active(def)																																														
2	FirstPointActive	Not decimal(def)	Decimal(def)																																														
3	SecondPointActive	Not decimal(def)	Decimal(def)																																														
4	ThirdPointActive	Not decimal(def)	Decimal(def)																																														
6	C unit active	not_visible(def)	visible																																														
7	F unit active	not_visible(def)	visible																																														
8	Pa unit active	not_visible(def)	visible																																														
9	Lx unit active	not_visible(def)	visible																																														
10	ppm unit active	not_visible(def)	visible																																														
11	m3/h unit active	not_visible(def)	visible																																														

Modbus Address	Decimal Address	Hex Address	Register Name	Access	Description																																
					<table border="1"> <tr> <td>1</td> <td>%Rh unit</td> <td>not_visible(def)</td> <td>visible</td> </tr> <tr> <td>2</td> <td>active</td> <td></td> <td></td> </tr> <tr> <td>1</td> <td>l/s unit</td> <td>not_visible(def)</td> <td>visible</td> </tr> <tr> <td>3</td> <td>active</td> <td></td> <td></td> </tr> <tr> <td>1</td> <td>% unit</td> <td>not_visible(def)</td> <td>visible</td> </tr> <tr> <td>4</td> <td>active</td> <td></td> <td></td> </tr> <tr> <td>1</td> <td>h unit</td> <td>not_visible(def)</td> <td>visible</td> </tr> <tr> <td>5</td> <td>active</td> <td></td> <td></td> </tr> </table>	1	%Rh unit	not_visible(def)	visible	2	active			1	l/s unit	not_visible(def)	visible	3	active			1	% unit	not_visible(def)	visible	4	active			1	h unit	not_visible(def)	visible	5	active		
1	%Rh unit	not_visible(def)	visible																																		
2	active																																				
1	l/s unit	not_visible(def)	visible																																		
3	active																																				
1	% unit	not_visible(def)	visible																																		
4	active																																				
1	h unit	not_visible(def)	visible																																		
5	active																																				
40076	75	0x4B	LIGHTNUMERIC2 PRESENT_VALUE	Read/write Memory	Present value of the parameter.																																
40819	818	0x332	LIGHTNUMERIC2 NAME (32-bits)	Read/write Memory	Displaying user-defined parameter name. Default name: Num2																																
40821	820	0x334	LIGHTNUMERIC2 STEP	Read/write Memory	Step of the parameter value change. The default value is 0.																																
40822	821	0x335	LIGHTNUMERIC2 LOW_LIMIT	Read/write Memory	Minimum value of the parameter. The default value is 0.																																
40823	822	0x336	LIGHTNUMERIC2 HIGH_LIMIT	Read/write Memory	Maximum value of the parameter. The default value is 0.																																
40824	823	0x337	LIGHTNUMERIC2 PRIORITY	Read/write Memory	Priority of the parameter for sequence of display in the submenu.																																
40825	824	0x338	LIGHTNUMERIC2 CONFIGURATION	Read/write Memory	See the table in LightNumeric1Configuration(40510)																																
40077	76	0x4C	LIGHTNUMERIC3 PRESENT_VALUE	Read/write Memory	Present value of the parameter.																																
40828	827	0x33B	LIGHTNUMERIC3 NAME (32-bits)	Read/write Memory	Displaying user-defined parameter name. Default name: Num2																																
40830	829	0x33D	LIGHTNUMERIC3 STEP	Read/write Memory	Step of the parameter value change. The default value is 0.																																

Modbus Address	Decimal Address	Hex Address	Register Name	Access	Description
40831	830	0x33E	LIGHTNUMERIC3 LOW_LIMIT	Read/ write Memory	Minimum value of the parameter. The default value is 0.
40832	831	0x33F	LIGHTNUMERIC3 HIGH_LIMIT	Read/ write Memory	Maximum value of the parameter. The default value is 0.
40833	832	0x340	LIGHTNUMERIC3 PRIORITY	Read/ write Memory	Priority of the parameter for sequence of display in the submenu.
40834	833	0x341	LIGHTNUMERIC3 CONFIGURATION	Read/ write Memory	See the table in LightNumeric1Configuration(40510)
40078	77	0x4D	LIGHTNUMERIC4 PRESENT_VALUE	Read/ write Memory	Present value of the parameter.
40837	836	0x344	LIGHTNUMERIC4 NAME (32-bits)	Read/ write Memory	Displaying user-defined parameter name. Default name: Num2
40839	838	0x346	LIGHTNUMERIC4 STEP	Read/ write Memory	Step of the parameter value change. The default value is 0.
40840	839	0x347	LIGHTNUMERIC4 LOW_LIMIT	Read/ write Memory	Minimum value of the parameter. The default value is 0.
40841	840	0x348	LIGHTNUMERIC4 HIGH_LIMIT	Read/ write Memory	Maximum value of the parameter. The default value is 0.
40842	841	0x349	LIGHTNUMERIC4 PRIORITY	Read/ write Memory	Priority of the parameter for sequence of display in the submenu.
40843	842	0x34A	LIGHTNUMERIC4 CONFIGURATION	Read/ write Memory	See the table in LightNumeric1Configuration(40510)
40079	78	0x4E	LIGHTNUMERIC5 PRESENT_VALUE	Read/ write Memory	Present value of the parameter.
40846	845	0x34D	LIGHTNUMERIC5 NAME (32-bits)	Read/ write Memory	Displaying user-defined parameter name. Default name: Num2

Modbus Address	Decimal Address	Hex Address	Register Name	Access	Description
40848	847	0x34F	LIGHTNUMERIC5 STEP	Read/ write Memory	Step of the parameter value change. The default value is 0.
40849	848	0x350	LIGHTNUMERIC5 LOW_LIMIT	Read/ write Memory	Minimum value of the parameter. The default value is 0.
40850	849	0x351	LIGHTNUMERIC5 HIGH_LIMIT	Read/ write Memory	Maximum value of the parameter. The default value is 0.
40851	850	0x352	LIGHTNUMERIC5 PRIORITY	Read/ write Memory	Priority of the parameter for sequence of display in the submenu.
40852	851	0x353	LIGHTNUMERIC5 CONFIGURATION	Read/ write Memory	See the table in LightNumeric1Configuration(40510)
40080	79	0x4F	LIGHTNUMERIC6 PRESENT_VALUE	Read/ write Memory	Present value of the parameter.
40855	854	0x356	LIGHTNUMERIC6 NAME (32-bits)	Read/ write Memory	Displaying user-defined parameter name. Default name: Num2
40857	856	0x358	LIGHTNUMERIC6 STEP	Read/ write Memory	Step of the parameter value change. The default value is 0.
40858	857	0x359	LIGHTNUMERIC6 LOW_LIMIT	Read/ write Memory	Minimum value of the parameter. The default value is 0.
40859	858	0x35A	LIGHTNUMERIC6 HIGH_LIMIT	Read/ write Memory	Maximum value of the parameter. The default value is 0.
40860	859	0x35B	LIGHTNUMERIC6 PRIORITY	Read/ write Memory	Priority of the parameter for sequence of display in the submenu.
40861	860	0x35C	LIGHTNUMERIC6 CONFIGURATION	Read/ write Memory	See the table in LightNumeric1Configuration(40510)
40081	80	0x50	LIGHTNUMERIC7 PRESENT_VALUE	Read/ write Memory	Present value of the parameter.

Modbus Address	Decimal Address	Hex Address	Register Name	Access	Description
40864	863	0x35F	LIGHTNUMERIC7 NAME (32-bits)	Read/ write Memory	Displaying user-defined parameter name. Default name: Num2
40866	865	0x361	LIGHTNUMERIC7 STEP	Read/ write Memory	Step of the parameter value change. The default value is 0.
40867	866	0x362	LIGHTNUMERIC7 LOW_LIMIT	Read/ write Memory	Minimum value of the parameter. The default value is 0.
40868	867	0x363	LIGHTNUMERIC7 HIGH_LIMIT	Read/ write Memory	Maximum value of the parameter. The default value is 0.
40869	868	0x364	LIGHTNUMERIC7 PRIORITY	Read/ write Memory	Priority of the parameter for sequence of display in the submenu.
40870	869	0x365	LIGHTNUMERIC7 CONFIGURATION	Read/ write Memory	See the table in LightNumeric1Configuration(40510)
40082	81	0x51	LIGHTNUMERIC8 PRESENT_VALUE	Read/ write Memory	Present value of the parameter.
40873	872	0x368	LIGHTNUMERIC8 NAME (32-bits)	Read/ write Memory	Displaying user-defined parameter name. Default name: Num2
40875	874	0x36A	LIGHTNUMERIC8 STEP	Read/ write Memory	Step of the parameter value change. The default value is 0.
40876	875	0x36B	LIGHTNUMERIC8 LOW_LIMIT	Read/ write Memory	Minimum value of the parameter. The default value is 0.
40877	876	0x36C	LIGHTNUMERIC8 HIGH_LIMIT	Read/ write Memory	Maximum value of the parameter. The default value is 0.
40878	877	0x36D	LIGHTNUMERIC8 PRIORITY	Read/ write Memory	Priority of the parameter for sequence of display in the submenu.
40879	878	0x36E	LIGHTNUMERIC8 CONFIGURATION	Read/ write Memory	See the table in LightNumeric1Configuration(40510)



Modbus Address	Decimal Address	Hex Address	Register Name	Access	Description												
40110	109	0x6D	LIGHTBOOLEANALL PRESENT_VALUES	Read/ write Memory	See the table in 30107 register.												
40138	137	0x89	LIGHTBOOLEAN1 PRESENT_VALUE	Read/ write Memory	Present value of the parameter.												
40882	881	0x371	LIGHTBOOLEAN1 NAME (32-bits)	Read/ write Memory	Displaying user-defined parameter name.												
40884	883	0x373	LIGHTBOOLEAN1 TRUETEXT (32-bits)	Read/ write Memory	Text for the parameter's true value.												
40886	885	0x375	LIGHTBOOLEAN1 FALSETEXT (32-bits)	Read/ write Memory	Text for the parameter 's false value.												
40888	887	0x377	LIGHTBOOLEAN1 PRIORITY	Read/ write Memory	Priority of the parameter for sequence of display in the submenu.												
40889	888	0x378	LIGHTBOOLEAN1 CONFIGURATION	Read/ write Memory	<table border="1"> <thead> <tr> <th>Bit</th> <th>Name</th> <th>0</th> <th>1</th> </tr> </thead> <tbody> <tr> <td>0</td> <td>Active</td> <td>Not active(def)</td> <td>Active</td> </tr> <tr> <td>1</td> <td>Editable</td> <td>Not editable</td> <td>Editable(def)</td> </tr> </tbody> </table>	Bit	Name	0	1	0	Active	Not active(def)	Active	1	Editable	Not editable	Editable(def)
Bit	Name	0	1														
0	Active	Not active(def)	Active														
1	Editable	Not editable	Editable(def)														
40139	138	0x8A	LIGHTBOOLEAN2 PRESENT_VALUE	Read/ write Memory	Present value of the parameter.												
40892	891	0x37B	LIGHTBOOLEAN2 NAME (32-bits)	Read/ write Memory	Displaying user-defined parameter name.												
40894	893	0x37D	LIGHTBOOLEAN2 TRUETEXT (32-bits)	Read/ write Memory	Text for the parameter's true value.												
40896	895	0x37F	LIGHTBOOLEAN2 FALSETEXT (32-bits)	Read/ write Memory	Text for the parameter 's false value.												

Modbus Address	Decimal Address	Hex Address	Register Name	Access	Description												
40898	897	0x381	LIGHTBOOLEAN2 PRIORITY	Read/ write Memory	Priority of the parameter for sequence of display in the submenu.												
40899	898	0x382	LIGHTBOOLEAN2 CONFIGURATION	Re Read/ write Memory	<table border="1"> <thead> <tr> <th>Bit</th> <th>Name</th> <th>0</th> <th>1</th> </tr> </thead> <tbody> <tr> <td>0</td> <td>Active</td> <td>Not active(def)</td> <td>Active</td> </tr> <tr> <td>1</td> <td>Editabile</td> <td>Not editable</td> <td>Editable(def)</td> </tr> </tbody> </table>	Bit	Name	0	1	0	Active	Not active(def)	Active	1	Editabile	Not editable	Editable(def)
Bit	Name	0	1														
0	Active	Not active(def)	Active														
1	Editabile	Not editable	Editable(def)														
40140	139	0x8B	LIGHTBOOLEAN3 PRESENT_VALUE	Read/ write Memory	Present value of the parameter.												
40902	901	0x385	LIGHTBOOLEAN3 NAME (32-bits)	Read/ write Memory	Displaying userdefined parameter name.												
40904	903	0x387	LIGHTBOOLEAN3 TRUETEXT (32-bits)	Read/ write Memory	Text for the parameter's true value.												
40906	905	0x389	LIGHTBOOLEAN3 FALSETEXT (32-bits)	Read/ write Memory	Text for the parameter 's false value.												
40908	907	0x38B	LIGHTBOOLEAN3 PRIORITY	Read/ write Memory	Priority of the parameter for sequence of display in the submenu.												
40909	908	0x38C	LIGHTBOOLEAN3 CONFIGURATION	Re Read/ write Memory	<table border="1"> <thead> <tr> <th>Bit</th> <th>Name</th> <th>0</th> <th>1</th> </tr> </thead> <tbody> <tr> <td>0</td> <td>Active</td> <td>Not active(def)</td> <td>Active</td> </tr> <tr> <td>1</td> <td>Editabile</td> <td>Not editable</td> <td>Editable(def)</td> </tr> </tbody> </table>	Bit	Name	0	1	0	Active	Not active(def)	Active	1	Editabile	Not editable	Editable(def)
Bit	Name	0	1														
0	Active	Not active(def)	Active														
1	Editabile	Not editable	Editable(def)														
40141	140	0x8C	LIGHTBOOLEAN4 PRESENT_VALUE	Read/ write Memory	Present value of the parameter.												

Modbus Address	Decimal Address	Hex Address	Register Name	Access	Description												
40912	911	0x38F	LIGHTBOOLEAN4 NAME (32-bits)	Read/ write Memory	Displaying user-defined parameter name.												
40914	913	0x391	LIGHTBOOLEAN4 TRUETEXT (32-bits)	Read/ write Memory	Text for the parameter's true value.												
40916	915	0x393	LIGHTBOOLEAN4 FALSETEXT (32-bits)	Read/ write Memory	Text for the parameter 's false value.												
40918	917	0x395	LIGHTBOOLEAN4 PRIORITY	Read/ write Memory	Priority of the parameter for sequence of display in the submenu.												
40919	918	0x396	LIGHTBOOLEAN4 CONFIGURATION	Re Read/ write Memory	<table border="1"> <thead> <tr> <th>Bit</th> <th>Name</th> <th>0</th> <th>1</th> </tr> </thead> <tbody> <tr> <td>0</td> <td>Active</td> <td>Not active(def)</td> <td>Active</td> </tr> <tr> <td>1</td> <td>Editabile</td> <td>Not editable</td> <td>Editable(def)</td> </tr> </tbody> </table>	Bit	Name	0	1	0	Active	Not active(def)	Active	1	Editabile	Not editable	Editable(def)
Bit	Name	0	1														
0	Active	Not active(def)	Active														
1	Editabile	Not editable	Editable(def)														
40142	141	0x8D	LIGHTBOOLEAN5 PRESENT_VALUE	Read/ write Memory	Present value of the parameter.												
40922	921	0x399	LIGHTBOOLEAN5 NAME (32-bits)	Read/ write Memory	Displaying user-defined parameter name.												
40924	923	0x39B	LIGHTBOOLEAN5 TRUETEXT (32-bits)	Read/ write Memory	Text for the parameter's true value.												
40926	925	0x39D	LIGHTBOOLEAN5 FALSETEXT (32-bits)	Read/ write Memory	Text for the parameter 's false value.												
40928	927	0x39F	LIGHTBOOLEAN5 PRIORITY	Read/ write Memory	Priority of the parameter for sequence of display in the submenu.												
40929	928	0x3A0	LIGHTBOOLEAN5 CONFIGURATION	Re Read/ write Memory	<table border="1"> <thead> <tr> <th>Bit</th> <th>Name</th> <th>0</th> <th>1</th> </tr> </thead> <tbody> <tr> <td></td> <td></td> <td></td> <td></td> </tr> </tbody> </table>	Bit	Name	0	1								
Bit	Name	0	1														

Modbus Address	Decimal Address	Hex Address	Register Name	Access	Description												
					<table border="1"> <tr> <td>0</td> <td>Active</td> <td>Not active(def)</td> <td>Active</td> </tr> <tr> <td>1</td> <td>Editable</td> <td>Not editable</td> <td>Editable(def)</td> </tr> </table>	0	Active	Not active(def)	Active	1	Editable	Not editable	Editable(def)				
0	Active	Not active(def)	Active														
1	Editable	Not editable	Editable(def)														
40143	142	0x8E	LIGHTBOOLEAN6 PRESENT_VALUE	Read/write Memory	Present value of the parameter.												
40932	931	0x3A3	LIGHTBOOLEAN6 NAME (32-bits)	Read/write Memory	Displaying user-defined parameter name.												
40934	933	0x3A5	LIGHTBOOLEAN6 TRUETEXT (32-bits)	Read/write Memory	Text for the parameter's true value.												
40936	935	0x3A7	LIGHTBOOLEAN6 FALSETEXT (32-bits)	Read/write Memory	Text for the parameter's false value.												
40938	937	0x3A9	LIGHTBOOLEAN6 PRIORITY	Read/write Memory	Priority of the parameter for sequence of display in the submenu.												
40939	938	0x3AA	LIGHTBOOLEAN6 CONFIGURATION	Read/write Memory	<table border="1"> <tr> <td>Bit</td> <td>Name</td> <td>0</td> <td>1</td> </tr> <tr> <td>0</td> <td>Active</td> <td>Not active(def)</td> <td>Active</td> </tr> <tr> <td>1</td> <td>Editable</td> <td>Not editable</td> <td>Editable(def)</td> </tr> </table>	Bit	Name	0	1	0	Active	Not active(def)	Active	1	Editable	Not editable	Editable(def)
Bit	Name	0	1														
0	Active	Not active(def)	Active														
1	Editable	Not editable	Editable(def)														
40144	143	0x8F	LIGHTBOOLEAN7 PRESENT_VALUE	Read/write Memory	Present value of the parameter.												
40942	941	0x3AD	LIGHTBOOLEAN7 NAME (32-bits)	Read/write Memory	Displaying user-defined parameter name.												
40944	943	0x3AF	LIGHTBOOLEAN7 TRUETEXT (32-bits)	Read/write Memory	Text for the parameter's true value.												

Modbus Address	Decimal Address	Hex Address	Register Name	Access	Description												
40946	945	0x3B1	LIGHTBOOLEAN7 FALSETEXT (32-bits)	Read/ write Memory	Text for the parameter 's false value.												
40948	947	0x3B3	LIGHTBOOLEAN7 PRIORITY	Read/ write Memory	Priority of the parameter for sequence of display in the submenu.												
40949	948	0x3B4	LIGHTBOOLEAN7 CONFIGURATION	Read/ write Memory	<table border="1"> <thead> <tr> <th>Bit</th> <th>Name</th> <th>0</th> <th>1</th> </tr> </thead> <tbody> <tr> <td>0</td> <td>Active</td> <td>Not active(def)</td> <td>Active</td> </tr> <tr> <td>1</td> <td>Editabile</td> <td>Not editable</td> <td>Editable(def)</td> </tr> </tbody> </table>	Bit	Name	0	1	0	Active	Not active(def)	Active	1	Editabile	Not editable	Editable(def)
Bit	Name	0	1														
0	Active	Not active(def)	Active														
1	Editabile	Not editable	Editable(def)														
40145	144	0x90	LIGHTBOOLEAN8 PRESENT_VALUE	Read/ write Memory	Present value of the parameter.												
40952	951	0x3B7	LIGHTBOOLEAN8 NAME (32-bits)	Read/ write Memory	Displaying user-defined parameter name.												
40954	953	0x3B9	LIGHTBOOLEAN8 TRUETEXT (32-bits)	Read/ write Memory	Text for the parameter's true value.												
40956	955	0x3BB	LIGHTBOOLEAN8 FALSETEXT (32-bits)	Read/ write Memory	Text for the parameter 's false value.												
40958	957	0x3BD	LIGHTBOOLEAN8 PRIORITY	Read/ write Memory	Priority of the parameter for sequence of display in the submenu.												
40959	958	0x3BE	LIGHTBOOLEAN8 CONFIGURATION	Read/ write Memory	<table border="1"> <thead> <tr> <th>Bit</th> <th>Name</th> <th>0</th> <th>1</th> </tr> </thead> <tbody> <tr> <td>0</td> <td>Active</td> <td>Not active(def)</td> <td>Active</td> </tr> <tr> <td>1</td> <td>Editabile</td> <td>Not editable</td> <td>Editable(def)</td> </tr> </tbody> </table>	Bit	Name	0	1	0	Active	Not active(def)	Active	1	Editabile	Not editable	Editable(def)
Bit	Name	0	1														
0	Active	Not active(def)	Active														
1	Editabile	Not editable	Editable(def)														

Table 42. List of light submenu registers

### 13.1.5 Blind Submenu Registers

Modbus Address	Decimal Address	Hex Address	Register Name	Access	Description																								
40083	82	0x52	BLINDNUMERIC1 PRESENT_VALUE	Read/ write Memory	Present value of the parameter.																								
40960	959	0x3BF	BLIND_MENU ACTIVE_POINTS	Read/ write Memory	Number of active parameters in the submenu.																								
40963	962	0x3C2	BLINDNUMERIC1 NAME (32-bits)	Read/ write Memory	Displaying user-defined parameter name.																								
40965	964	0x3C4	BLINDNUMERIC1 STEP	Read/ write Memory	Step of the parameter value change. The default value is 0.																								
40966	965	0x3C5	BLINDNUMERIC1 LOW_LIMIT	Read/ write Memory	Minimum value of the parameter. The default value is 0.																								
40967	966	0x3C6	BLINDNUMERIC1 HIGH_LIMIT	Read/ write Memory	Maximum value of the parameter. The default value is 0.																								
40968	967	0x3C7	BLINDNUMERIC1 PRIORITY	Read/ write Memory	Priority of the parameter for sequence of display in the submenu.																								
40969	968	0x3C8	BLINDNUMERIC1 CONFIGURATION	Read/ write Memory	<table border="1"> <thead> <tr> <th>Bit</th> <th>Name</th> <th>0</th> <th>1</th> </tr> </thead> <tbody> <tr> <td>0</td> <td>Active</td> <td>Not active(def)</td> <td>Active(def)</td> </tr> <tr> <td>2</td> <td>FirstPointActive</td> <td>Not decimal(def)</td> <td>Decimal(def)</td> </tr> <tr> <td>3</td> <td>SecondPointActive</td> <td>Not decimal(def)</td> <td>Decimal(def)</td> </tr> <tr> <td>4</td> <td>ThirdPointActive</td> <td>Not decimal(def)</td> <td>Decimal(def)</td> </tr> <tr> <td>6</td> <td>C unit active</td> <td>not_visible(def)</td> <td>visible</td> </tr> </tbody> </table>	Bit	Name	0	1	0	Active	Not active(def)	Active(def)	2	FirstPointActive	Not decimal(def)	Decimal(def)	3	SecondPointActive	Not decimal(def)	Decimal(def)	4	ThirdPointActive	Not decimal(def)	Decimal(def)	6	C unit active	not_visible(def)	visible
Bit	Name	0	1																										
0	Active	Not active(def)	Active(def)																										
2	FirstPointActive	Not decimal(def)	Decimal(def)																										
3	SecondPointActive	Not decimal(def)	Decimal(def)																										
4	ThirdPointActive	Not decimal(def)	Decimal(def)																										
6	C unit active	not_visible(def)	visible																										

Modbus Address	Decimal Address	Hex Address	Register Name	Access	Description																																				
					<table border="1"> <tr> <td>7</td> <td>F unit active</td> <td>not_visible(def)</td> <td>visible</td> </tr> <tr> <td>8</td> <td>Pa unit active</td> <td>not_visible(def)</td> <td>visible</td> </tr> <tr> <td>9</td> <td>Lx unit active</td> <td>not_visible(def)</td> <td>visible</td> </tr> <tr> <td>10</td> <td>ppm unit active</td> <td>not_visible(def)</td> <td>visible</td> </tr> <tr> <td>11</td> <td>m3/h unit active</td> <td>not_visible(def)</td> <td>visible</td> </tr> <tr> <td>12</td> <td>%Rh unit active</td> <td>not_visible(def)</td> <td>visible</td> </tr> <tr> <td>13</td> <td>l/s unit active</td> <td>not_visible(def)</td> <td>visible</td> </tr> <tr> <td>14</td> <td>% unit active</td> <td>not_visible(def)</td> <td>visible</td> </tr> <tr> <td>15</td> <td>h unit active</td> <td>not_visible(def)</td> <td>visible</td> </tr> </table>	7	F unit active	not_visible(def)	visible	8	Pa unit active	not_visible(def)	visible	9	Lx unit active	not_visible(def)	visible	10	ppm unit active	not_visible(def)	visible	11	m3/h unit active	not_visible(def)	visible	12	%Rh unit active	not_visible(def)	visible	13	l/s unit active	not_visible(def)	visible	14	% unit active	not_visible(def)	visible	15	h unit active	not_visible(def)	visible
7	F unit active	not_visible(def)	visible																																						
8	Pa unit active	not_visible(def)	visible																																						
9	Lx unit active	not_visible(def)	visible																																						
10	ppm unit active	not_visible(def)	visible																																						
11	m3/h unit active	not_visible(def)	visible																																						
12	%Rh unit active	not_visible(def)	visible																																						
13	l/s unit active	not_visible(def)	visible																																						
14	% unit active	not_visible(def)	visible																																						
15	h unit active	not_visible(def)	visible																																						
40084	83	0x53	BLINDNUMERIC2 PRESENT_VALUE	Read/write Memory	Present value of the parameter.																																				
40972	971	0x3CB	BLINDNUMERIC2 NAME (32-bits)	Read/write Memory	Displaying user-defined parameter name. Default name: Num2																																				
40974	973	0x3CD	BLINDNUMERIC2 STEP	Read/write Memory	Step of the parameter value change. The default value is 0.																																				
40975	974	0x3CE	BLINDNUMERIC2 LOW_LIMIT	Read/write Memory	Minimum value of the parameter. The default value is 0.																																				
40976	975	0x3CF	BLINDNUMERIC2 HIGH_LIMIT	Read/write Memory	Maximum value of the parameter. The default value is 0.																																				
40977	976	0x3D0	BLINDNUMERIC2 PRIORITY	Read/write Memory	Priority of the parameter for sequence of display in the submenu.																																				

Modbus Address	Decimal Address	Hex Address	Register Name	Access	Description
40978	977	0x3D1	BLINDNUMERIC2 CONFIGURATION	Read/ write Memory	See the table in BlindNumeric1Configuration(40510)
40085	84	0x54	BLINDNUMERIC3 PRESENT_VALUE	Read/ write Memory	Present value of the parameter.
40981	980	0x3D4	BLINDNUMERIC3 NAME (32-bits)	Read/ write Memory	Displaying user-defined parameter name. Default name: Num2
40983	982	0x3D6	BLINDNUMERIC3 STEP	Read/ write Memory	Step of the parameter value change. The default value is 0.
40984	983	0x3D7	BLINDNUMERIC3 LOW_LIMIT	Read/ write Memory	Minimum value of the parameter. The default value is 0.
40985	984	0x3D8	BLINDNUMERIC3 HIGH_LIMIT	Read/ write Memory	Maximum value of the parameter. The default value is 0.
40986	985	0x3D9	BLINDNUMERIC3 PRIORITY	Read/ write Memory	Priority of the parameter for sequence of display in the submenu.
40987	986	0x3DA	BLINDNUMERIC3 CONFIGURATION	Read/ write Memory	See the table in BlindNumeric1Configuration(40510)
40086	85	0x55	BLINDNUMERIC4 PRESENT_VALUE	Read/ write Memory	Present value of the parameter.
40990	989	0x3DD	BLINDNUMERIC4 NAME (32-bits)	Read/ write Memory	Displaying user defined parameter name. Default name: Num2
40992	991	0x3DF	BLINDNUMERIC4 STEP	Read/ write Memory	Step of the parameter value change. The default value is 0.
40993	992	0x3E0	BLINDNUMERIC4 LOW_LIMIT	Read/ write Memory	Minimum value of the parameter. The default value is 0.
40994	993	0x3E1	BLINDNUMERIC4 HIGH_LIMIT	Read/ write Memory	Maximum value of the parameter. The default value is 0.



Modbus Address	Decimal Address	Hex Address	Register Name	Access	Description
40995	994	0x3E2	BLINDNUMERIC4 PRIORITY	Read/ write Memory	Priority of the parameter for sequence of display in the submenu.
40996	995	0x3E3	BLINDNUMERIC4 CONFIGURATION	Read/ write Memory	See the table in BlindNumeric1Configuration(40510)
40087	86	0x56	BLINDNUMERIC5 PRESENT_VALUE	Read/ write Memory	Present value of the parameter.
40999	998	0x3E6	BLINDNUMERIC5 NAME (32-bits)	Read/ write Memory	Displaying user-defined parameter name. Default name: Num2
41001	1000	0x3E8	BLINDNUMERIC5 STEP	Read/ write Memory	Step of the parameter value change. The default value is 0.
41002	1001	0x3E9	BLINDNUMERIC5 LOW_LIMIT	Read/ write Memory	Minimum value of the parameter. The default value is 0.
41003	1002	0x3EA	BLINDNUMERIC5 HIGH_LIMIT	Read/ write Memory	Maximum value of the parameter. The default value is 0.
41004	1003	0x3EB	BLINDNUMERIC5 PRIORITY	Read/ write Memory	Priority of the parameter for sequence of display in the submenu.
41005	1004	0x3EC	BLINDNUMERIC5 CONFIGURATION	Read/ write Memory	See the table in BlindNumeric1Configuration(40510)
40088	87	0x57	BLINDNUMERIC6 PRESENT_VALUE	Read/ write Memory	Present value of the parameter.
41008	1007	0x3EF	BLINDNUMERIC6 NAME (32-bits)	Read/ write Memory	Displaying user-defined parameter name. Default name: Num2
41010	1009	0x3F1	BLINDNUMERIC6 STEP	Read/ write Memory	Step of the parameter value change. The default value is 0.
41011	1010	0x3F2	BLINDNUMERIC6 LOW_LIMIT	Read/ write Memory	Minimum value of the parameter. The default value is 0.

Modbus Address	Decimal Address	Hex Address	Register Name	Access	Description
41012	1011	0x3F3	BLINDNUMERIC6 HIGH_LIMIT	Read/ write Memory	Maximum value of the parameter. The default value is 0.
41013	1012	0x3F4	BLINDNUMERIC6 PRIORITY	Read/ write Memory	Priority of the parameter for sequence of display in the submenu.
41014	1013	0x3F5	BLINDNUMERIC6 CONFIGURATION	Read/ write Memory	See the table in BlindNumeric1Configuration(40510)
40089	88	0x58	BLINDNUMERIC7 PRESENT_VALUE	Read/ write Memory	Present value of the parameter.
41017	1016	0x3F8	BLINDNUMERIC7 NAME (32-bits)	Read/ write Memory	Displaying user-defined parameter name. Default name: Num2
41019	1018	0x3FA	BLINDNUMERIC7 STEP	Read/ write Memory	Step of the parameter value change. The default value is 0.
41020	1019	0x3FB	BLINDNUMERIC7 LOW_LIMIT	Read/ write Memory	Minimum value of the parameter. The default value is 0.
41021	1020	0x3FC	BLINDNUMERIC7 HIGH_LIMIT	Read/ write Memory	Maximum value of the parameter. The default value is 0.
41022	1021	0x3FD	BLINDNUMERIC7 PRIORITY	Read/ write Memory	Priority of the parameter for sequence of display in the submenu.
41023	1022	0x3FE	BLINDNUMERIC7 CONFIGURATION	Read/ write Memory	See the table in BlindNumeric1Configuration(40510)
40090	89	0x59	BLINDNUMERIC8 PRESENT_VALUE	Read/ write Memory	Present value of the parameter.
41026	1025	0x401	BLINDNUMERIC8 NAME (32-bits)	Read/ write Memory	Displaying user-defined parameter name. Default name: Num2
41028	1027	0x403	BLINDNUMERIC8 STEP	Read/ write Memory	Step of the parameter value change. The default value is 0.

Modbus Address	Decimal Address	Hex Address	Register Name	Access	Description												
41029	1028	0x404	BLINDNUMERIC8 LOW_LIMIT	Read/ write Memory	Minimum value of the parameter. The default value is 0.												
41030	1029	0x405	BLINDNUMERIC8 HIGH_LIMIT	Read/ write Memory	Maximum value of the parameter. The default value is 0.												
41031	1030	0x406	BLINDNUMERIC8 PRIORITY	Read/ write Memory	Priority of the parameter for sequence of display in the submenu.												
41032	1031	0x407	BLINDNUMERIC8 CONFIGURATION	Read/ write Memory	See the table in BlindNumeric1Configuration(40510)												
40111	110	0x6E	BLIND_BOOLEAN_ALL PRESENT_VALUES	Read/ write Memory	See the table in 30107 register												
40146	145	0x91	BLINDBOOLEAN1 PRESENT_VALUE	Read/ write Memory	Present value of the parameter.												
41035	1034	0x40A	BLINDBOOLEAN1 NAME (32-bits)	Read/ write Memory	Displaying user-defined parameter name.												
41037	1036	0x40C	BLINDBOOLEAN1 TRUETEXT (32-bits)	Read/ write Memory	Text for parameter "true" state value.												
41039	1038	0x40E	BLINDBOOLEAN1 FALSETEXT (32-bits)	Read/ write Memory	Text for parameter "false" state value.												
41041	1040	0x410	BLINDBOOLEAN1 PRIORITY	Read/ write Memory	Priority of the parameter for sequence of display in Submenu												
41042	1041	0x411	BLINDBOOLEAN1 CONFIGURATION	Re Read/ write Memory	<table border="1"> <thead> <tr> <th>Bit</th> <th>Name</th> <th>0</th> <th>1</th> </tr> </thead> <tbody> <tr> <td>0</td> <td>Active</td> <td>Not active(def)</td> <td>Active</td> </tr> <tr> <td>1</td> <td>Editab le</td> <td>Not editable</td> <td>Editable( def)</td> </tr> </tbody> </table>	Bit	Name	0	1	0	Active	Not active(def)	Active	1	Editab le	Not editable	Editable( def)
Bit	Name	0	1														
0	Active	Not active(def)	Active														
1	Editab le	Not editable	Editable( def)														

Modbus Address	Decimal Address	Hex Address	Register Name	Access	Description												
40147	146	0x92	BLINDBOOLEAN2 PRESENT_VALUE	Read/ write Memory	Present value of the parameter.												
41045	1044	0x414	BLINDBOOLEAN2 NAME (32-bits)	Read/ write Memory	Displaying user-defined parameter name.												
41047	1046	0x416	BLINDBOOLEAN2 TRUETEXT (32-bits)	Read/ write Memory	Text for the parameter's true value.												
41049	1048	0x418	BLINDBOOLEAN2 FALSETEXT (32-bits)	Read/ write Memory	Text for the parameter's false value.												
41051	1050	0x41A	BLINDBOOLEAN2 PRIORITY	Read/ write Memory	Priority of the parameter for sequence of display in the submenu.												
41052	1051	0x41B	BLINDBOOLEAN2 CONFIGURATION	Read/ write Memory	<table border="1"> <thead> <tr> <th>Bit</th> <th>Name</th> <th>0</th> <th>1</th> </tr> </thead> <tbody> <tr> <td>0</td> <td>Active</td> <td>Not active(def)</td> <td>Active</td> </tr> <tr> <td>1</td> <td>Editable</td> <td>Not editable</td> <td>Editable(def)</td> </tr> </tbody> </table>	Bit	Name	0	1	0	Active	Not active(def)	Active	1	Editable	Not editable	Editable(def)
Bit	Name	0	1														
0	Active	Not active(def)	Active														
1	Editable	Not editable	Editable(def)														
40148	147	0x93	BLINDBOOLEAN3 PRESENT_VALUE	Read/ write Memory	Present value of the parameter.												
41055	1054	0x41E	BLINDBOOLEAN3 NAME (32-bits)	Read/ write Memory	Displaying user-defined parameter name.												
41057	1056	0x420	BLINDBOOLEAN3 TRUETEXT (32-bits)	Read/ write Memory	Text for the parameter's true value.												
41059	1058	0x422	BLINDBOOLEAN3 FALSETEXT (32-bits)	Read/ write Memory	Text for the parameter's false value.												
41061	1060	0x424	BLINDBOOLEAN3 PRIORITY	Read/ write Memory	Priority of the parameter for sequence of display in the submenu.												

Modbus Address	Decimal Address	Hex Address	Register Name	Access	Description												
41062	1061	0x425	BLINDBOOLEAN3 CONFIGURATION	Re Read/write Memory	<table border="1"> <thead> <tr> <th>Bit</th> <th>Name</th> <th>0</th> <th>1</th> </tr> </thead> <tbody> <tr> <td>0</td> <td>Active</td> <td>Not active(def)</td> <td>Active</td> </tr> <tr> <td>1</td> <td>Editabile</td> <td>Not editable</td> <td>Editable(def)</td> </tr> </tbody> </table>	Bit	Name	0	1	0	Active	Not active(def)	Active	1	Editabile	Not editable	Editable(def)
Bit	Name	0	1														
0	Active	Not active(def)	Active														
1	Editabile	Not editable	Editable(def)														
40149	148	0x94	BLINDBOOLEAN4 PRESENT_VALUE	Read/write Memory	Present value of the parameter.												
41065	1064	0x428	BLINDBOOLEAN4 NAME (32-bits)	Read/write Memory	Displaying user-defined parameter name.												
41067	1066	0x42A	BLINDBOOLEAN4 TRUETEXT (32-bits)	Read/write Memory	Text for the parameter's true value.												
41069	1068	0x42C	BLINDBOOLEAN4 FALSETEXT (32-bits)	Read/write Memory	Text for the parameter's false value.												
41071	1070	0x42E	BLINDBOOLEAN4 PRIORITY	Read/write Memory	Priority of the parameter for sequence of display in the submenu.												
41072	1071	0x42F	BLINDBOOLEAN4 CONFIGURATION	Re Read/write Memory	<table border="1"> <thead> <tr> <th>Bit</th> <th>Name</th> <th>0</th> <th>1</th> </tr> </thead> <tbody> <tr> <td>0</td> <td>Active</td> <td>Not active(def)</td> <td>Active</td> </tr> <tr> <td>1</td> <td>Editabile</td> <td>Not editable</td> <td>Editable(def)</td> </tr> </tbody> </table>	Bit	Name	0	1	0	Active	Not active(def)	Active	1	Editabile	Not editable	Editable(def)
Bit	Name	0	1														
0	Active	Not active(def)	Active														
1	Editabile	Not editable	Editable(def)														
40150	149	0x95	BLINDBOOLEAN5 PRESENT_VALUE	Read/write Memory	Present value of the parameter.												
41075	1074	0x432	BLINDBOOLEAN5 NAME (32-bits)	Read/write Memory	Displaying user-defined parameter name.												

Modbus Address	Decimal Address	Hex Address	Register Name	Access	Description												
41077	1076	0x434	BLINDBOOLEAN5 TRUETEXT (32-bits)	Read/ write Memory	Text for the parameter's true value.												
41079	1078	0x436	BLINDBOOLEAN5 FALSETEXT (32-bits)	Read/ write Memory	Text for the parameter's false value.												
41081	1080	0x438	BLINDBOOLEAN5 PRIORITY	Read/ write Memory	Priority of the parameter for sequence of display in the submenu.												
41082	1081	0x439	BLINDBOOLEAN5 CONFIGURATION	Re Read/ write Memory	<table border="1"> <thead> <tr> <th>Bit</th> <th>Name</th> <th>0</th> <th>1</th> </tr> </thead> <tbody> <tr> <td>0</td> <td>Active</td> <td>Not active(def)</td> <td>Active</td> </tr> <tr> <td>1</td> <td>Editabile</td> <td>Not editable</td> <td>Editable(def)</td> </tr> </tbody> </table>	Bit	Name	0	1	0	Active	Not active(def)	Active	1	Editabile	Not editable	Editable(def)
Bit	Name	0	1														
0	Active	Not active(def)	Active														
1	Editabile	Not editable	Editable(def)														
40151	150	0x96	BLINDBOOLEAN6 PRESENT_VALUE	Read/ write Memory	Present value of the parameter.												
41085	1084	0x43E	BLINDBOOLEAN6 NAME (32-bits)	Read/ write Memory	Displaying user-defined parameter name.												
41087	1086	0x440	BLINDBOOLEAN6 TRUETEXT (32-bits)	Read/ write Memory	Text for the parameter's true value.												
41089	1088	0x442	BLINDBOOLEAN6 FALSETEXT (32-bits)	Read/ write Memory	Text for the parameter's false value.												
41091	1090	0x444	BLINDBOOLEAN6 PRIORITY	Read/ write Memory	Priority of the parameter for sequence of display in the submenu.												
41092	1091	0x445	BLINDBOOLEAN6 CONFIGURATION	Read/ write Memory	<table border="1"> <thead> <tr> <th>Bit</th> <th>Name</th> <th>0</th> <th>1</th> </tr> </thead> <tbody> <tr> <td>0</td> <td>Active</td> <td>Not active(def)</td> <td>Active</td> </tr> </tbody> </table>	Bit	Name	0	1	0	Active	Not active(def)	Active				
Bit	Name	0	1														
0	Active	Not active(def)	Active														

Modbus Address	Decimal Address	Hex Address	Register Name	Access	Description															
					1	Editabile	Not editable	Editable(def)												
40152	151	0x97	BLINDBOOLEAN7 PRESENT_VALUE	Read/write Memory	Present value of the parameter.															
41095	1094	0x446	BLINDBOOLEAN7 NAME (32-bits)	Read/write Memory	Displaying user-defined parameter name.															
41097	1096	0x448	BLINDBOOLEAN7 TRUETEXT (32-bits)	Read/write Memory	Text for the parameter's true value.															
41099	1098	0x44A	BLINDBOOLEAN7 FALSETEXT (32-bits)	Read/write Memory	Text for the parameter's false value.															
41101	1100	0x44C	BLINDBOOLEAN7 PRIORITY	Read/write Memory	Priority of the parameter for sequence of display in the submenu.															
41102	1101	0x44D	BLINDBOOLEAN7 CONFIGURATION	Read/write Memory	<table border="1"> <tr> <td>Bit</td> <td>Name</td> <td>0</td> <td>1</td> </tr> <tr> <td>0</td> <td>Active</td> <td>Not active(def)</td> <td>Active</td> </tr> <tr> <td>1</td> <td>Editabile</td> <td>Not editable</td> <td>Editable(def)</td> </tr> </table>	Bit	Name	0	1	0	Active	Not active(def)	Active	1	Editabile	Not editable	Editable(def)			
Bit	Name	0	1																	
0	Active	Not active(def)	Active																	
1	Editabile	Not editable	Editable(def)																	
40153	152	0x98	BLINDBOOLEAN8 PRESENT_VALUE	Read/write Memory	Present value of the parameter.															
41105	1104	0x450	BLINDBOOLEAN8 NAME (32-bits)	Read/write Memory	Displaying user-defined parameter name.															
41107	1106	0x452	BLINDBOOLEAN8 TRUETEXT (32-bits)	Read/write Memory	Text for the parameter's true value.															
41109	1108	0x454	BLINDBOOLEAN8 FALSETEXT (32-bits)	Read/write Memory	Text for the parameter's false value.															

Modbus Address	Decimal Address	Hex Address	Register Name	Access	Description												
41111	1110	0x456	BLINDBOOLEAN8 PRIORITY	Read/ write Memory	Priority of the parameter for sequence of display in the submenu.												
41112	1111	0x457	BLINDBOOLEAN8 CONFIGURATION	Read/ write Memory	<table border="1"> <thead> <tr> <th>Bit</th> <th>Name</th> <th>0</th> <th>1</th> </tr> </thead> <tbody> <tr> <td>0</td> <td>Active</td> <td>Not active(def)</td> <td>Active</td> </tr> <tr> <td>1</td> <td>Editabile</td> <td>Not editable</td> <td>Editable(def)</td> </tr> </tbody> </table>	Bit	Name	0	1	0	Active	Not active(def)	Active	1	Editabile	Not editable	Editable(def)
Bit	Name	0	1														
0	Active	Not active(def)	Active														
1	Editabile	Not editable	Editable(def)														

Table 43. List of blind submenu registers

### 13.1.6 Alarms Submenu Registers

Modbus Address	Decimal Address	Hex Address	Register Name	Access	Description
40091	90	0x5A	ALARMSNUMERIC1 PRESENT_VALUE	Read/ write Memory	Present value of the parameter.
41113	1112	0x458	ALARMSMENUACTIVEPOINTS	Read/ write Memory	Number of active parameters in submenu.
41116	1115	0x45B	ALARMSNUMERIC1 NAME (32-bits)	Read/ write Memory	Displaying user-defined parameter name.
41118	1117	0x45D	ALARMSNUMERIC1 STEP	Read/ write Memory	Step of the parameter value change. The default value is 0.
41119	1118	0x45E	ALARMSNUMERIC1 LOW_LIMIT	Read/ write Memory	Minimum value of the parameter. The default value is 0.
41120	1119	0x45F	ALARMSNUMERIC1 HIGH_LIMIT	Read/ write Memory	Maximum value of the parameter. The default value is 0.
41121	1120	0x460	ALARMSNUMERIC1 PRIORITY	Read/ write Memory	Priority of the parameter for sequence of display in the submenu.



Modbus Address	Decimal Address	Hex Address	Register Name	Access	Description																																																												
41122	1121	0x461	ALARMSNUMERIC1 CONFIGURATION	Read/ write Memory	<table border="1"> <thead> <tr> <th>Bit</th> <th>Name</th> <th>0</th> <th>1</th> </tr> </thead> <tbody> <tr> <td>0</td> <td>Active</td> <td>Not active(def)</td> <td>Active(def)</td> </tr> <tr> <td>2</td> <td>FirstPointActive</td> <td>Not decimal(def)</td> <td>Decimal(def)</td> </tr> <tr> <td>3</td> <td>SecondPointActive</td> <td>Not decimal(def)</td> <td>Decimal(def)</td> </tr> <tr> <td>4</td> <td>ThirdPointActive</td> <td>Not decimal(def)</td> <td>Decimal(def)</td> </tr> <tr> <td>6</td> <td>C unit active</td> <td>not_visible(def)</td> <td>visible</td> </tr> <tr> <td>7</td> <td>F unit active</td> <td>not_visible(def)</td> <td>visible</td> </tr> <tr> <td>8</td> <td>Pa unit active</td> <td>not_visible(def)</td> <td>visible</td> </tr> <tr> <td>9</td> <td>Lx unit active</td> <td>not_visible(def)</td> <td>visible</td> </tr> <tr> <td>10</td> <td>ppm unit active</td> <td>not_visible(def)</td> <td>visible</td> </tr> <tr> <td>11</td> <td>m3/h unit active</td> <td>not_visible(def)</td> <td>visible</td> </tr> <tr> <td>12</td> <td>%Rh unit active</td> <td>not_visible(def)</td> <td>visible</td> </tr> <tr> <td>13</td> <td>l/s unit active</td> <td>not_visible(def)</td> <td>visible</td> </tr> <tr> <td>14</td> <td>% unit active</td> <td>not_visible(def)</td> <td>visible</td> </tr> <tr> <td>15</td> <td>h unit active</td> <td>not_visible(def)</td> <td>visible</td> </tr> </tbody> </table>	Bit	Name	0	1	0	Active	Not active(def)	Active(def)	2	FirstPointActive	Not decimal(def)	Decimal(def)	3	SecondPointActive	Not decimal(def)	Decimal(def)	4	ThirdPointActive	Not decimal(def)	Decimal(def)	6	C unit active	not_visible(def)	visible	7	F unit active	not_visible(def)	visible	8	Pa unit active	not_visible(def)	visible	9	Lx unit active	not_visible(def)	visible	10	ppm unit active	not_visible(def)	visible	11	m3/h unit active	not_visible(def)	visible	12	%Rh unit active	not_visible(def)	visible	13	l/s unit active	not_visible(def)	visible	14	% unit active	not_visible(def)	visible	15	h unit active	not_visible(def)	visible
Bit	Name	0	1																																																														
0	Active	Not active(def)	Active(def)																																																														
2	FirstPointActive	Not decimal(def)	Decimal(def)																																																														
3	SecondPointActive	Not decimal(def)	Decimal(def)																																																														
4	ThirdPointActive	Not decimal(def)	Decimal(def)																																																														
6	C unit active	not_visible(def)	visible																																																														
7	F unit active	not_visible(def)	visible																																																														
8	Pa unit active	not_visible(def)	visible																																																														
9	Lx unit active	not_visible(def)	visible																																																														
10	ppm unit active	not_visible(def)	visible																																																														
11	m3/h unit active	not_visible(def)	visible																																																														
12	%Rh unit active	not_visible(def)	visible																																																														
13	l/s unit active	not_visible(def)	visible																																																														
14	% unit active	not_visible(def)	visible																																																														
15	h unit active	not_visible(def)	visible																																																														

Modbus Address	Decimal Address	Hex Address	Register Name	Access	Description
40092	91	0x5B	ALARMSNUMERIC2 PRESENT_VALUE	Read/ write Memory	Present value of the parameter.
41125	1124	0x464	ALARMSNUMERIC2 NAME (32-bits)	Read/ write Memory	Displaying user-defined parameter name. Default name: Num2
41127	1126	0x466	ALARMSNUMERIC2 STEP	Read/ write Memory	Step of the parameter value change. The default value is 0.
41128	1127	0x467	ALARMSNUMERIC2 LOW_LIMIT	Read/ write Memory	Minimum value of the parameter. The default value is 0.
41129	1128	0x468	ALARMSNUMERIC2 HIGH_LIMIT	Read/ write Memory	Maximum value of the parameter. The default value is 0.
41130	1129	0x469	ALARMSNUMERIC2 PRIORITY	Read/ write Memory	Priority of the parameter for sequence of display in the submenu.
41131	1130	0x46A	ALARMSNUMERIC2 CONFIGURATION	Read/ write Memory	See the table in AlarmsNumeric1 Configuration(40510)
40093	92	0x5C	ALARMSNUMERIC3 PRESENT_VALUE	Read/ write Memory	Present value of the parameter.
41134	1133	0x46D	ALARMSNUMERIC3 NAME (32-bits)	Read/ write Memory	Displaying user-defined parameter name. Default name: Num2
41136	1135	0x46F	ALARMSNUMERIC3 STEP	Read/ write Memory	Step of the parameter value change. The default value is 0.
41137	1136	0x470	ALARMSNUMERIC3 LOW_LIMIT	Read/ write Memory	Minimum value of the parameter. The default value is 0.
41138	1137	0x471	ALARMSNUMERIC3 HIGH_LIMIT	Read/ write Memory	Maximum value of the parameter. The default value is 0.

Modbus Address	Decimal Address	Hex Address	Register Name	Access	Description
41139	1138	0x472	ALARMSNUMERIC3 PRIORITY	Read/ write Memory	Priority of the parameter for sequence of display in the submenu.
41140	1139	0x473	ALARMSNUMERIC3 CONFIGURATION	Read/ write Memory	See the table in AlarmsNumeric1 Configuration(40510)
40094	93	0x5D	ALARMSNUMERIC4 PRESENT_VALUE	Read/ write Memory	Present value of the parameter.
41143	1142	0x476	ALARMSNUMERIC4 NAME (32-bits)	Read/ write Memory	Displaying user-defined parameter name. Default name: Num2
41145	1144	0x478	ALARMSNUMERIC4 STEP	Read/ write Memory	Step of the parameter value change. The default value is 0.
41146	1145	0x479	ALARMSNUMERIC4 LOW_LIMIT	Read/ write Memory	Minimum value of the parameter. The default value is 0.
41147	1146	0x47A	ALARMSNUMERIC4 HIGH_LIMIT	Read/ write Memory	Maximum value of the parameter. The default value is 0.
41148	1147	0x47B	ALARMSNUMERIC4 PRIORITY	Read/ write Memory	Priority of the parameter for sequence of display in the submenu.
41149	1148	0x47C	ALARMSNUMERIC4 CONFIGURATION	Read/ write Memory	See the table in AlarmsNumeric1 Configuration(40510)
40095	94	0x5E	ALARMSNUMERIC5 PRESENT_VALUE	Read/ write Memory	Present value of the parameter.
41152	1151	0x47F	ALARMSNUMERIC5 NAME (32-bits)	Read/ write Memory	Displaying user-defined parameter name. Default name: Num2
41154	1153	0x481	ALARMSNUMERIC5 STEP	Read/ write Memory	Step of the parameter value change. The default value is 0.
41155	1154	0x482	ALARMSNUMERIC5 LOW_LIMIT	Read/ write Memory	Minimum value of the parameter. The default value is 0.

Modbus Address	Decimal Address	Hex Address	Register Name	Access	Description
41156	1155	0x483	ALARMSNUMERIC5 HIGH_LIMIT	Read/ write Memory	Maximum value of the parameter. The default value is 0.
41157	1156	0x484	ALARMSNUMERIC5 PRIORITY	Read/ write Memory	Priority of the parameter for sequence of display in the submenu.
41158	1157	0x485	ALARMSNUMERIC5 CONFIGURATION	Read/ write Memory	See the table in AlarmsNumeric1 Configuration(40510)
40096	95	0x5F	ALARMSNUMERIC6 PRESENT_VALUE	Read/ write Memory	Present value of the parameter.
41161	1160	0x488	ALARMSNUMERIC6 NAME (32-bits)	Read/ write Memory	Displaying user-defined parameter name. Default name: Num2
41163	1162	0x48A	ALARMSNUMERIC6 STEP	Read/ write Memory	Step of the parameter value change. The default value is 0.
41164	1163	0x48B	ALARMSNUMERIC6 LOW_LIMIT	Read/ write Memory	Minimum value of the parameter. The default value is 0.
41165	1164	0x48C	ALARMSNUMERIC6 HIGH_LIMIT	Read/ write Memory	Maximum value of the parameter. The default value is 0.
41166	1165	0x48D	ALARMSNUMERIC6 PRIORITY	Read/ write Memory	Priority of the parameter for sequence of display in the submenu.
41167	1166	0x48E	ALARMSNUMERIC6 CONFIGURATION	Read/ write Memory	See the table in AlarmsNumeric1 Configuration(40510)
40097	96	0x60	ALARMSNUMERIC7 PRESENT_VALUE	Read/ write Memory	Present value of the parameter.
41170	1169	0x491	ALARMSNUMERIC7 NAME (32-bits)	Read/ write Memory	Displaying user-defined parameter name. Default name: Num2
41172	1171	0x493	ALARMSNUMERIC7 STEP	Read/ write Memory	Step of the parameter value change. The default value is 0.

Modbus Address	Decimal Address	Hex Address	Register Name	Access	Description
41173	1172	0x494	ALARMSNUMERIC7 LOW_LIMIT	Read/ write Memory	Minimum value of the parameter. The default value is 0.
41174	1173	0x495	ALARMSNUMERIC7 HIGH_LIMIT	Read/ write Memory	Maximum value of the parameter. The default value is 0.
41175	1174	0x496	ALARMSNUMERIC7 PRIORITY	Read/ write Memory	Priority of the parameter for sequence of display in the submenu.
41176	1175	0x497	ALARMSNUMERIC7 CONFIGURATION	Read/ write Memory	See the table in AlarmsNumeric1 Configuration(40510)
40098	97	0x61	ALARMSNUMERIC8 PRESENT_VALUE	Read/ write Memory	Present value of the parameter.
41179	1178	0x49A	ALARMSNUMERIC8 NAME (32-bits)	Read/ write Memory	Displaying user-defined parameter name. Default name: Num2
41181	1180	0x49C	ALARMSNUMERIC8 STEP	Read/ write Memory	Step of the parameter value change. The default value is 0.
41182	1181	0x49D	ALARMSNUMERIC8 LOW_LIMIT	Read/ write Memory	Minimum value of the parameter. The default value is 0.
41183	1182	0x49E	ALARMSNUMERIC8 HIGH_LIMIT	Read/ write Memory	Maximum value of the parameter. The default value is 0.
41184	1183	0x49F	ALARMSNUMERIC8 PRIORITY	Read/ write Memory	Priority of the parameter for sequence of display in the submenu.
41185	1184	0x4A0	ALARMSNUMERIC8 CONFIGURATION	Read/ write Memory	See the table in AlarmsNumeric1 Configuration(40510)
40112	111	0x6F	ALARMS_ALL_PRESENT_ VALUES	Read/ write Memory	See the table in 30107 register
40138	153	0x99	ALARMSBOOLEAN1 PRESENT_VALUE	Read/ write Memory	Present value of the parameter.

Modbus Address	Decimal Address	Hex Address	Register Name	Access	Description												
40882	1187	0x4A3	ALARMSBOOLEAN1 NAME (32-bits)	Read/ write Memory	Displaying user-defined parameter name.												
40884	1189	0x4A5	ALARMSBOOLEAN1 TRUETEXT (32-bits)	Read/ write Memory	Text for the parameter's true value.												
40886	1191	0x4A7	ALARMSBOOLEAN1 FALSETEXT (32-bits)	Read/ write Memory	Text for the parameter's false value.												
40888	1193	0x4A9	ALARMSBOOLEAN1 PRIORITY	Read/ write Memory	Priority of the parameter for sequence of display in the submenu.												
41195	1194	0x4AA	ALARMSBOOLEAN1 CONFIGURATION	Re Read/ write Memory	<table border="1"> <tr> <td>Bit</td> <td>Name</td> <td>0</td> <td>1</td> </tr> <tr> <td>0</td> <td>Active</td> <td>Not active(def)</td> <td>Active</td> </tr> <tr> <td>1</td> <td>Editable</td> <td>Not editable</td> <td>Editable(def)</td> </tr> </table>	Bit	Name	0	1	0	Active	Not active(def)	Active	1	Editable	Not editable	Editable(def)
Bit	Name	0	1														
0	Active	Not active(def)	Active														
1	Editable	Not editable	Editable(def)														
40155	154	0x9A	ALARMSBOOLEAN2 PRESENT_VALUE	Read/ write Memory	Present value of the parameter.												
41199	1197	0x4AD	ALARMSBOOLEAN2 NAME (32-bits)	Read/ write Memory	Displaying user-defined parameter name.												
41201	1199	0x4AF	ALARMSBOOLEAN2 TRUETEXT (32-bits)	Read/ write Memory	Text for the parameter's true value.												
41202	1201	0x4B1	ALARMSBOOLEAN2 FALSETEXT (32-bits)	Read/ write Memory	Text for the parameter's false value.												
41204	1203	0x4B3	ALARMSBOOLEAN2 PRIORITY	Read/ write Memory	Priority of the parameter for sequence of display in the submenu.												
41205	1204	0x4B4	ALARMSBOOLEAN2 CONFIGURATION	Re Read/ write Memory	<table border="1"> <tr> <td>Bit</td> <td>Name</td> <td>0</td> <td>1</td> </tr> </table>	Bit	Name	0	1								
Bit	Name	0	1														

Modbus Address	Decimal Address	Hex Address	Register Name	Access	Description			
					0	Active	Not active(def)	Active
					1	Editable	Not editable	Editable(def)
40156	155	0x9B	ALARMSBOOLEAN3 PRESENT_VALUE	Read/write Memory	Present value of the parameter.			
41208	1207	0x4B7	ALARMSBOOLEAN3 NAME (32-bits)	Read/write Memory	Displaying user-defined parameter name.			
41210	1209	0x4B9	ALARMSBOOLEAN3 TRUETEXT (32-bits)	Read/write Memory	Text for the parameter's true value.			
41212	1211	0x4BB	ALARMSBOOLEAN3 FALSETEXT (32-bits)	Read/write Memory	Text for the parameter's false value.			
41214	1213	0x4BD	ALARMSBOOLEAN3 PRIORITY	Read/write Memory	Priority of the parameter for sequence of display in the submenu.			
41215	1214	0x4BE	ALARMSBOOLEAN3 CONFIGURATION	Re Read/write Memory	Bit	Name	0	1
					0	Active	Not active(def)	Active
					1	Editable	Not editable	Editable(def)
40157	156	0x9C	ALARMSBOOLEAN4 PRESENT_VALUE	Read/write Memory	Present value of the parameter.			
41218	1217	0x4C1	ALARMSBOOLEAN4 NAME (32-bits)	Read/write Memory	Displaying user-defined parameter name.			
41220	1219	0x4C3	ALARMSBOOLEAN4 TRUETEXT (32-bits)	Read/write Memory	Text for the parameter's true value.			

Modbus Address	Decimal Address	Hex Address	Register Name	Access	Description												
41222	1221	0x4C5	ALARMSBOOLEAN4 FALSETEXT (32-bits)	Read/ write Memory	Text for the parameter's false value.												
41224	1223	0x4C7	ALARMSBOOLEAN4 PRIORITY	Read/ write Memory	Priority of the parameter for sequence of display in the submenu.												
41225	1224	0x4C8	ALARMSBOOLEAN4 CONFIGURATION	Re Read/ write Memory	<table border="1"> <thead> <tr> <th>Bit</th> <th>Name</th> <th>0</th> <th>1</th> </tr> </thead> <tbody> <tr> <td>0</td> <td>Active</td> <td>Not active(def)</td> <td>Active</td> </tr> <tr> <td>1</td> <td>Editabile</td> <td>Not editable</td> <td>Editable(def)</td> </tr> </tbody> </table>	Bit	Name	0	1	0	Active	Not active(def)	Active	1	Editabile	Not editable	Editable(def)
Bit	Name	0	1														
0	Active	Not active(def)	Active														
1	Editabile	Not editable	Editable(def)														
40158	157	0x9D	ALARMSBOOLEAN5 PRESENT_VALUE	Read/ write Memory	Present value of the parameter												
41228	1227	0x4CB	ALARMSBOOLEAN5 NAME (32-bits)	Read/ write Memory	Displaying user-defined parameter name.												
41230	1229	0x4CD	ALARMSBOOLEAN5 TRUETEXT (32-bits)	Read/ write Memory	Text for the parameter's true value.												
41232	1231	0x4CF	ALARMSBOOLEAN5 FALSETEXT (32-bits)	Read/ write Memory	Text for the parameter's false value.												
41234	1233	0x4D1	ALARMSBOOLEAN5 PRIORITY	Read/ write Memory	Priority of the parameter for sequence of display in the submenu.												
41235	1234	0x4D2	ALARMSBOOLEAN5 CONFIGURATION	Re Read/ write Memory	<table border="1"> <thead> <tr> <th>Bit</th> <th>Name</th> <th>0</th> <th>1</th> </tr> </thead> <tbody> <tr> <td>0</td> <td>Active</td> <td>Not active(def)</td> <td>Active</td> </tr> <tr> <td>1</td> <td>Editabile</td> <td>Not editable</td> <td>Editable(def)</td> </tr> </tbody> </table>	Bit	Name	0	1	0	Active	Not active(def)	Active	1	Editabile	Not editable	Editable(def)
Bit	Name	0	1														
0	Active	Not active(def)	Active														
1	Editabile	Not editable	Editable(def)														



Modbus Address	Decimal Address	Hex Address	Register Name	Access	Description												
40159	158	0x9E	ALARMSBOOLEAN6 PRESENT_VALUE	Read/ write Memory	Present value of the parameter.												
41238	1237	0x4D5	ALARMSBOOLEAN6 NAME (32-bits)	Read/ write Memory	Displaying user-defined parameter name.												
41240	1239	0x4D7	ALARMSBOOLEAN6 TRUETEXT (32-bits)	Read/ write Memory	Text for the parameter's true value.												
41242	1241	0x4D9	ALARMSBOOLEAN6 FALSETEXT (32-bits)	Read/ write Memory	Text for the parameter's false value.												
41244	1243	0x4DB	ALARMSBOOLEAN6 PRIORITY	Read/ write Memory	Priority of the parameter for sequence of display in the submenu.												
41245	1244	0x4DC	ALARMSBOOLEAN6 CONFIGURATION	Read/ write Memory	<table border="1"> <thead> <tr> <th>Bit</th> <th>Name</th> <th>0</th> <th>1</th> </tr> </thead> <tbody> <tr> <td>0</td> <td>Active</td> <td>Not active(def)</td> <td>Active</td> </tr> <tr> <td>1</td> <td>Editable</td> <td>Not editable</td> <td>Editable(def)</td> </tr> </tbody> </table>	Bit	Name	0	1	0	Active	Not active(def)	Active	1	Editable	Not editable	Editable(def)
Bit	Name	0	1														
0	Active	Not active(def)	Active														
1	Editable	Not editable	Editable(def)														
40160	159	0x9F	ALARMSBOOLEAN7 PRESENT_VALUE	Read/ write Memory	Present value of the parameter.												
41248	1247	0x4DF	ALARMSBOOLEAN7 NAME (32-bits)	Read/ write Memory	Displaying user-defined parameter name.												
41250	1249	0x4E1	ALARMSBOOLEAN7 TRUETEXT (32-bits)	Read/ write Memory	Text for the parameter's true value.												
41252	1251	0x4E3	ALARMSBOOLEAN7 FALSETEXT (32-bits)	Read/ write Memory	Text for the parameter's false value.												
41254	1253	0x4E5	ALARMSBOOLEAN7 PRIORITY	Read/ write Memory	Priority of the parameter for sequence of display in the submenu.												

Modbus Address	Decimal Address	Hex Address	Register Name	Access	Description												
41255	1254	0x4E6	ALARMSBOOLEAN7 CONFIGURATION	Read/write Memory	<table border="1"> <thead> <tr> <th>Bit</th> <th>Name</th> <th>0</th> <th>1</th> </tr> </thead> <tbody> <tr> <td>0</td> <td>Active</td> <td>Not active(def)</td> <td>Active</td> </tr> <tr> <td>1</td> <td>Editabile</td> <td>Not editable</td> <td>Editable(def)</td> </tr> </tbody> </table>	Bit	Name	0	1	0	Active	Not active(def)	Active	1	Editabile	Not editable	Editable(def)
Bit	Name	0	1														
0	Active	Not active(def)	Active														
1	Editabile	Not editable	Editable(def)														
40161	160	0xA0	ALARMSBOOLEAN8 PRESENT_VALUE	Read/write Memory	Present value of the parameter.												
41258	1257	0x4E9	ALARMSBOOLEAN8 NAME (32-bits)	Read/write Memory	Displaying user-defined parameter name.												
41260	1259	0x4EB	ALARMSBOOLEAN8 TRUETEXT (32-bits)	Read/write Memory	Text for the parameter's true value.												
41262	1261	0x4ED	ALARMSBOOLEAN8 FALSETEXT (32-bits)	Read/write Memory	Text for the parameter's false value.												
41264	1263	0x4EF	ALARMSBOOLEAN8 PRIORITY	Read/write Memory	Priority of the parameter for sequence of display in the submenu.												
41265	1264	0x4F0	ALARMSBOOLEAN8 CONFIGURATION	Read/write Memory	<table border="1"> <thead> <tr> <th>Bit</th> <th>Name</th> <th>0</th> <th>1</th> </tr> </thead> <tbody> <tr> <td>0</td> <td>Active</td> <td>Not active(def)</td> <td>Active</td> </tr> <tr> <td>1</td> <td>Editabile</td> <td>Not editable</td> <td>Editable(def)</td> </tr> </tbody> </table>	Bit	Name	0	1	0	Active	Not active(def)	Active	1	Editabile	Not editable	Editable(def)
Bit	Name	0	1														
0	Active	Not active(def)	Active														
1	Editabile	Not editable	Editable(def)														

Table 44. List of alarms submenu registers

### 13.1.7 Occupancy Submenu Registers

Modbus Address	Decimal Address	Hex Address	Register Name	Access	Description																								
40099	98	0x62	SETTINGSNUMERIC1 PRESENT_VALUE	Read/ write Memory	Present value of the parameter.																								
41266	1265	0x4F1	SETTINGS_MENU_ACTIV E_POINTS	Read/ write Memory	Number of active parameters in submenu.																								
41269	1268	0x4F4	SETTINGSNUMERIC1 NAME (32-bits)	Read/ write Memory	Displaying user-defined parameter name.																								
40812	1270	0x4F6	SETTINGSNUMERIC1 STEP	Read/ write Memory	Step of the parameter value change. The default value is 0.																								
41272	1271	0x4F7	SETTINGSNUMERIC1 LOW_LIMIT	Read/ write Memory	Minimum value of the parameter. The default value is 0.																								
41273	1272	0x4F8	SETTINGSNUMERIC1 HIGH_LIMIT	Read/ write Memory	Maximum value of the parameter. The default value is 0.																								
41274	1273	0x4F9	SETTINGSNUMERIC1 PRIORITY	Read/ write Memory	Priority of the parameter for sequence of display in the submenu.																								
41275	1274	0x4FA	SETTINGSNUMERIC1 CONFIGURATION	Read/ write Memory	<table border="1"> <thead> <tr> <th>Bit</th> <th>Name</th> <th>0</th> <th>1</th> </tr> </thead> <tbody> <tr> <td>0</td> <td>Active</td> <td>Not active(def)</td> <td>Active(def)</td> </tr> <tr> <td>2</td> <td>FirstPointActive</td> <td>Not decimal(def)</td> <td>Decimal(def)</td> </tr> <tr> <td>3</td> <td>SecondPointActive</td> <td>Not decimal(def)</td> <td>Decimal(def)</td> </tr> <tr> <td>4</td> <td>ThirdPointActive</td> <td>Not decimal(def)</td> <td>Decimal(def)</td> </tr> <tr> <td>6</td> <td>C unit active</td> <td>not_visible(def)</td> <td>visible</td> </tr> </tbody> </table>	Bit	Name	0	1	0	Active	Not active(def)	Active(def)	2	FirstPointActive	Not decimal(def)	Decimal(def)	3	SecondPointActive	Not decimal(def)	Decimal(def)	4	ThirdPointActive	Not decimal(def)	Decimal(def)	6	C unit active	not_visible(def)	visible
Bit	Name	0	1																										
0	Active	Not active(def)	Active(def)																										
2	FirstPointActive	Not decimal(def)	Decimal(def)																										
3	SecondPointActive	Not decimal(def)	Decimal(def)																										
4	ThirdPointActive	Not decimal(def)	Decimal(def)																										
6	C unit active	not_visible(def)	visible																										

Modbus Address	Decimal Address	Hex Address	Register Name	Access	Description																																				
					<table border="1"> <tr> <td>7</td> <td>F unit active</td> <td>not_visible(def)</td> <td>visible</td> </tr> <tr> <td>8</td> <td>Pa unit active</td> <td>not_visible(def)</td> <td>visible</td> </tr> <tr> <td>9</td> <td>Lx unit active</td> <td>not_visible(def)</td> <td>visible</td> </tr> <tr> <td>10</td> <td>ppm unit active</td> <td>not_visible(def)</td> <td>visible</td> </tr> <tr> <td>11</td> <td>m3/h unit active</td> <td>not_visible(def)</td> <td>visible</td> </tr> <tr> <td>12</td> <td>%Rh unit active</td> <td>not_visible(def)</td> <td>visible</td> </tr> <tr> <td>13</td> <td>l/s unit active</td> <td>not_visible(def)</td> <td>visible</td> </tr> <tr> <td>14</td> <td>% unit active</td> <td>not_visible(def)</td> <td>visible</td> </tr> <tr> <td>15</td> <td>h unit active</td> <td>not_visible(def)</td> <td>visible</td> </tr> </table>	7	F unit active	not_visible(def)	visible	8	Pa unit active	not_visible(def)	visible	9	Lx unit active	not_visible(def)	visible	10	ppm unit active	not_visible(def)	visible	11	m3/h unit active	not_visible(def)	visible	12	%Rh unit active	not_visible(def)	visible	13	l/s unit active	not_visible(def)	visible	14	% unit active	not_visible(def)	visible	15	h unit active	not_visible(def)	visible
7	F unit active	not_visible(def)	visible																																						
8	Pa unit active	not_visible(def)	visible																																						
9	Lx unit active	not_visible(def)	visible																																						
10	ppm unit active	not_visible(def)	visible																																						
11	m3/h unit active	not_visible(def)	visible																																						
12	%Rh unit active	not_visible(def)	visible																																						
13	l/s unit active	not_visible(def)	visible																																						
14	% unit active	not_visible(def)	visible																																						
15	h unit active	not_visible(def)	visible																																						
40100	99	0x63	SETTINGSNUMERIC2 PRESENT_VALUE	Read/write Memory	Present value of the parameter.																																				
41278	1277	0x4FD	SETTINGSNUMERIC2 NAME (32-bits)	Read/write Memory	Displaying user-defined parameter name. Default name: Num2																																				
41280	1279	0x4FF	SETTINGSNUMERIC2 STEP	Read/write Memory	Step of the parameter value change. The default value is 0.																																				
41281	1280	0x500	SETTINGSNUMERIC2 LOW_LIMIT	Read/write Memory	Minimum value of the parameter. The default value is 0.																																				
41282	1281	0x501	SETTINGSNUMERIC2 HIGH_LIMIT	Read/write Memory	Maximum value of the parameter. The default value is 0.																																				
41283	1282	0x502	SETTINGSNUMERIC2 PRIORITY	Read/write Memory	Priority of the parameter for sequence of display in the submenu.																																				

Modbus Address	Decimal Address	Hex Address	Register Name	Access	Description
41284	1283	0x503	SETTINGSNUMERIC2 CONFIGURATION	Read/ write Memory	See the table in SettingsNumeric1Configuration(40510)
40101	100	0x64	SETTINGSNUMERIC3 PRESENT_VALUE	Read/ write Memory	Present value of the parameter.
41287	1286	0x506	SETTINGSNUMERIC3 NAME (32-bits)	Read/ write Memory	Displaying user-defined parameter name. Default name: Num2
41289	1288	0x508	SETTINGSNUMERIC3 STEP	Read/ write Memory	Step of the parameter value change. The default value is 0.
41290	1289	0x509	SETTINGSNUMERIC3 LOW_LIMIT	Read/ write Memory	Minimum value of the parameter. The default value is 0.
41291	1290	0x50A	SETTINGSNUMERIC3 HIGH_LIMIT	Read/ write Memory	Maximum value of the parameter. The default value is 0.
41292	1291	0x50B	SETTINGSNUMERIC3 PRIORITY	Read/ write Memory	Priority of the parameter for sequence of display in the submenu.
41293	1292	0x50C	SETTINGSNUMERIC3 CONFIGURATION	Read/ write Memory	See the table in SettingsNumeric1Configuration(40510)
40102	101	0x65	SETTINGSNUMERIC4 PRESENT_VALUE	Read/ write Memory	Present value of the parameter.
41296	1295	0x50F	SETTINGSNUMERIC4 NAME (32-bits)	Read/ write Memory	Displaying user-defined parameter name. Default name: Num2
41298	1297	0x511	SETTINGSNUMERIC4 STEP	Read/ write Memory	Step of the parameter value change. The default value is 0.
41299	1298	0x512	SETTINGSNUMERIC4 LOW_LIMIT	Read/ write Memory	Minimum value of the parameter. The default value is 0.
41300	1299	0x513	SETTINGSNUMERIC4 HIGH_LIMIT	Read/ write Memory	Maximum value of the parameter. The default value is 0.

Modbus Address	Decimal Address	Hex Address	Register Name	Access	Description
41301	1300	0x514	SETTINGSNUMERIC4 PRIORITY	Read/ write Memory	Priority of the parameter for sequence of display in the submenu.
41302	1301	0x515	SETTINGSNUMERIC4 CONFIGURATION	Read/ write Memory	See the table in SettingsNumeric1Configuration(40510)
40103	102	0x66	SETTINGSNUMERIC5 PRESENT_VALUE	Read/ write Memory	Present value of the parameter.
41305	1304	0x518	SETTINGSNUMERIC5 NAME (32-bits)	Read/ write Memory	Displaying user-defined parameter name. Default name: Num2
41307	1306	0x51A	SETTINGSNUMERIC5 STEP	Read/ write Memory	Step of the parameter value change. The default value is 0.
41308	1307	0x51B	SETTINGSNUMERIC5 LOW_LIMIT	Read/ write Memory	Minimum value of the parameter. The default value is 0.
41309	1308	0x51C	SETTINGSNUMERIC5 HIGH_LIMIT	Read/ write Memory	Maximum value of the parameter. The default value is 0.
41310	1309	0x51D	SETTINGSNUMERIC5 PRIORITY	Read/ write Memory	Priority of the parameter for sequence of display in the submenu.
41311	1310	0x51E	SETTINGSNUMERIC5 CONFIGURATION	Read/ write Memory	See the table in SettingsNumeric1Configuration(40510)
40104	103	0x67	SETTINGSNUMERIC6 PRESENT_VALUE	Read/ write Memory	Present value of the parameter.
41314	1313	0x521	SETTINGSNUMERIC6 NAME (32-bits)	Read/ write Memory	Displaying user-defined parameter name. Default name: Num2
41316	1315	0x523	SETTINGSNUMERIC6 STEP	Read/ write Memory	Step of the parameter value change. The default value is 0.
41317	1316	0x524	SETTINGSNUMERIC6 LOW_LIMIT	Read/ write Memory	Minimum value of the parameter. The default value is 0.

Modbus Address	Decimal Address	Hex Address	Register Name	Access	Description
41318	1317	0x525	SETTINGSNUMERIC6 HIGH_LIMIT	Read/ write Memory	Maximum value of the parameter. The default value is 0.
41319	1318	0x526	SETTINGSNUMERIC6 PRIORITY	Read/ write Memory	Priority of the parameter for sequence of display in the submenu.
41320	1319	0x527	SETTINGSNUMERIC6 CONFIGURATION	Read/ write Memory	See the table in SettingsNumeric1Configuration(4051 0)
40105	104	0x68	SETTINGSNUMERIC7 PRESENT_VALUE	Read/ write Memory	Present value of the parameter.
41323	1322	0x52A	SETTINGSNUMERIC7 NAME (32-bits)	Read/ write Memory	Displaying user-defined parameter name. Default name: Num2
41325	1324	0x52C	SETTINGSNUMERIC7 STEP	Read/ write Memory	Step of the parameter value change. The default value is 0.
41326	1325	0x52D	SETTINGSNUMERIC7 LOW_LIMIT	Read/ write Memory	Minimum value of the parameter. The default value is 0.
41327	1326	0x52E	SETTINGSNUMERIC7 HIGH_LIMIT	Read/ write Memory	Maximum value of the parameter. The default value is 0.
41328	1327	0x52F	SETTINGSNUMERIC7 PRIORITY	Read/ write Memory	Priority of the parameter for sequence of display in the submenu.
41329	1328	0x530	SETTINGSNUMERIC7 CONFIGURATION	Read/ write Memory	See the table in SettingsNumeric1Configuration(4051 0)
40106	105	0x69	SETTINGSNUMERIC8 PRESENT_VALUE	Read/ write Memory	Present value of the parameter
41332	1331	0x533	SETTINGSNUMERIC8 NAME (32-bits)	Read/ write Memory	Displaying user-defined parameter name. Default name: Num2
41334	1333	0x535	SETTINGSNUMERIC8 STEP	Read/ write Memory	Step of the parameter value change. The default value is 0.

Modbus Address	Decimal Address	Hex Address	Register Name	Access	Description												
41335	1334	0x536	SETTINGSNUMERIC8 LOW_LIMIT	Read/ write Memory	Minimum value of the parameter. The default value is 0.												
41336	1335	0x537	SETTINGSNUMERIC8 HIGH_LIMIT	Read/ write Memory	Maximum value of the parameter. The default value is 0.												
41337	1336	0x538	SETTINGSNUMERIC8 PRIORITY	Read/ write Memory	Priority of the parameter for sequence of display in the submenu.												
41338	1337	0x539	SETTINGSNUMERIC8 CONFIGURATION	Read/ write Memory	See the table in SettingsNumeric1Configuration(4051 0)												
40113	112	0x70	OCCUPANCY_ALL PRESENT_VALUES	Read/ write Memory	See the table in 30107 register												
40162	161	0xA1	SETTINGSBOOLEAN1 PRESENT_VALUE	Read/ write Memory	Present value of the parameter.												
41341	1340	0x53C	SETTINGSBOOLEAN1 NAME (32-bits)	Read/ write Memory	Displaying user-defined parameter name.												
41343	1342	0x53E	SETTINGSBOOLEAN1 TRUETEXT (32-bits)	Read/ write Memory	Text for the parameter's true value.												
41345	1344	0x540	SETTINGSBOOLEAN1 FALSETEXT (32-bits)	Read/ write Memory	Text for the parameter's false value.												
41347	1346	0x542	SETTINGSBOOLEAN1 PRIORITY	Read/ write Memory	Priority of the parameter for sequence of display in the submenu.												
41348	1347	0x543	SETTINGSBOOLEAN1 CONFIGURATION	Re Read/ write Memory	<table border="1"> <thead> <tr> <th>Bit</th> <th>Name</th> <th>0</th> <th>1</th> </tr> </thead> <tbody> <tr> <td>0</td> <td>Active</td> <td>Not active(def)</td> <td>Active</td> </tr> <tr> <td>1</td> <td>Editab le</td> <td>Not editable</td> <td>Editable( def)</td> </tr> </tbody> </table>	Bit	Name	0	1	0	Active	Not active(def)	Active	1	Editab le	Not editable	Editable( def)
Bit	Name	0	1														
0	Active	Not active(def)	Active														
1	Editab le	Not editable	Editable( def)														



Modbus Address	Decimal Address	Hex Address	Register Name	Access	Description												
40163	162	0xA2	SETTINGSBOOLEAN2 PRESENT_VALUE	Read/write Memory	Present value of the parameter.												
41351	1350	0x546	SETTINGSBOOLEAN2 NAME (32-bits)	Read/write Memory	Displaying user-defined parameter name.												
41353	1352	0x548	SETTINGSBOOLEAN2 TRUETEXT (32-bits)	Read/write Memory	Text for the parameter's true value.												
41355	1354	0x54A	SETTINGSBOOLEAN2 FALSETEXT (32-bits)	Read/write Memory	Text for the parameter's false value.												
41357	1356	0x54C	SETTINGSBOOLEAN2 PRIORITY	Read/write Memory	Priority of the parameter for sequence of display in the submenu.												
41358	1357	0x54E	SETTINGSBOOLEAN2 CONFIGURATION	Read/write Memory	<table border="1"> <thead> <tr> <th>Bit</th> <th>Name</th> <th>0</th> <th>1</th> </tr> </thead> <tbody> <tr> <td>0</td> <td>Active</td> <td>Not active(def)</td> <td>Active</td> </tr> <tr> <td>1</td> <td>Editable</td> <td>Not editable</td> <td>Editable(def)</td> </tr> </tbody> </table>	Bit	Name	0	1	0	Active	Not active(def)	Active	1	Editable	Not editable	Editable(def)
Bit	Name	0	1														
0	Active	Not active(def)	Active														
1	Editable	Not editable	Editable(def)														
40164	163	0xA3	SETTINGSBOOLEAN3 PRESENT_VALUE	Read/write Memory	Present value of the parameter.												
41361	1360	0x550	SETTINGSBOOLEAN3 NAME (32-bits)	Read/write Memory	Displaying user-defined parameter name.												
41363	1362	0x552	SETTINGSBOOLEAN3 TRUETEXT (32-bits)	Read/write Memory	Text for the parameter's true value.												
41365	1364	0x554	SETTINGSBOOLEAN3 FALSETEXT (32-bits)	Read/write Memory	Text for the parameter's false value.												
41367	1366	0x556	SETTINGSBOOLEAN3 PRIORITY	Read/write Memory	Priority of the parameter for sequence of display in the submenu.												

Modbus Address	Decimal Address	Hex Address	Register Name	Access	Description												
41368	1367	0x557	SETTINGSBOOLEAN3 CONFIGURATION	Re Read/write Memory	<table border="1"> <thead> <tr> <th>Bit</th> <th>Name</th> <th>0</th> <th>1</th> </tr> </thead> <tbody> <tr> <td>0</td> <td>Active</td> <td>Not active(def)</td> <td>Active</td> </tr> <tr> <td>1</td> <td>Editabile</td> <td>Not editable</td> <td>Editable(def)</td> </tr> </tbody> </table>	Bit	Name	0	1	0	Active	Not active(def)	Active	1	Editabile	Not editable	Editable(def)
Bit	Name	0	1														
0	Active	Not active(def)	Active														
1	Editabile	Not editable	Editable(def)														
40165	164	0xA4	SETTINGSBOOLEAN4 PRESENT_VALUE	Read/write Memory	Present value of the parameter.												
41371	1370	0x55A	SETTINGSBOOLEAN4 NAME (32-bits)	Read/write Memory	Displaying user-defined parameter name.												
41373	1372	0x55C	SETTINGSBOOLEAN4 TRUETEXT (32-bits)	Read/write Memory	Text for the parameter's true value.												
41375	1374	0x55E	SETTINGSBOOLEAN4 FALSETEXT (32-bits)	Read/write Memory	Text for the parameter's false value.												
41377	1376	0x560	SETTINGSBOOLEAN4 PRIORITY	Read/write Memory	Priority of the parameter for sequence of display in the submenu.												
41378	1377	0x561	SETTINGSBOOLEAN4 CONFIGURATION	Re Read/write Memory	<table border="1"> <thead> <tr> <th>Bit</th> <th>Name</th> <th>0</th> <th>1</th> </tr> </thead> <tbody> <tr> <td>0</td> <td>Active</td> <td>Not active(def)</td> <td>Active</td> </tr> <tr> <td>1</td> <td>Editabile</td> <td>Not editable</td> <td>Editable(def)</td> </tr> </tbody> </table>	Bit	Name	0	1	0	Active	Not active(def)	Active	1	Editabile	Not editable	Editable(def)
Bit	Name	0	1														
0	Active	Not active(def)	Active														
1	Editabile	Not editable	Editable(def)														
40166	165	0xA5	SETTINGSBOOLEAN5 PRESENT_VALUE	Read/write Memory	Present value of the parameter.												
41381	1380	0x564	SETTINGSBOOLEAN5 NAME (32-bits)	Read/write Memory	Displaying user-defined parameter name.												

Modbus Address	Decimal Address	Hex Address	Register Name	Access	Description												
41383	1382	0x566	SETTINGSBOOLEAN5 TRUETEXT (32-bits)	Read/ write Memory	Text for the parameter's true value.												
41385	1384	0x568	SETTINGSBOOLEAN5 FALSETEXT (32-bits)	Read/ write Memory	Text for the parameter's false value.												
41387	1386	0x56A	SETTINGSBOOLEAN5 PRIORITY	Read/ write Memory	Priority of the parameter for sequence of display in the submenu.												
41388	1387	0x56B	SETTINGSBOOLEAN5 CONFIGURATION	Read/ write Memory	<table border="1"> <thead> <tr> <th>Bit</th> <th>Name</th> <th>0</th> <th>1</th> </tr> </thead> <tbody> <tr> <td>0</td> <td>Active</td> <td>Not active(def)</td> <td>Active</td> </tr> <tr> <td>1</td> <td>Editab le</td> <td>Not editable</td> <td>Editable( def)</td> </tr> </tbody> </table>	Bit	Name	0	1	0	Active	Not active(def)	Active	1	Editab le	Not editable	Editable( def)
Bit	Name	0	1														
0	Active	Not active(def)	Active														
1	Editab le	Not editable	Editable( def)														
40167	166	0xA6	SETTINGSBOOLEAN6 PRESENT_VALUE	Read/ write Memory	Present value of the parameter.												
41391	1390	0x56E	SETTINGSBOOLEAN6 NAME (32-bits)	Read/ write Memory	Displaying user-defined parameter name.												
41393	1392	0x570	SETTINGSBOOLEAN6 TRUETEXT (32-bits)	Read/ write Memory	Text for the parameter's true value.												
41395	1394	0x572	SETTINGSBOOLEAN6 FALSETEXT (32-bits)	Read/ write Memory	Text for the parameter's false value.												
41397	1396	0x574	SETTINGSBOOLEAN6 PRIORITY	Read/ write Memory	Priority of the parameter for sequence of display in the submenu.												
41398	1397	0x575	SETTINGSBOOLEAN6 CONFIGURATION	Read/ write Memory	<table border="1"> <thead> <tr> <th>Bit</th> <th>Name</th> <th>0</th> <th>1</th> </tr> </thead> <tbody> <tr> <td>0</td> <td>Active</td> <td>Not active(def)</td> <td>Active</td> </tr> </tbody> </table>	Bit	Name	0	1	0	Active	Not active(def)	Active				
Bit	Name	0	1														
0	Active	Not active(def)	Active														

Modbus Address	Decimal Address	Hex Address	Register Name	Access	Description															
					1	Editabile	Not editable	Editable(def)												
40168	167	0xA7	SETTINGSBOOLEAN7 PRESENT_VALUE	Read/write Memory	Present value of the parameter.															
41401	1400	0x578	SETTINGSBOOLEAN7 NAME (32-bits)	Read/write Memory	Displaying user-defined parameter name.															
41403	1402	0x57A	SETTINGSBOOLEAN7 TRUETEXT (32-bits)	Read/write Memory	Text for the parameter's true value.															
41405	1404	0x57C	SETTINGSBOOLEAN7 FALSETEXT (32-bits)	Read/write Memory	Text for the parameter's false value.															
41407	1406	0x57E	SETTINGSBOOLEAN7 PRIORITY	Read/write Memory	Priority of the parameter for sequence of display in the submenu.															
41408	1407	0x57F	SETTINGSBOOLEAN7 CONFIGURATION	Read/write Memory	<table border="1"> <tr> <td>Bit</td> <td>Name</td> <td>0</td> <td>1</td> </tr> <tr> <td>0</td> <td>Active</td> <td>Not active(def)</td> <td>Active</td> </tr> <tr> <td>1</td> <td>Editabile</td> <td>Not editable</td> <td>Editable(def)</td> </tr> </table>	Bit	Name	0	1	0	Active	Not active(def)	Active	1	Editabile	Not editable	Editable(def)			
Bit	Name	0	1																	
0	Active	Not active(def)	Active																	
1	Editabile	Not editable	Editable(def)																	
40169	168	0xA8	SETTINGSBOOLEAN8 PRESENT_VALUE	Read/write Memory	Present value of the parameter.															
41411	1410	0x582	SETTINGSBOOLEAN8 NAME (32-bits)	Read/write Memory	Displaying user-defined parameter name.															
41413	1412	0x584	SETTINGSBOOLEAN8 TRUETEXT (32-bits)	Read/write Memory	Text for the parameter's true value.															
41415	1414	0x586	SETTINGSBOOLEAN8 FALSETEXT (32-bits)	Read/write Memory	Text for the parameter's false value.															

Modbus Address	Decimal Address	Hex Address	Register Name	Access	Description												
41417	1416	0x588	SETTINGSBOOLEAN8 PRIORITY	Read/ write Memory	Priority of the parameter for sequence of display in the submenu.												
41418	1417	0x589	SETTINGSBOOLEAN8 CONFIGURATION	Read/ write Memory	<table border="1"> <thead> <tr> <th>Bit</th> <th>Name</th> <th>0</th> <th>1</th> </tr> </thead> <tbody> <tr> <td>0</td> <td>Active</td> <td>Not active(def)</td> <td>Active</td> </tr> <tr> <td>1</td> <td>Editable</td> <td>Not editable</td> <td>Editable(def)</td> </tr> </tbody> </table>	Bit	Name	0	1	0	Active	Not active(def)	Active	1	Editable	Not editable	Editable(def)
Bit	Name	0	1														
0	Active	Not active(def)	Active														
1	Editable	Not editable	Editable(def)														

Table 45. List of occupancy submenu registers