

iSMA-B-FCU

User Manual

Quick Start-up

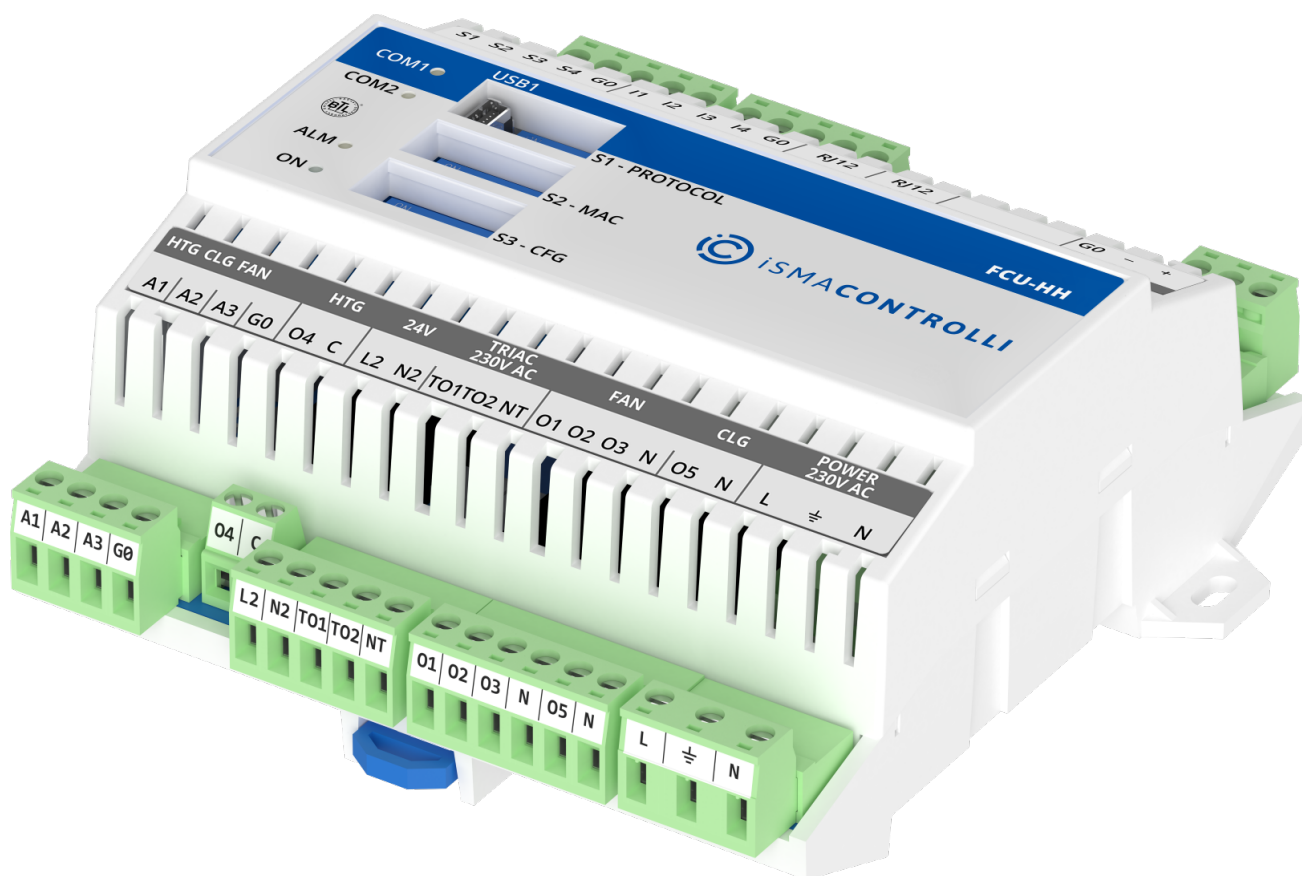


Table of Contents

1	Introduction	4
1.1	Revision History.....	4
2	Overview	5
2.1	Box Contents	5
2.2	Tools	5
2.3	Dimensions and Mounting.....	5
2.4	Technical Specification	5
3	Configuring and Connecting the Controller	6
3.1	Controller Overview	6
3.2	Step 1: Selecting Protocol and Baud Rate; Restoring the Default Settings	7
3.2.1	PROTOCOL DIP Switch Configuration.....	7
3.2.2	Restoring Default Settings.....	8
3.3	Step 2: Setting Controller Address.....	9
3.3.1	MAC DIP Switch Configuration	9
3.4	Step 3: Choosing the FCU Pipe Type	10
3.4.1	4-Pipe Heating and Cooling	10
3.4.2	2-Pipe Only Heating or Only Cooling	11
3.5	Step 4: Switching Between 1 Heating Stage and 2 Heating Stages Modes.....	12
3.5.1	2 Stages of Heating in 4-Pipe Fan Coil Unit.....	13
3.6	Step 5: Switching Between 1 Cooling Stage and 2 Cooling Stages Modes.....	13
3.6.1	2 Stages of Cooling in 4-Pipe Fan Coil Unit	13
3.7	Step 6: Selecting Type of Control Required by the FCU Valves and Connection Details.....	14
3.8	Step 7: Selecting the Temperature Control Value Source and its Connection Details.....	16
3.8.1	Temperature Source: iSMA-B-LP/Touch Point/FP Room Panel.....	16
3.8.2	Temperature Source Connected to S3	16
3.8.3	Temperature Source Connected to S1	17
3.8.4	Temperature Source Connected to RS485 Network.....	17
3.9	Step 8: Selecting Type of Fan Used Within the Project and its Connection Details ...	18
3.9.1	Analog Controlled Fan Connection	18
3.9.2	1 Speed Fan Connection.....	18
3.9.3	2 Speeds Fan Connection.....	19
3.9.4	3 Speeds Fan Connection.....	20
4	Examples: Connecting Actuators and Sensors to the Controller	21

4.1 Connections Overview.....21

4.2 Connection Examples.....21

4.2.1 4-Pipe Installation with 1 Stage Digital Controlled Heating and Cooling and Analog Controlled Fan 21

4.2.2 4-Pipe Installation with 1 Stage Digital Controlled Heating and Cooling and 1 Speed Fan..... 22

4.2.3 4-Pipe Installation with 1 Stage Digital Controlled Heating and Cooling and 2 Speeds Fan..... 22

4.2.4 4-Pipe Installation with 1 Stage Digital Controlled Heating and Cooling and 3 Speeds Fan..... 23

4.2.5 4-Pipe Installation with 1 Stage Analog Controlled Heating and Cooling and Analog Controlled Fan 23

4.2.6 4-Pipe Installation with 1 Stage Analog Controlled Heating and Cooling and 1 Speed Fan..... 24

4.2.7 4-Pipe Installation with 1 Stage Analog Controlled Heating and Cooling and 2 Speeds Fan..... 24

4.2.8 4-Pipe Installation with 1 Stage Analog Controlled Heating and Cooling and 3 Speeds Fan..... 25

4.2.9 2-Pipe Installation with 1 Stage Digital Controlled Cooling and Analog Controlled Fan..... 25

4.2.10 2-Pipe Installation with 1 Stage Digital Controlled Heating and 1 Speed Fan 26

4.2.11 2-Pipe Installation with 1 Stage Digital Controlled Cooling and 2 Speeds Fan..... 26

4.2.12 2-Pipe Installation with 1 Stage Digital Controlled Heating and 3 Speeds Fan 27

4.2.13 2-Pipe Installation with 1 Stage Analog Controlled Cooling and Analog Controlled Fan..... 27

4.2.14 2-Pipe Installation with 1 Stage Analog Controlled Heating and 1 Speed Fan 28

4.2.15 2-Pipe Installation with 1 Stage Analog Controlled Cooling and 2 Speeds Fan 28

4.2.16 2-Pipe Installation with 1 Stage Analog Controlled Heating and 3 Speeds Fan 29

5 All Configurations for FCU Default Application..... 30

1 Introduction

This manual explains basic procedures for using the controller, setting up the built-in application and information on connection details. It is recommended to read this manual before using the controller. For detailed operating procedures and troubleshooting information, see user manuals: FCU Programming, FCU Application, FCU Hardware, FCU Updater.

1.1 Revision History

Rev.	Date	Description
1.2	21 Feb 2023	<ul style="list-style-type: none"> • Updated information about the default settings (values stored in the EEPROM memory cleared while restoring to default settings) • Updated FP panel references
1.1	21 Apr 2022	<ul style="list-style-type: none"> • Rebranded • Updated Touch Point panel references
1.0	5 Mar 2021	First edition

Table 1. Revision history

2 Overview

2.1 Box Contents

The iSMA-B-FCU controller comes in a box along with the connectors and the iSMA-B-FCU installation instruction.

2.2 Tools

To safely and properly set up the iSMA-B-FCU controller, the flat head screwdriver 3.0 x 0.5 mm is necessary.

2.3 Dimensions and Mounting

The controller dimensions and mounting details are presented on the figure 1. There are no additional requirements for controller's orientation and placement.

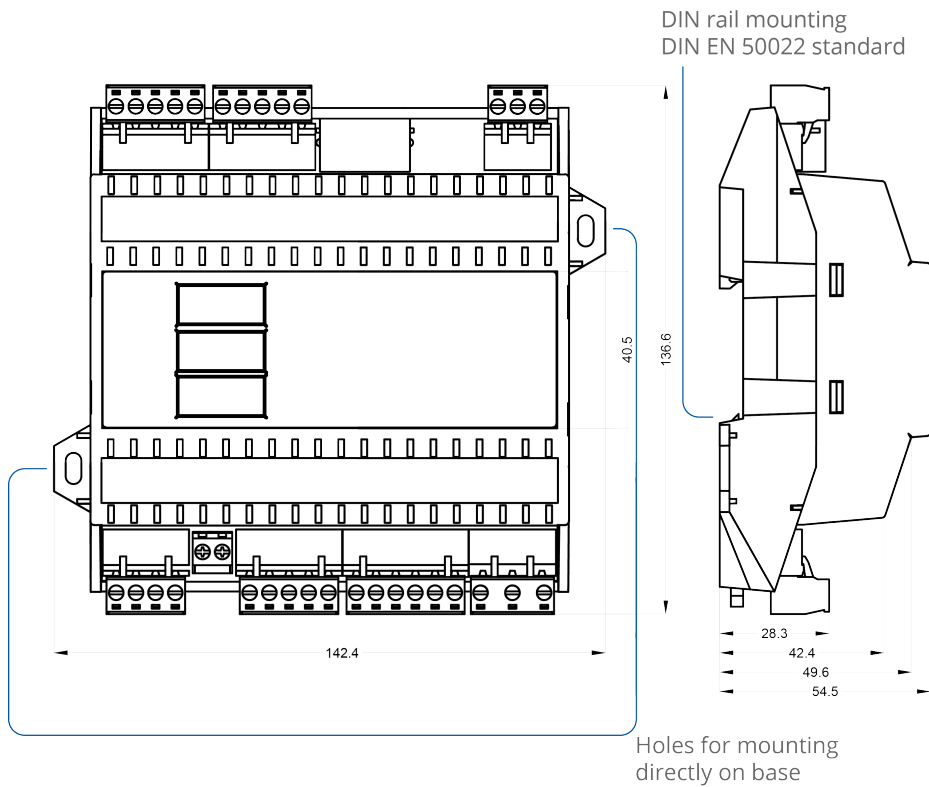


Figure 1. FCU dimensions and mounting

2.4 Technical Specification

For detailed technical specification, see the FCU Hardware manual.

3 Configuring and Connecting the Controller

3.1 Controller Overview

This section outlines the differences between the FCU hardware versions and describes steps required to properly configure the controller. For further information, please see the iSMA-B-FCU Hardware manual.

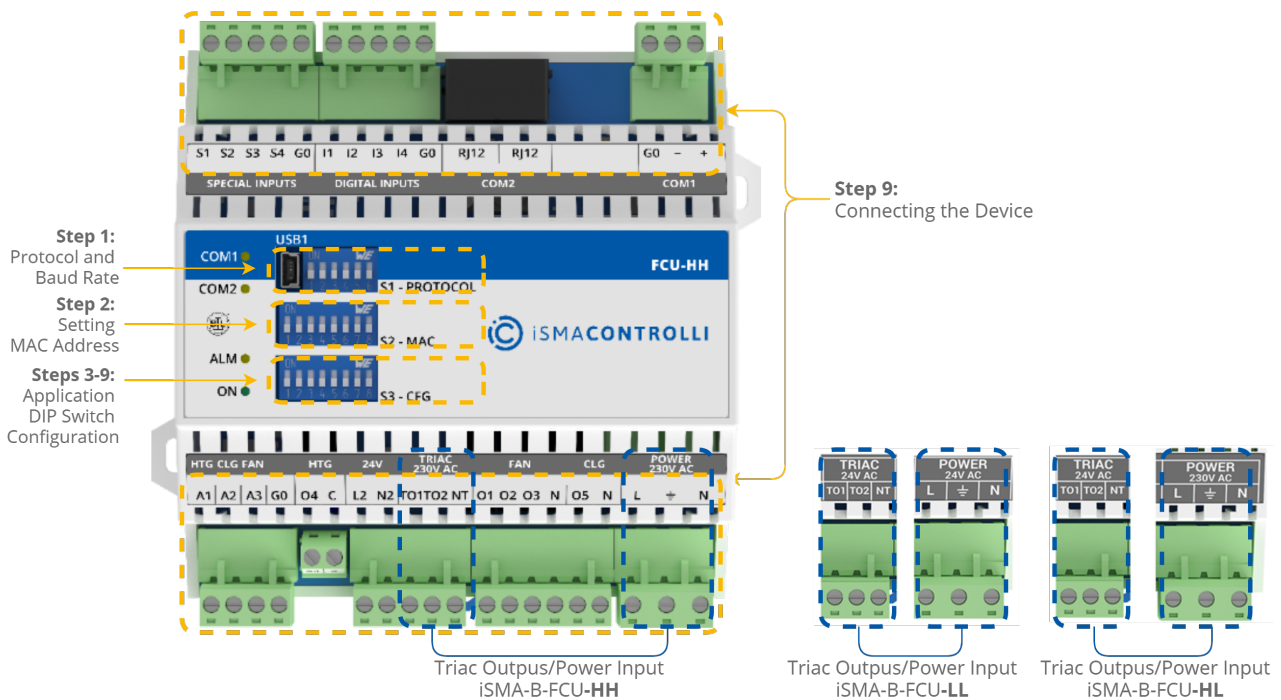


Figure 2. FCU controller HH version; HL and LL versions with different power voltages

The PROTOCOL DIP switch is responsible for configuring the communication protocol.

The MAC DIP switch is responsible for addressing the controller.

The CFG DIP switch is responsible for configuring the application.

Note: The detailed information about the DIP switches configuration is available in the FCU Hardware manual.

The iSMA-B-FCU controller configuration step by step is described in chapter 3 of this document and consists of steps:

Step 1: configuration of the PROTOCOL DIP switch responsible for selecting used protocol and its baud rate, and restoring the controller to the default settings;

Step 2: selecting the address of the controller by the MAC DIP switch;

Step 3: selecting the FCU pipe type;

Step 4: selecting 1 or 2 stages of heating;

Step 5: selecting 1 or 2 stages of cooling;

Step 6: selecting the type of control the FCU valves require, and heating and cooling actuators connection details;

Step 7: selecting the temperature control value source;

Step 8: selecting the type of fan used within the project.

Steps 3-8 describe configuration of the CFG DIP switch. Their overview with default positioning is presented in the table below.

No.	Name	On	Off	Default
1	Pipe Mode	2-pipe	4-pipe	4-pipe
2	Heating 2nd Stage	Enable	Disable	Disable
3	Cooling 2nd Stage	Enable	Disable	Disable
4	Heating/cooling control mode	Analog	Digital	Digital

Table 2. The CFG DIP switch configuration

WARNING! Before attempting to configure the controller, make sure to have acquainted with all the required documentation, or have a good knowledge of the fan coil unit application–this will make configuration of the controller easy-going and trouble-free.

3.2 Step 1: Selecting Protocol and Baud Rate; Restoring the Default Settings

3.2.1 PROTOCOL DIP Switch Configuration

Depending on the communication protocol, used within the network the controller is connected to, there is a possibility to switch the protocol used by the controller so it matches the network protocol.

The protocol, which the controller operates with, and baud rate selection is made with the PROTOCOL DIP switch.

The 1st, 2nd, and 3rd switches are responsible for baud rate, while the 4th and 5th are responsible for the protocol. The 6th switch is responsible for restoring the default settings.

The PROTOCOL DIP switch settings for baud rate and protocol selection are shown in tables below.

1	2	3	Baud Rate
OFF (0)	OFF (0)	OFF (0)	Defined by user
OFF (0)	OFF (0)	ON (1)	76800
OFF (0)	ON (1)	OFF (0)	4800
OFF (0)	ON (1)	ON (1)	9600

1	2	3	Baud Rate
ON (1)	OFF (0)	OFF (0)	19200
ON (1)	OFF (0)	ON (1)	38400
ON (1)	ON (1)	OFF (0)	57600
ON (1)	ON (1)	ON (1)	115200

Table 3. Baud rate configuration

4	5	Protocol
OFF (0)	OFF (0)	Modbus RTU
OFF (0)	ON (1)	Modbus ASCII
ON (1)	OFF (0)	BACnet Master
ON (1)	ON (1)	BACnet Slave

Table 4. Protocol configuration

3.2.2 Restoring Default Settings

To restore the default iSMA-B-FCU device settings, follow the steps below:

- Turn off the power supply.
- Set the 6th switch of the PROTOCOL DIP switch to ON.
- Turn on the power supply, wait until the power LED is blinking.
- Set the 6th switch to OFF to restore the default settings. To cancel the reset, turn off the power supply and set the 6th switch to the OFF position.

Out of the box device, as well as after restoring default values procedure, has the default settings as shown in the table below. All parameters can be changed using the iSMATool software with the controller connected, only the baud rate and used protocol can be modified with DIP switches.

Name	Default Value
User baud rate	76800
Stop bits	1
Data bits	8
Parity bit	0
Response delay	0

Name	Default Value
I1-I4 digital input counters	0
Values stored in the EEPROM memory	Cleared

Table 5. Default values

For more information on changing the protocol parameters, check the FCU Application manual and FCU Hardware manual.

3.3 Step 2: Setting Controller Address

3.3.1 MAC DIP Switch Configuration

For the controller to operate correctly in the network, its address needs to be set to the desired value. The controller address is set by the MAC DIP switch. The state of the MAC DIP switch represents binary information of the controller address. The first 10 addresses and corresponding DIP switch setting is shown below.

Address	S1	S2	S3	S4	S5	S6	S7	S8	MAC DIP Switch Configuration
1	On								
2		On							
3	On	On							
4			On						
5	On		On						
6		On	On						

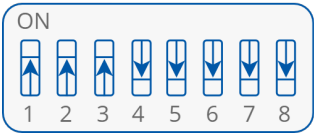
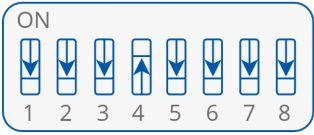
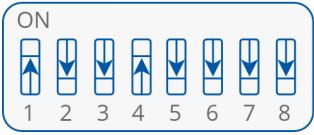
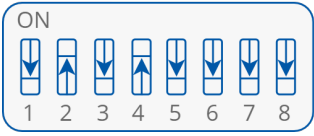
Address	S1	S2	S3	S4	S5	S6	S7	S8	MAC DIP Switch Configuration
7	On	On	On						
8				On					
9	On			On					
10		On		On					

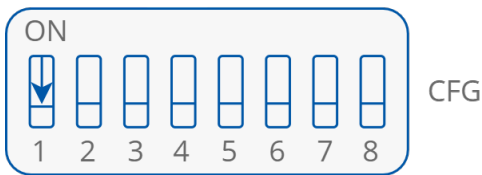
Table 6. MAC DIP switch configuration

For another address DIP switch configuration, see the iSMA-B-FCU Hardware manual.

3.4 Step 3: Choosing the FCU Pipe Type

The iSMA-B-FCU can be used in 4-pipe installations as well as in 2-pipe installations. In order for the controller to operate correctly in the application, it is necessary to know the fan coil pipe type and set the CFG DIP switch to the corresponding settings as described below.

3.4.1 4-Pipe Heating and Cooling



4-pipe-heating and cooling

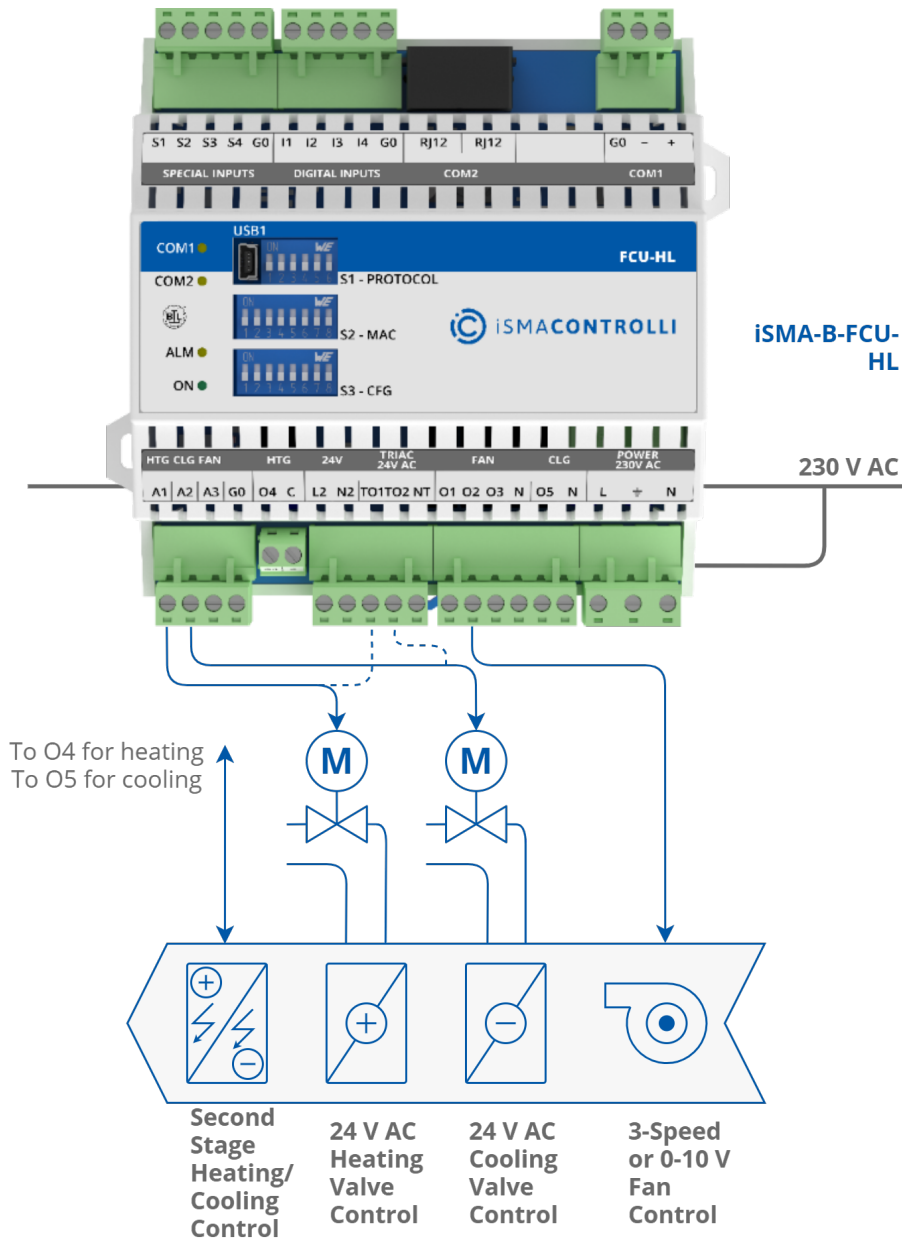
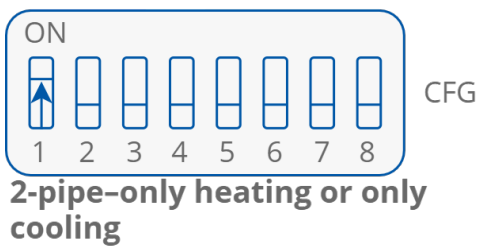


Figure 3. 4-pipe FCU installation

3.4.2 2-Pipe Only Heating or Only Cooling



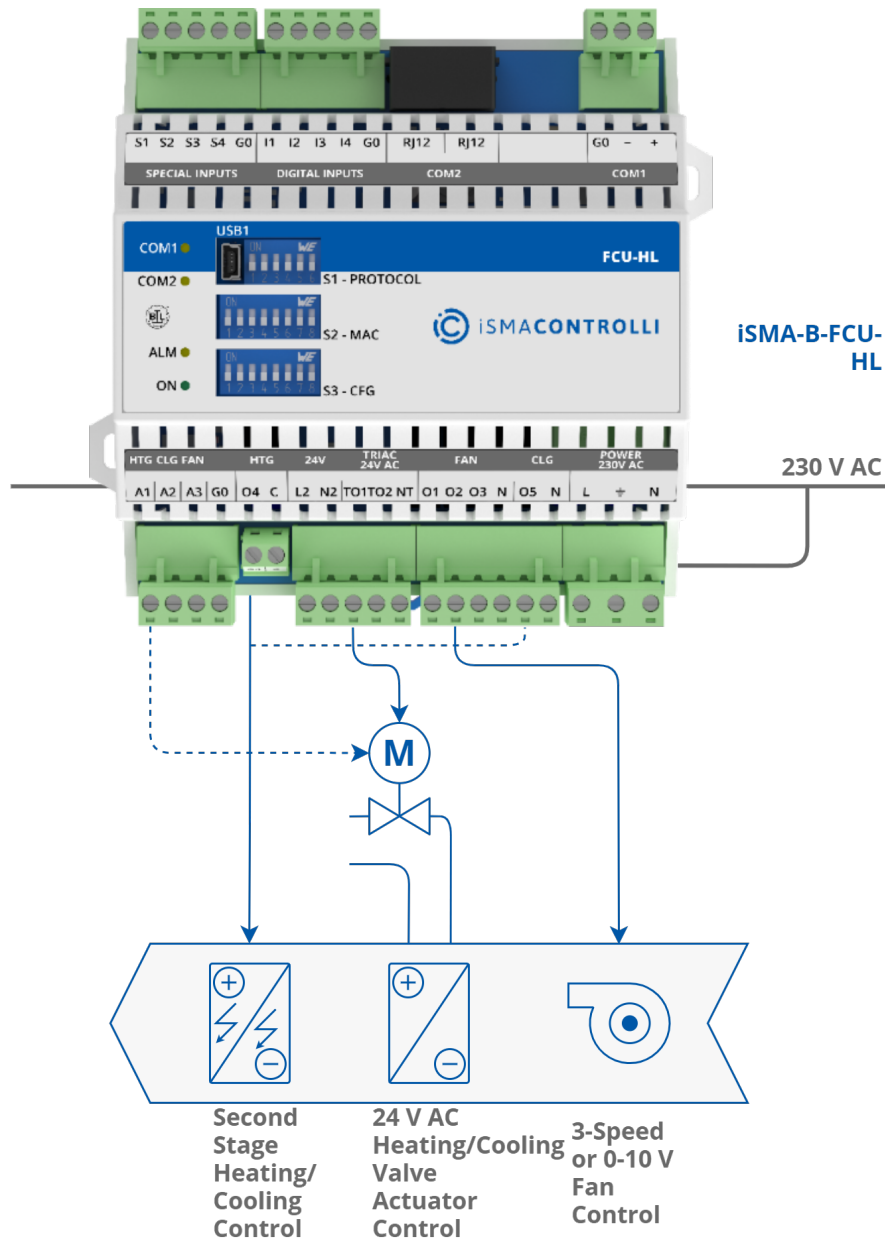


Figure 4. 2-pipe FCU installation

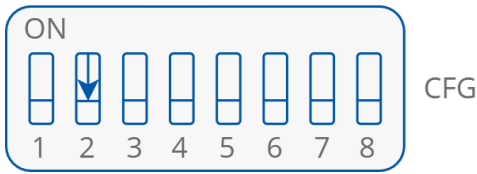
For connection details go to steps 6, 7, and 8.

For more information on configuring the FCU pipe types, check the iSMA-B-FCU Application manual.

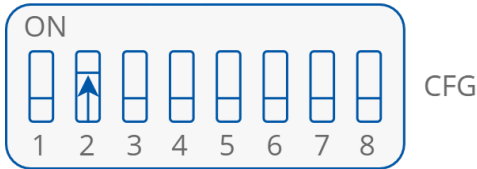
3.5 Step 4: Switching Between 1 Heating Stage and 2 Heating Stages Modes

The fan coil unit can operate with one heating device or with two heating devices. This needs to be configured with the 2nd section of the CFG DIP switch.

3.5.1 2 Stages of Heating in 4-Pipe Fan Coil Unit



1 stage heating = 1 heating device



2 stage heating = 2 separate heating devices

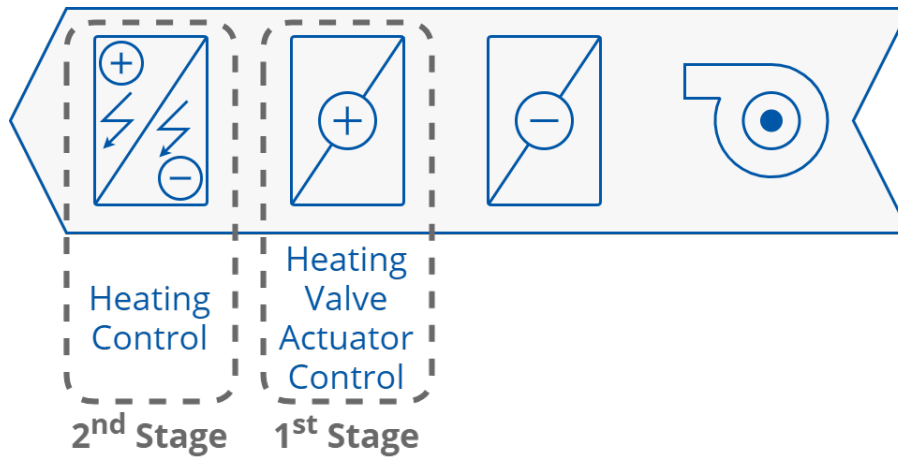


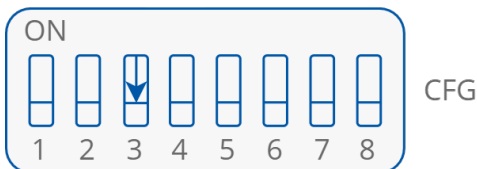
Figure 5. 2 stages of heating in 4-pipe FCU installation

For more information on configuring stages of heating, check the iSMA-B-FCU Application manual.

3.6 Step 5: Switching Between 1 Cooling Stage and 2 Cooling Stages Modes

The fan coil unit can operate with one cooling device or with two cooling devices. This needs to be configured with the 3rd DIP switch CFG.

3.6.1 2 Stages of Cooling in 4-Pipe Fan Coil Unit



1 stage cooling = 1 cooling device

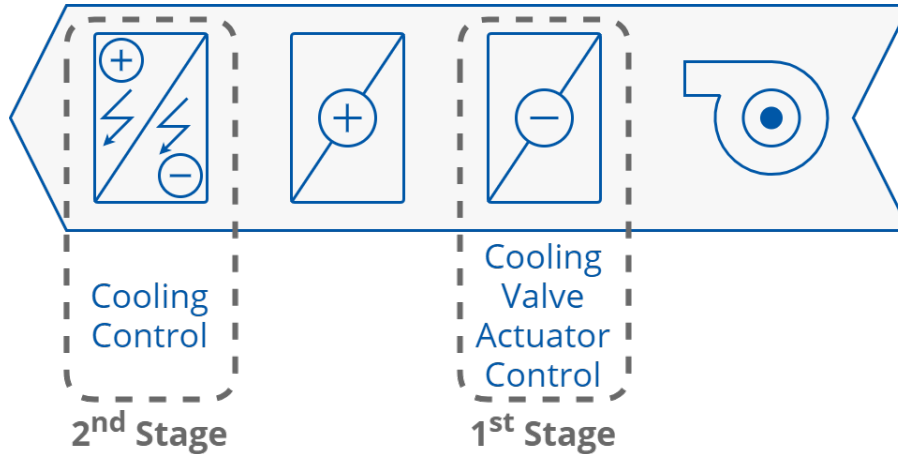
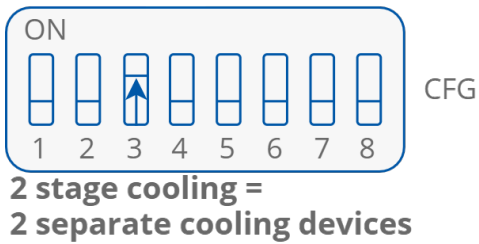
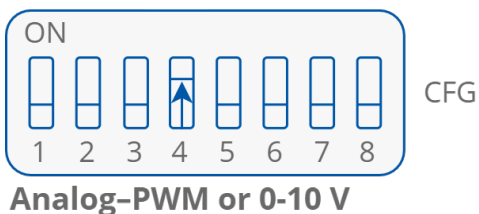
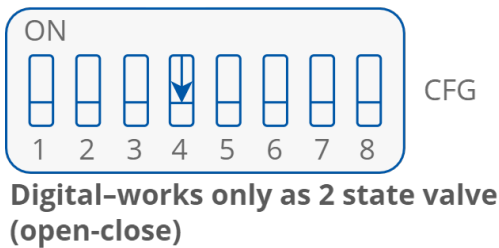


Figure 6. 2 stages of cooling in 2-pipe FCU installation

For more information on configuring stages of cooling, check the iSMA-B-FCU Application manual.

3.7 Step 6: Selecting Type of Control Required by the FCU Valves and Connection Details

The figure belowThe controller's outputs can operate in digital or analog mode. Depending on the fan coil unit actuators control type, the corresponding DIP switch has to be set to a desired position.



The figure below pictures the connection of heating actuators:

- A1 for analog 0-10 V control;
- TO1 for analog PWM or digital ON-OFF control;
- O4 for digital ON-OFF control.

Note that, when using the second stage heating, the additional second stage heater can be controlled only by the O4 output, leaving the A1 or TO1 for the first stage. Otherwise, when using only the first stage heating, the O4 output can be used for digital control of the first stage heating actuator.

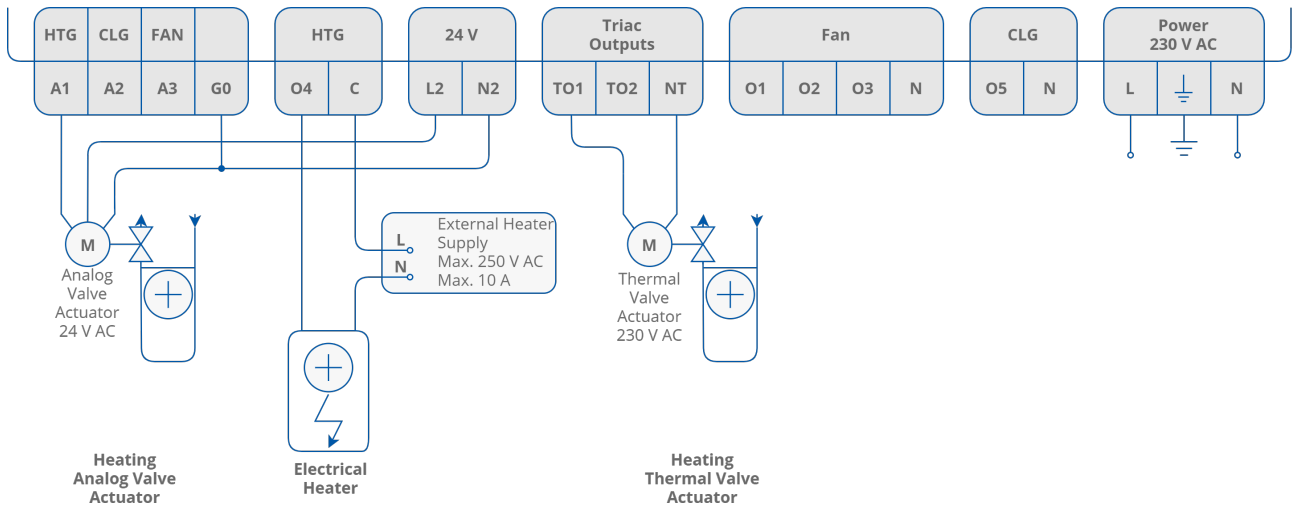


Figure 7. Heating actuators connection

The figure below pictures the connection of cooling actuators:

- A1 for analog 0-10 V control while operating in 2-pipe mode;
- A2 for analog 0-10 V control while operating in 4-pipe mode;
- TO1 for analog PWM or digital ON-OFF control while operating in 2-pipe mode;
- TO2 for analog PWM or digital ON-OFF control while operating in 4-pipe mode;
- O5 for digital ON-OFF control.

Note that, when using the second stage cooling, the additional second stage cooler can be controlled only by the O5 output, leaving the A1, A2, TO1, or TO2 for the first stage. Otherwise, when using only the first stage cooling, the O5 output can be used for digital control of the first stage cooling actuator.

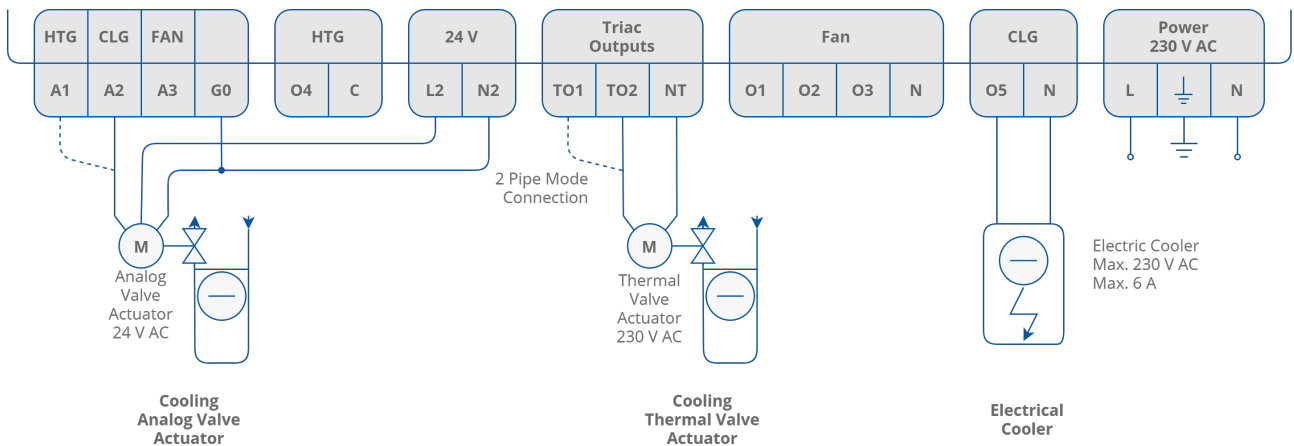


Figure 8. Cooling actuators connection

For more information on control types and connection details, check the iSMA-B-FCU Application manual and iSMA-B-FCU Hardware manual.

3.8 Step 7: Selecting the Temperature Control Value Source and its Connection Details

The temperature control value source has to be specified with the DIP switches 5 and 6. By default, the sensor's type, served by the controller's inputs S1 and S3, is the 10K3A1 NTC.

The temperature sensor type can be changed using the iSMA Tool software.

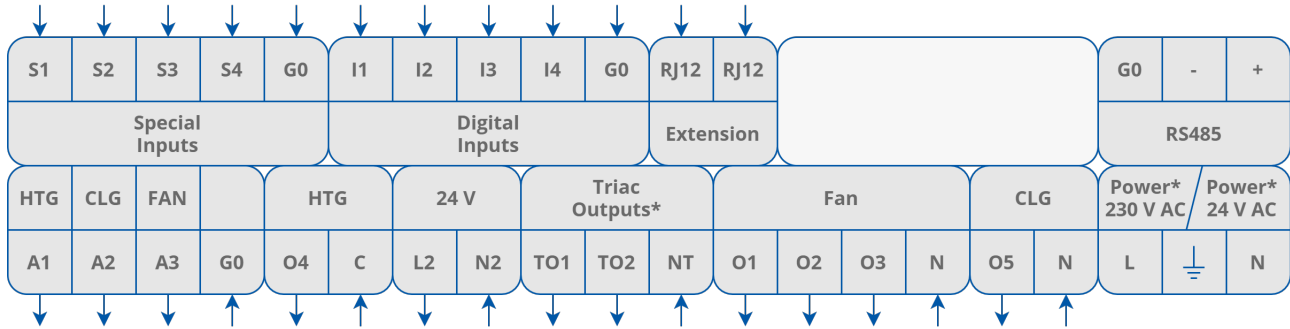


Figure 9. FCU connectors

3.8.1 Temperature Source: iSMA-B-LP/Touch Point/FP Room Panel

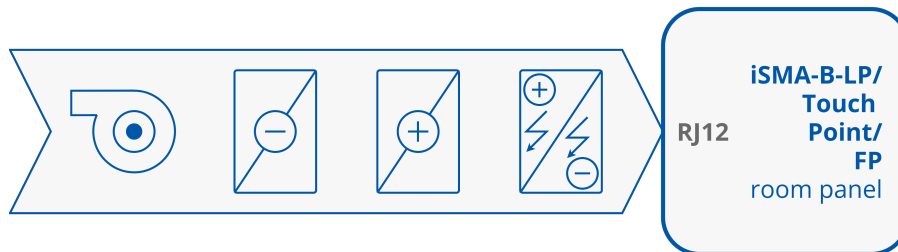
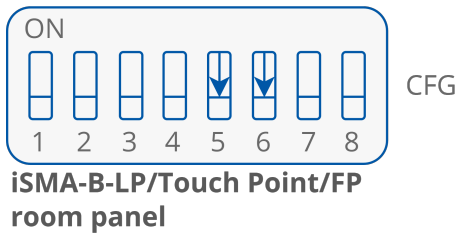
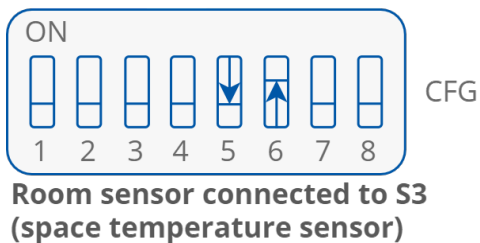


Figure 10. The LP/Touch Point room panel set as a temperature source

3.8.2 Temperature Source Connected to S3



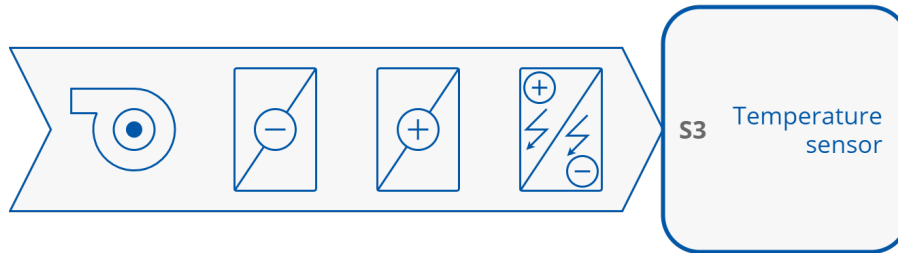
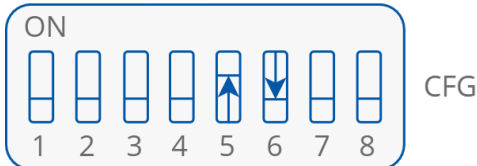


Figure 11. Temperature sensor connected to S3 as a temperature control value source

3.8.3 Temperature Source Connected to S1



Returning air temperature sensor connected to S1

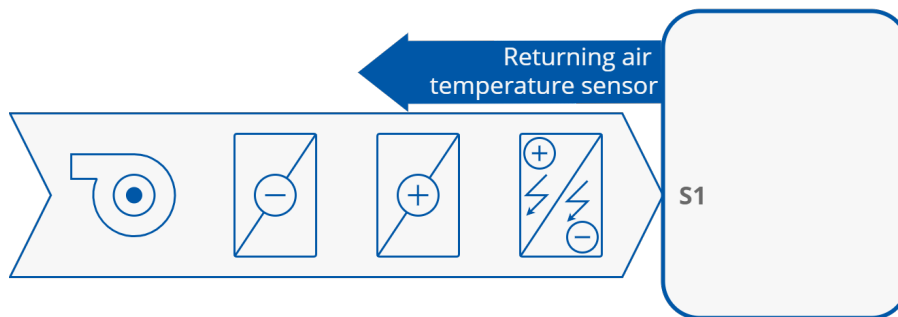


Figure 12. Returning air temperature sensor connected to S1

3.8.4 Temperature Source Connected to RS485 Network



Temperature received from the Modbus network (Holding register 106)

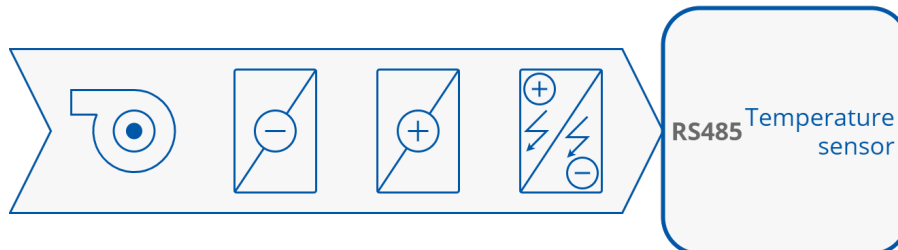


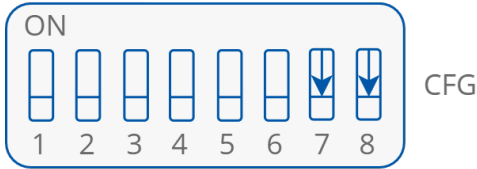
Figure 13. Temperature control value source set to the RS485 network

For more information, check the iSMA-B-FCU Application manual and iSMA-B-FCU Hardware manual.

3.9 Step 8: Selecting Type of Fan Used Within the Project and its Connection Details

There are many fan types the iSMA-B-FCU supports, and it can be configured for the fan coil unit used in the project.

3.9.1 Analog Controlled Fan Connection



Analog controlled fan

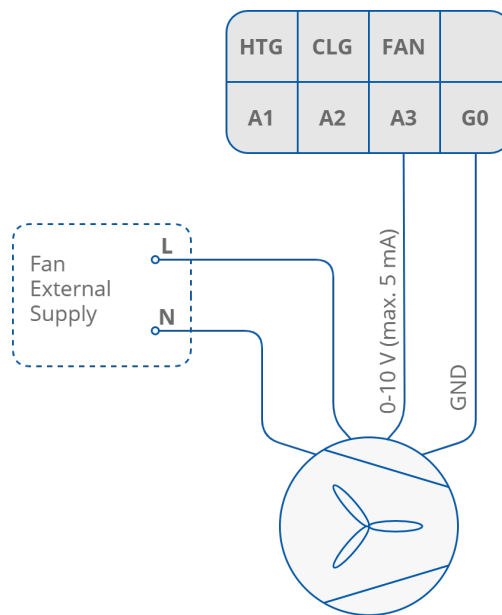


Figure 14. Analog controlled fan connection

3.9.2 1 Speed Fan Connection



1 Speed Fan

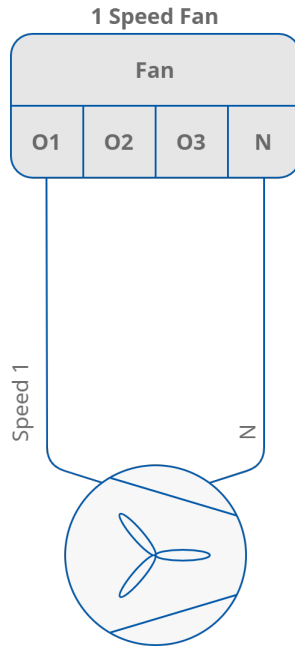
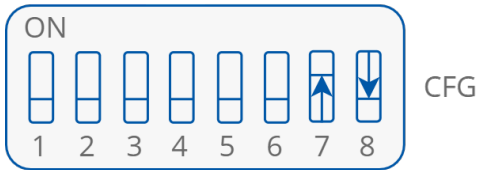


Figure 15. 1 speed fan connection

3.9.3 2 Speeds Fan Connection



2 Speeds Fan

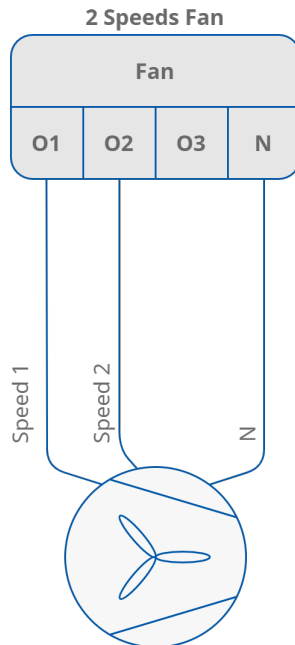
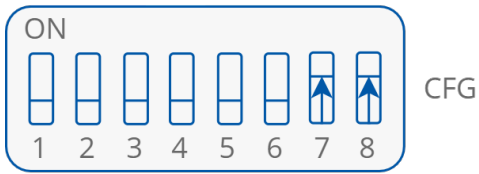


Figure 16. 2 speeds fan connection

3.9.4 3 Speeds Fan Connection



3 Speeds Fan

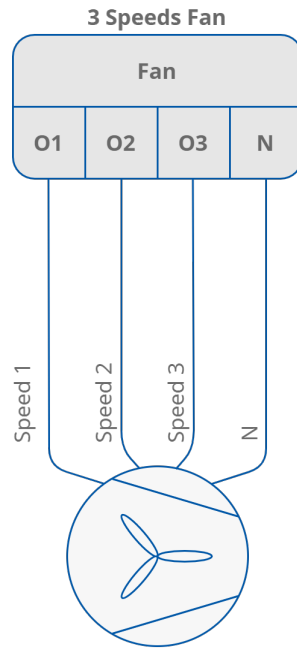


Figure 17. 3 speeds fan connection

4 Examples: Connecting Actuators and Sensors to the Controller

4.1 Connections Overview

S1	S2	S3	S4	G0	I1	I2	I3	I4	G0	RJ12	RJ12					G0	-	+	
Special Inputs				Digital Inputs						Extension		RS485							
HTG	CLG	FAN		HTG		24 V		Triac Outputs*			Fan			CLG		Power* 230 V AC	Power* 24 V AC		
A1	A2	A3	G0	O4	C	L2	N2	TO1	TO2	NT	O1	O2	O3	N	O5	N	L	⏏	N

Figure 18. Inputs and outputs overview

4.2 Connection Examples

The examples below do not include selection of the temperature control value source. Connecting the temperature control value source is described in Step 7 of this manual. In examples, DIP switch sections 5 and 6 are set to OFF.

The 24 V power source for heater and cooler actuators can be taken from L2/N2 connectors.

If 2nd stages of heating or cooling is used, check Step 6 for connection information.

4.2.1 4-Pipe Installation with 1 Stage Digital Controlled Heating and Cooling and Analog Controlled Fan

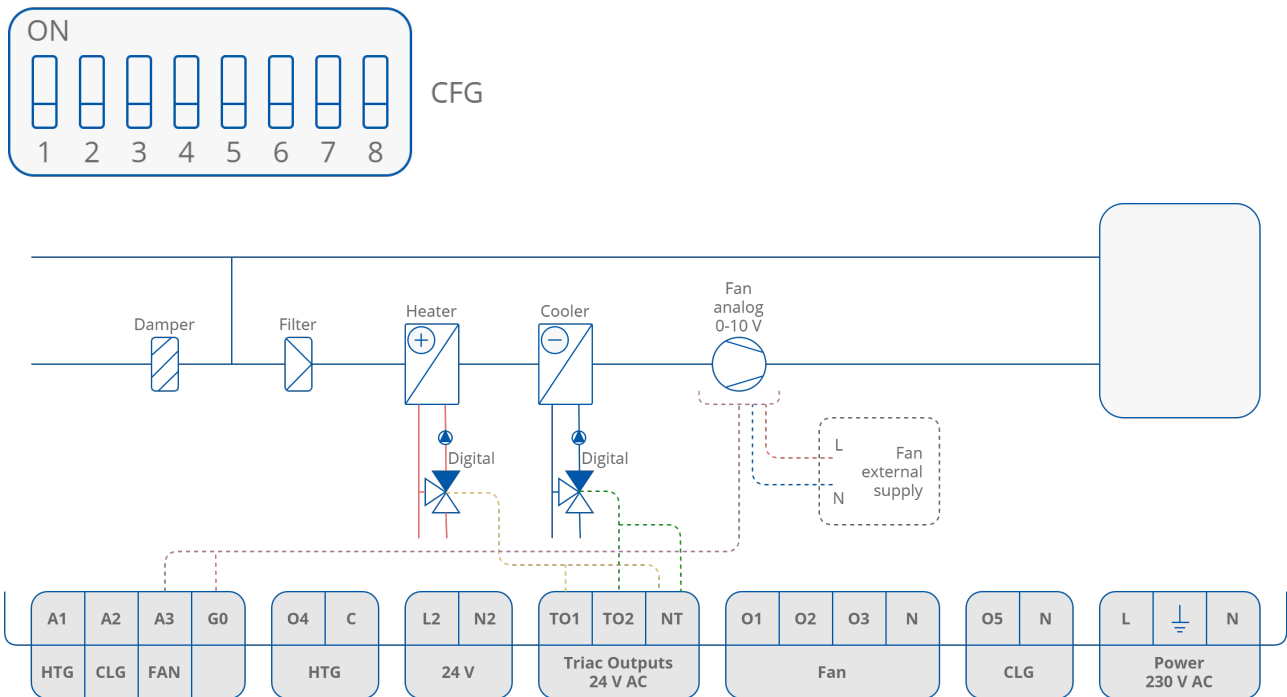


Figure 19. 4-pipe installation with 1 stage digital controlled heating and cooling and analog controlled fan

4.2.2 4-Pipe Installation with 1 Stage Digital Controlled Heating and Cooling and 1 Speed Fan

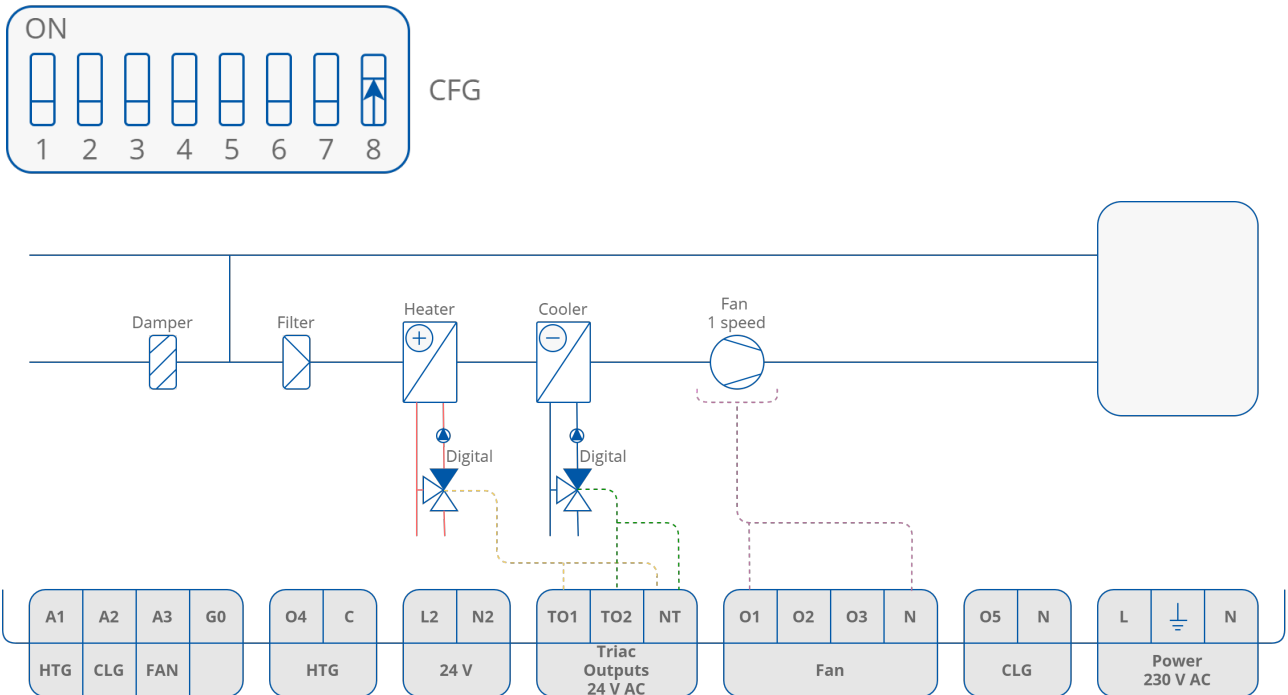


Figure 20. 4-pipe installation with 1 stage digital controlled heating and cooling and 1 speed fan

4.2.3 4-Pipe Installation with 1 Stage Digital Controlled Heating and Cooling and 2 Speeds Fan

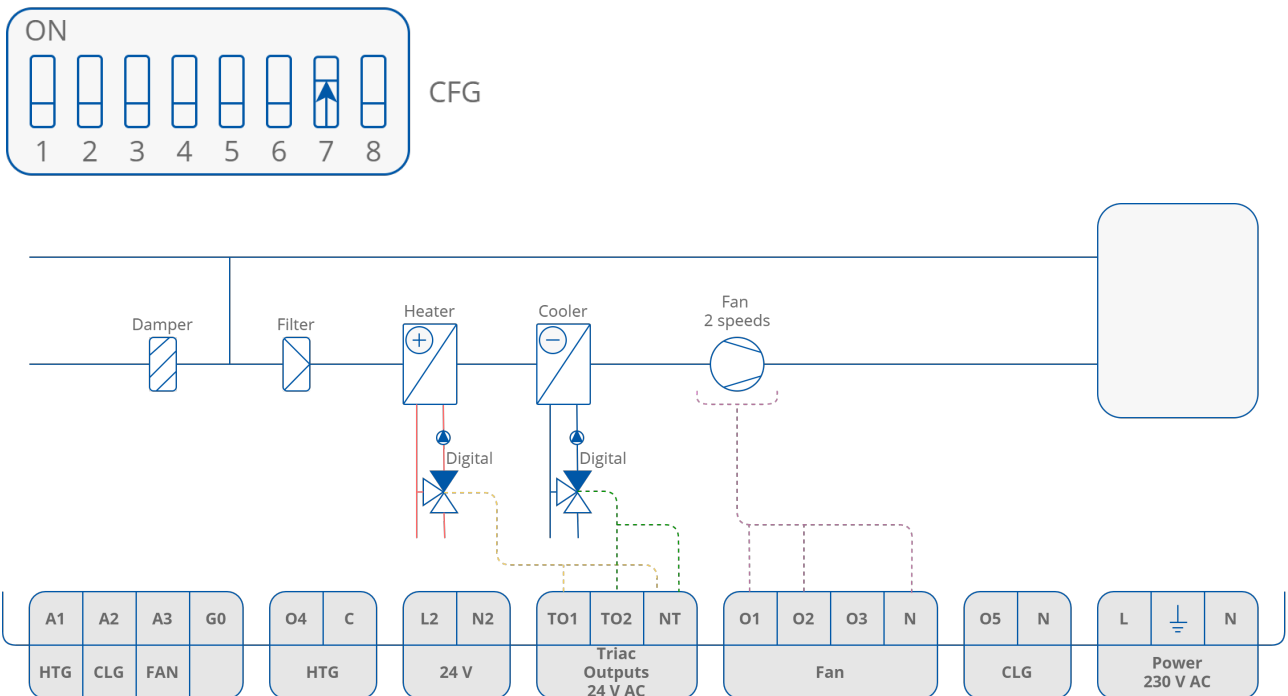


Figure 21. 4-pipe installation with 1 stage digital controlled heating and cooling and 2 speeds fan

4.2.4 4-Pipe Installation with 1 Stage Digital Controlled Heating and Cooling and 3 Speeds Fan

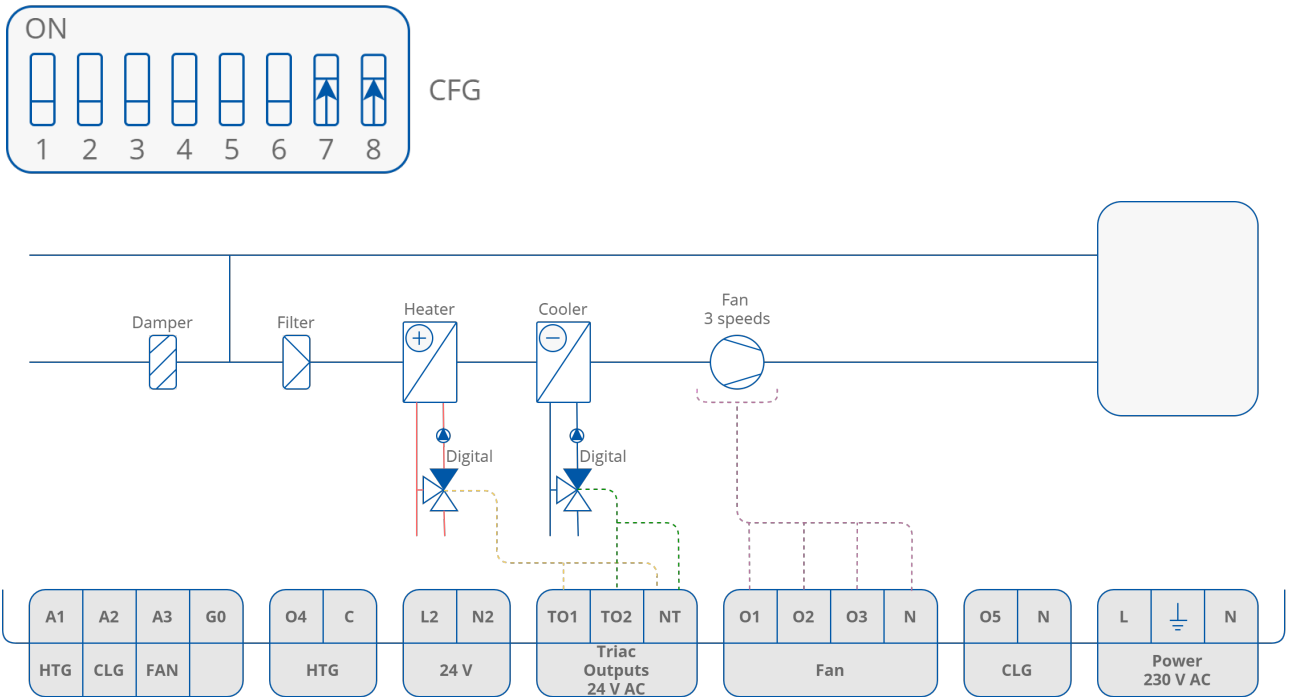


Figure 22. 4-pipe installation with 1 stage digital controlled heating and cooling and 3 speeds fan

4.2.5 4-Pipe Installation with 1 Stage Analog Controlled Heating and Cooling and Analog Controlled Fan

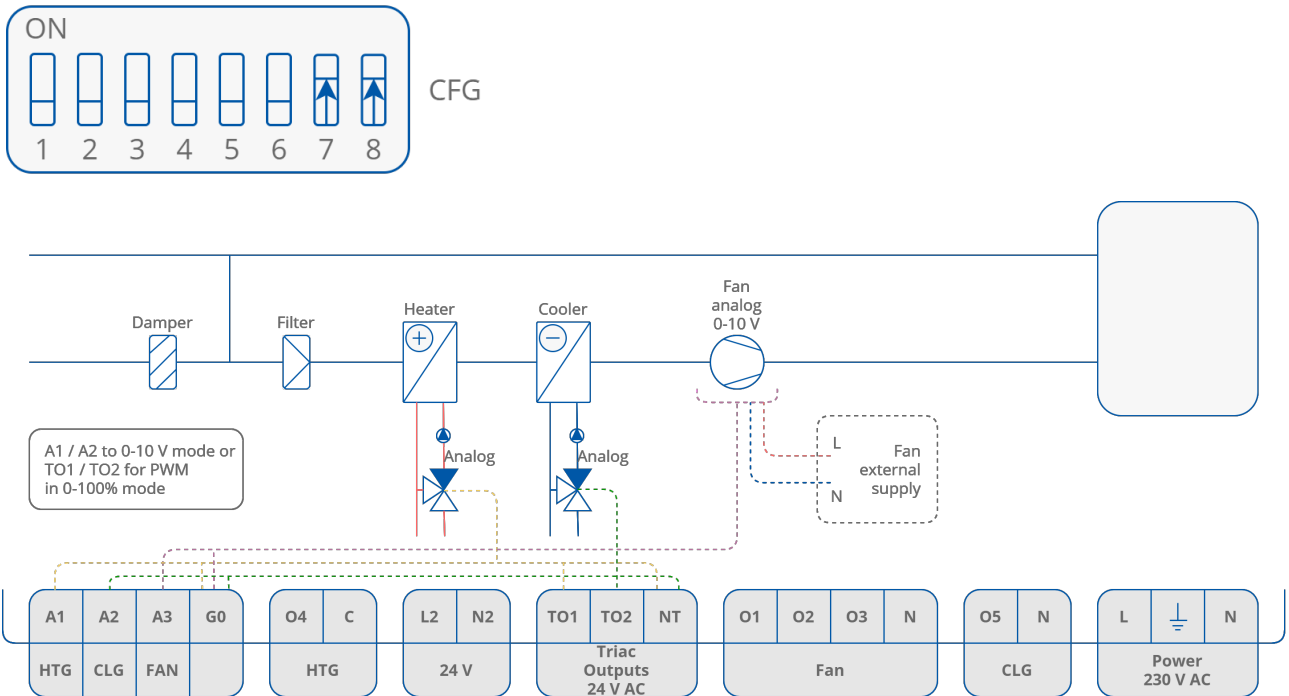


Figure 23. 4-pipe installation with 1 stage analog controlled heating and cooling and analog controlled fan

4.2.6 4-Pipe Installation with 1 Stage Analog Controlled Heating and Cooling and 1 Speed Fan

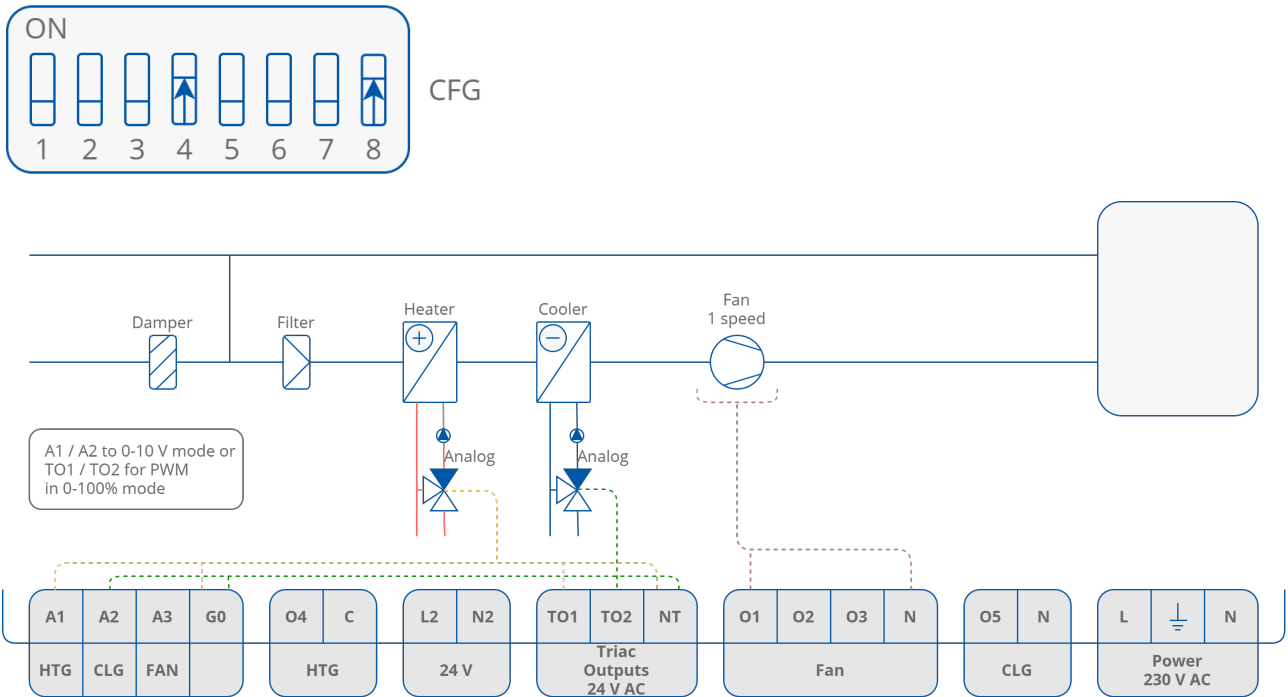


Figure 24. 4-pipe installation with 1 stage analog controlled heating and cooling and 1 speed fan

4.2.7 4-Pipe Installation with 1 Stage Analog Controlled Heating and Cooling and 2 Speeds Fan

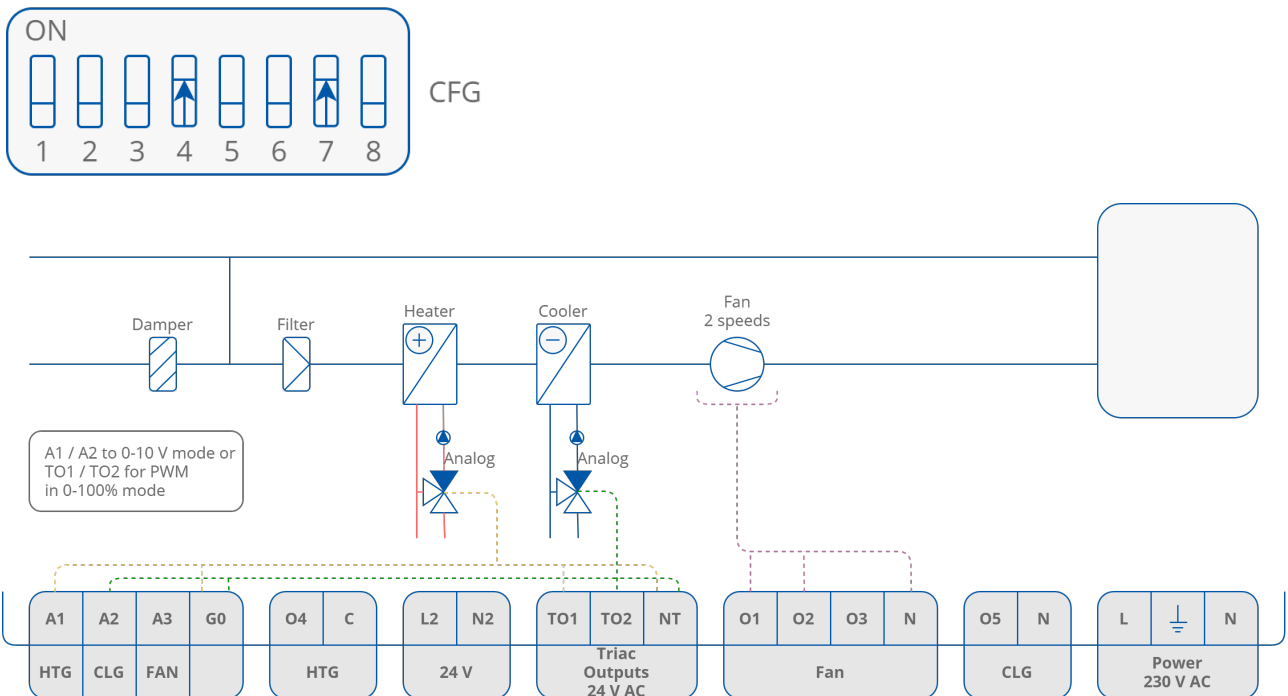


Figure 25. 4-pipe installation with 1 stage analog controlled heating and cooling and 2 speeds fan

4.2.8 4-Pipe Installation with 1 Stage Analog Controlled Heating and Cooling and 3 Speeds Fan

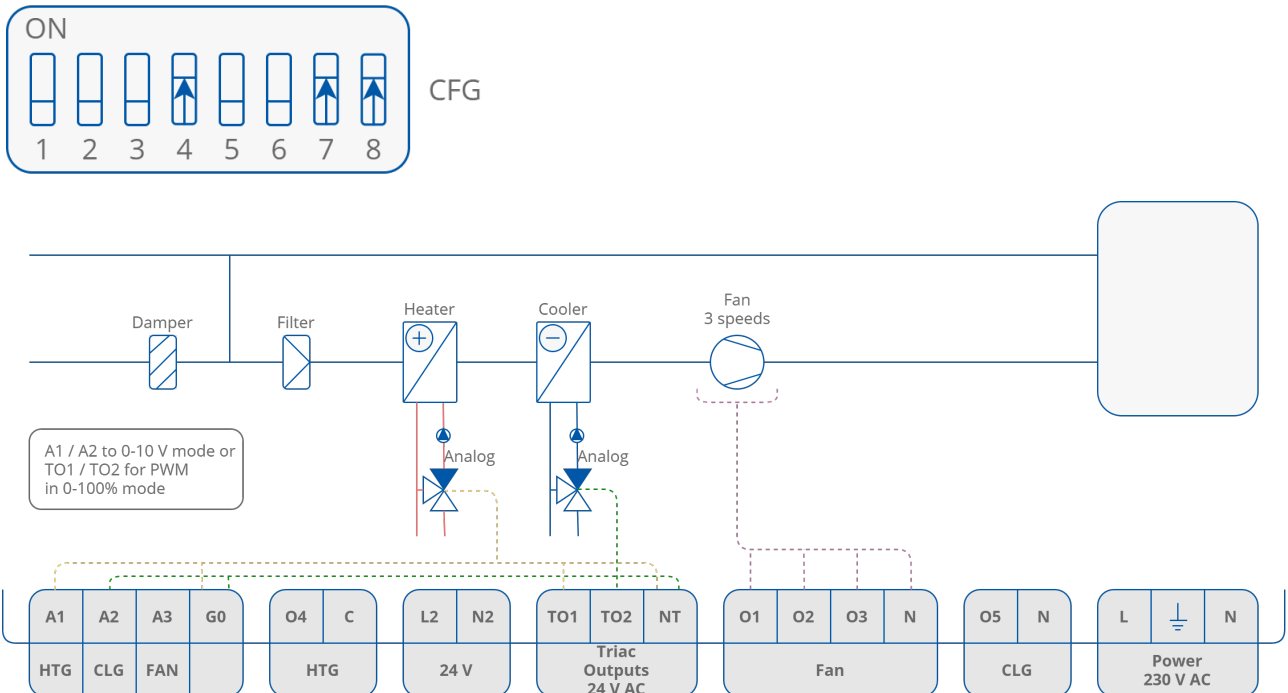


Figure 26. 4-pipe installation with 1 stage analog controlled heating and cooling and 3 speeds fan

4.2.9 2-Pipe Installation with 1 Stage Digital Controlled Cooling and Analog Controlled Fan

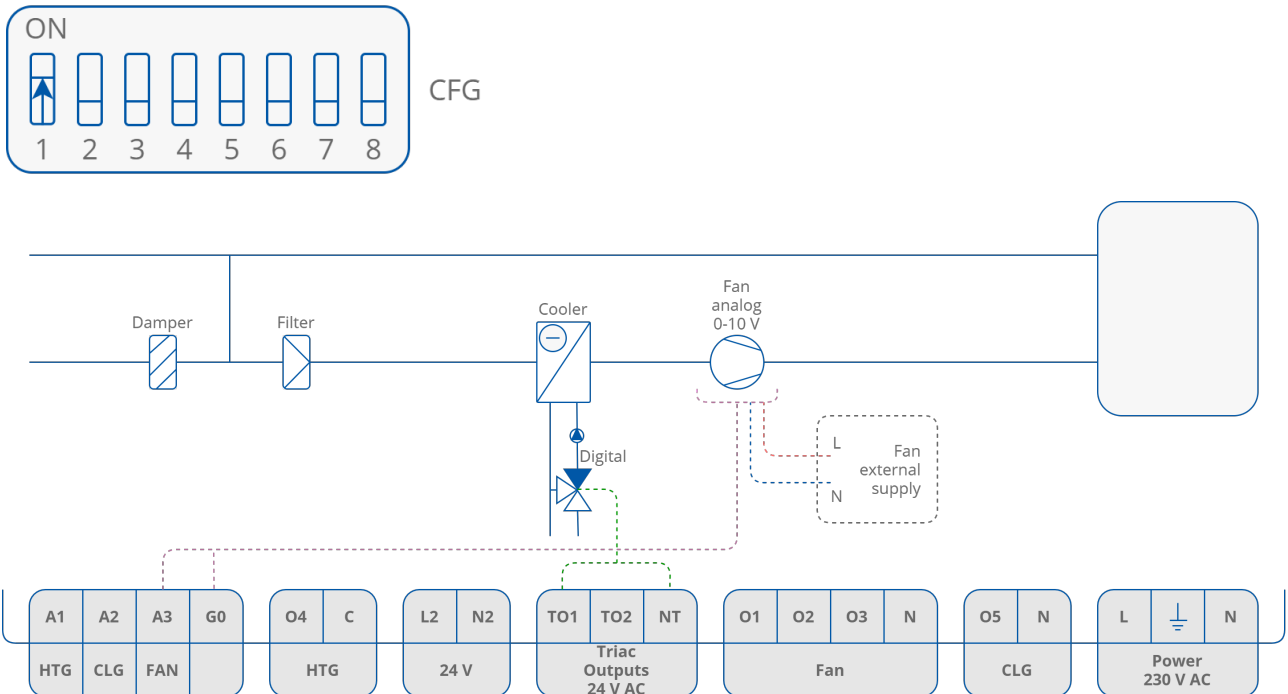


Figure 27. 2-pipe installation with 1 stage digital controlled cooling and analog controlled fan

4.2.10 2-Pipe Installation with 1 Stage Digital Controlled Heating and 1 Speed Fan

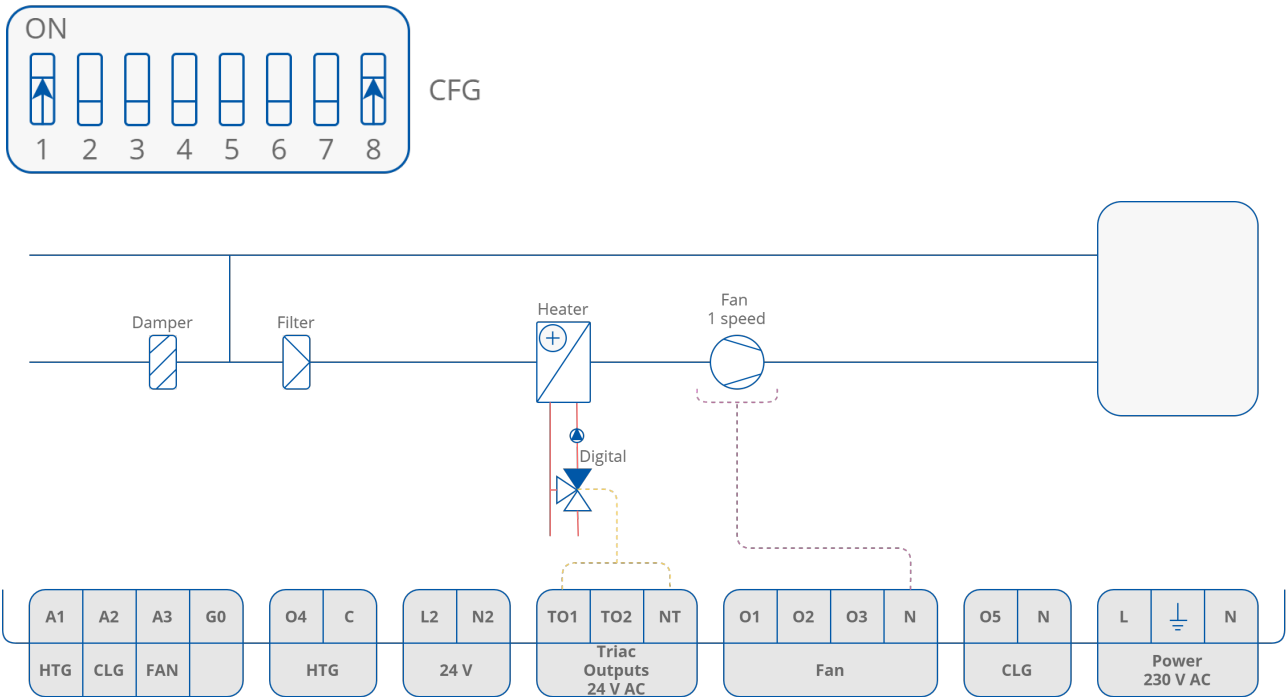


Figure 28. 2-pipe installation with 1 stage digital controlled heating and 1 speed fan

4.2.11 2-Pipe Installation with 1 Stage Digital Controlled Cooling and 2 Speeds Fan

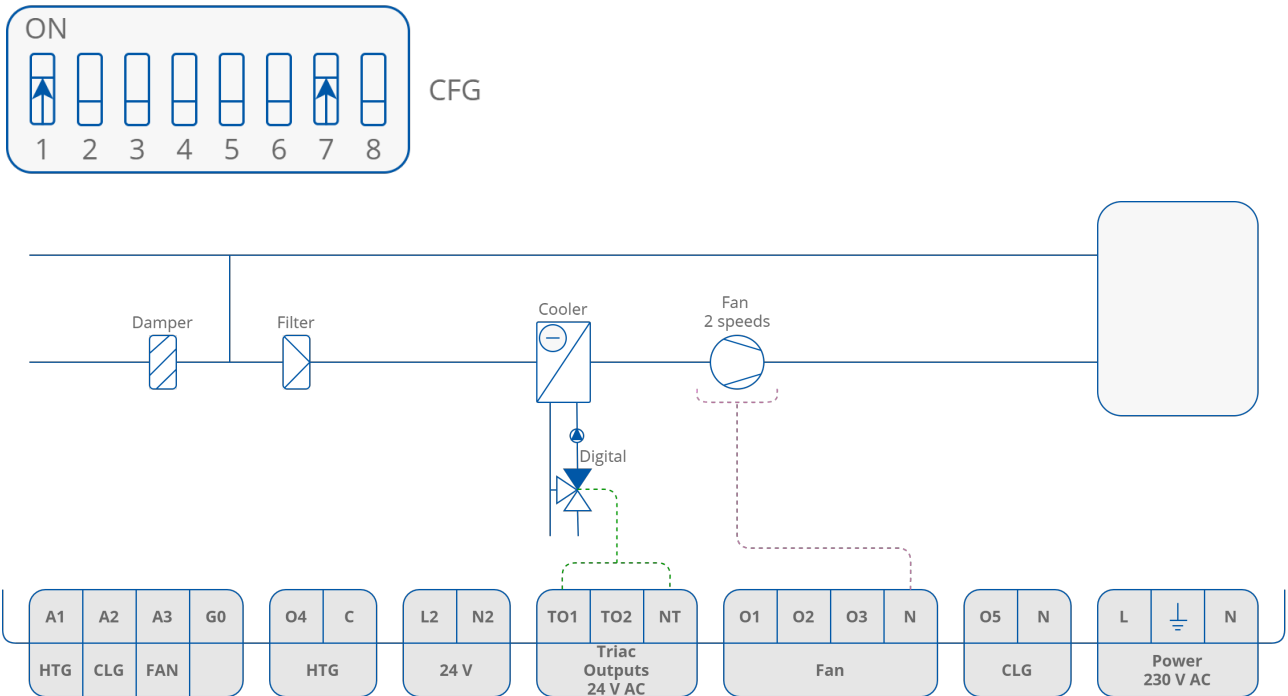


Figure 29. 2-pipe installation with 1 stage digital controlled cooling and 2 speeds fan

4.2.12 2-Pipe Installation with 1 Stage Digital Controlled Heating and 3 Speeds Fan

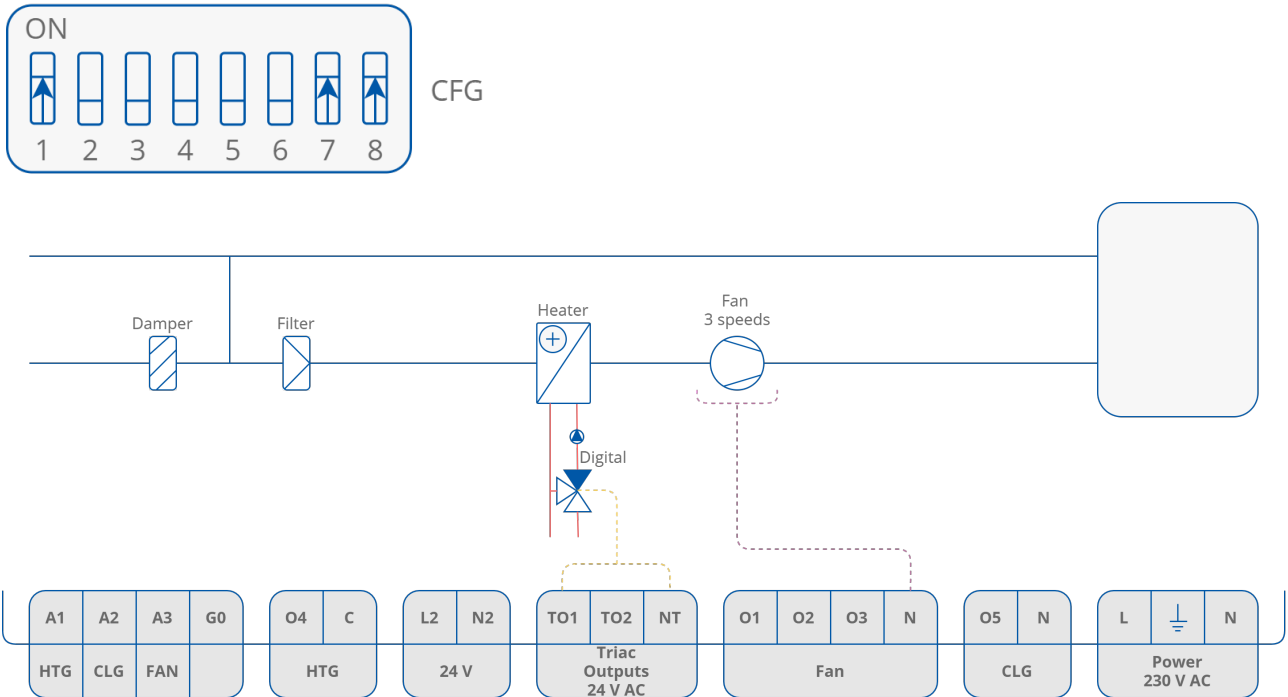


Figure 30. 2-pipe installation with 1 stage digital controlled heating and 3 speeds fan

4.2.13 2-Pipe Installation with 1 Stage Analog Controlled Cooling and Analog Controlled Fan

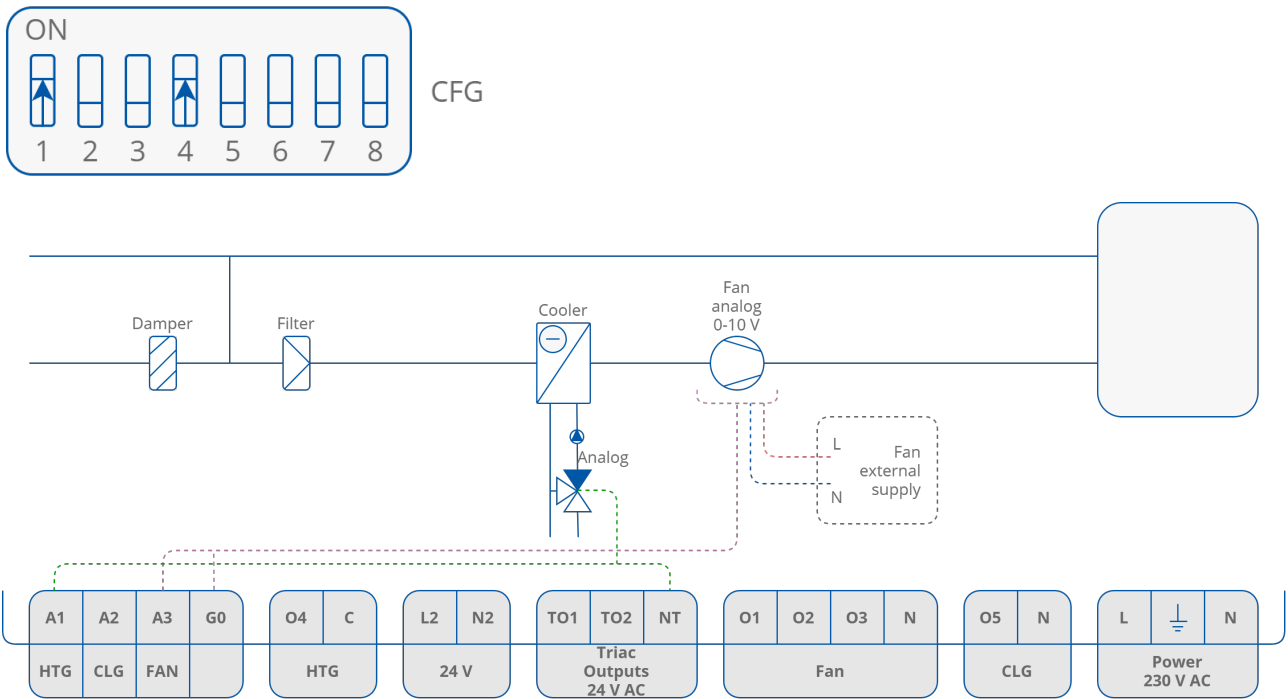


Figure 31. 2-pipe installation with 1 stage analog controlled cooling and analog controlled fan

4.2.14 2-Pipe Installation with 1 Stage Analog Controlled Heating and 1 Speed Fan

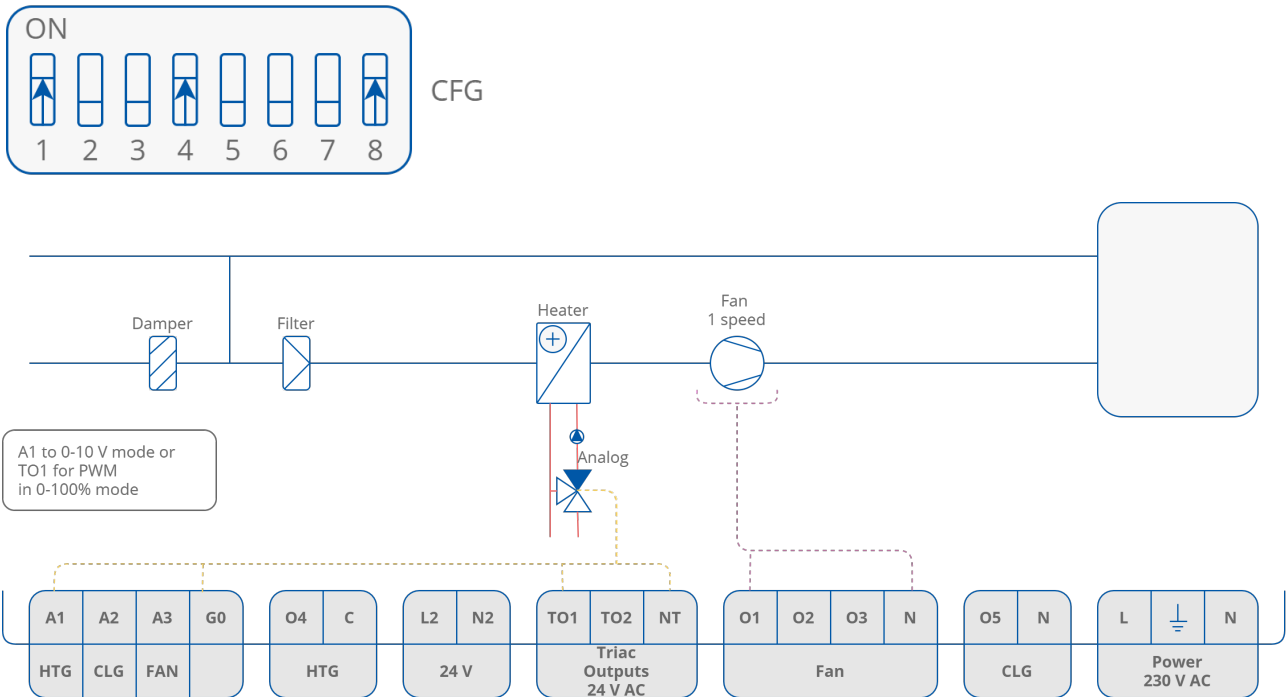


Figure 32. 2-pipe installation with 1 stage analog controlled heating and 1 speed fan

4.2.15 2-Pipe Installation with 1 Stage Analog Controlled Cooling and 2 Speeds Fan

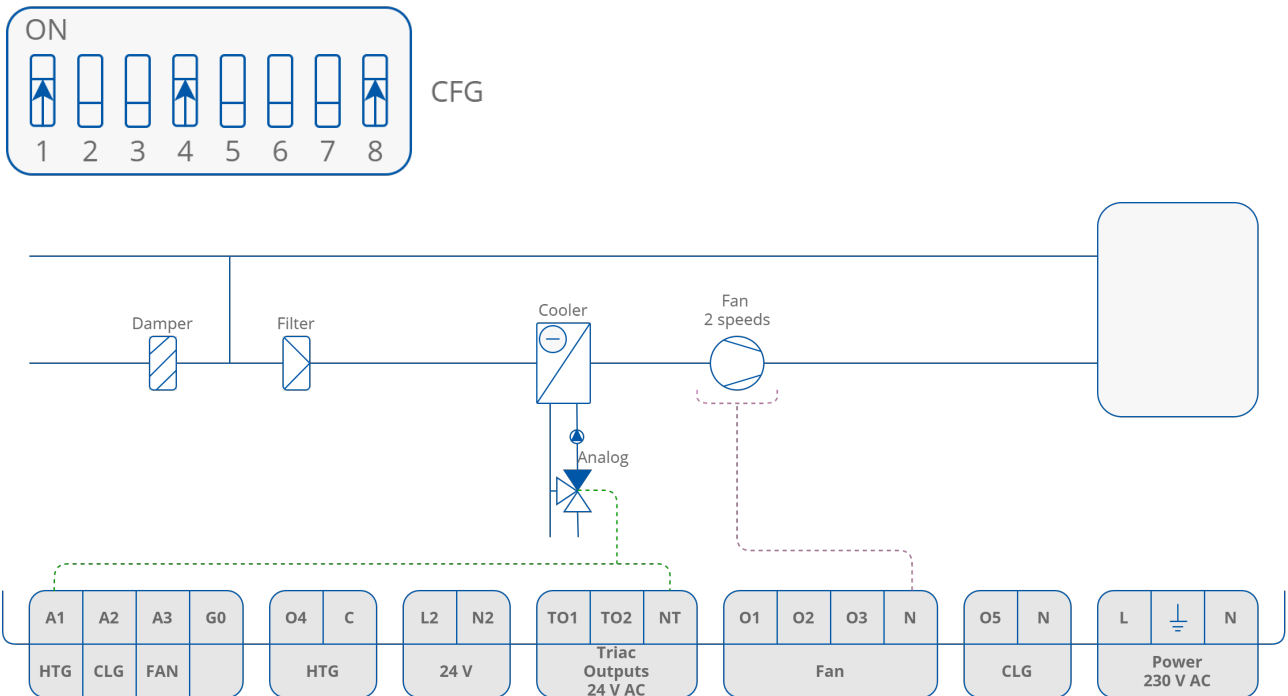


Figure 33. 2-pipe installation with 1 stage analog controlled cooling and 2 speeds fan

4.2.16 2-Pipe Installation with 1 Stage Analog Controlled Heating and 3 Speeds Fan

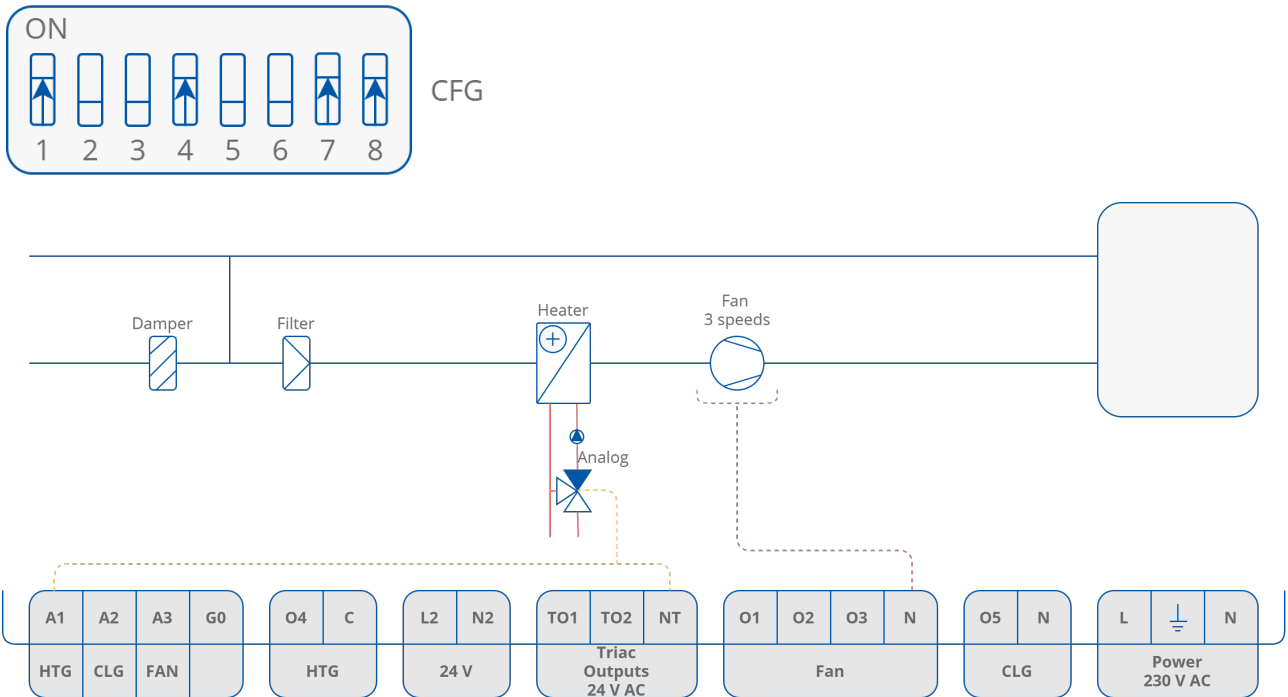
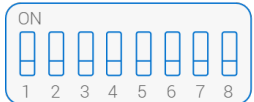














Figure 34. 2-pipe installation with 1 stage analog controlled heating and 3 speeds fan




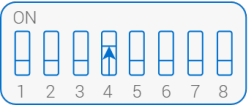





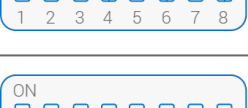
5 All Configurations for FCU Default Application

DIP Switch	5	6	7	8	Setting
Temp. source	OFF	OFF			iSMA-B-LP/Touch Point/FP room panel
	OFF	ON			Room sensor (SI3)
	ON	OFF			Returning air temperature sensor (SI1)
	ON	ON			Temperature from Modbus network
Fan			OFF	OFF	Analog control
			OFF	ON	1 speed
			ON	OFF	2 speeds
			ON	ON	3 speeds


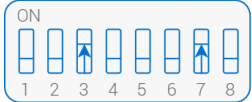








Table 7. DIP switch settings for selecting a temperature source and fan type






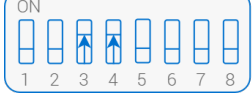



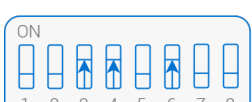
DIP Switch	1	2	3	4	5 & 6	7 & 8	
Function	FCU Pipe Mode	Heating	Cooling	Control	Temperature source	Fan	
	Off (4-pipe) On (2-pipe)	Off (1-stage) On (2-stage)	Off (1-stage) On (2-stage)	Off (digital) On (analog)	For configuration see table above	For configuration see table above	
1	4-pipe	1-stage heating	1-stage cooling	Digital control	iSMA-B-LP/Touch Point/FP room panel	Analog control	
2	4-pipe	1-stage heating	1-stage cooling	Digital control	iSMA-B-LP/Touch Point/FP room panel	1 speed	
3	4-pipe	1-stage heating	1-stage cooling	Digital control	iSMA-B-LP/Touch Point/FP room panel	2 speeds	

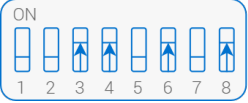
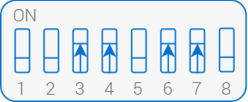

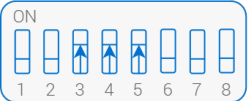
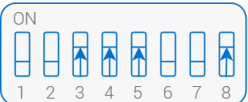


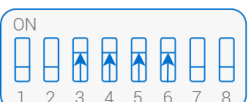
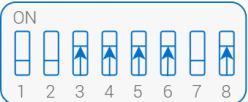

DIP Switch	1	2	3	4	5 & 6	7 & 8	
4	4-pipe	1-stage heating	1-stage cooling	Digital control	iSMA-B-LP/Touch Point/FP room panel	3 speeds	 CFG
5	4-pipe	1-stage heating	1-stage cooling	Digital control	Room sensor (SI3)	Analog control	 CFG
6	4-pipe	1-stage heating	1-stage cooling	Digital control	Room sensor (SI3)	1 speed	 CFG
7	4-pipe	1-stage heating	1-stage cooling	Digital control	Room sensor (SI3)	2 speeds	 CFG
8	4-pipe	1-stage heating	1-stage cooling	Digital control	Room sensor (SI3)	3 speeds	 CFG
9	4-pipe	1-stage heating	1-stage cooling	Digital control	Returning air temperature sensor (SI1)	Analog control	 CFG
10	4-pipe	1-stage heating	1-stage cooling	Digital control	Returning air temperature sensor (SI1)	1 speed	 CFG
11	4-pipe	1-stage heating	1-stage cooling	Digital control	Returning air temperature sensor (SI1)	2 speeds	 CFG
12	4-pipe	1-stage heating	1-stage cooling	Digital control	Returning air temperature sensor (SI1)	3 speeds	 CFG
13	4-pipe	1-stage heating	1-stage cooling	Digital control	Temperature from Modbus network	Analog control	 CFG










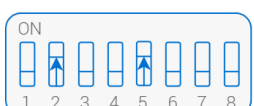
DIP Switch	1	2	3	4	5 & 6	7 & 8	
14	4-pipe	1-stage heating	1-stage cooling	Digital control	Temperature from Modbus network	1 speed	 CFG
15	4-pipe	1-stage heating	1-stage cooling	Digital control	Temperature from Modbus network	2 speeds	 CFG
16	4-pipe	1-stage heating	1-stage cooling	Digital control	Temperature from Modbus network	3 speeds	 CFG
17	4-pipe	1-stage heating	1-stage cooling	Analog control	iSMA-B-LP/Touch Point/FP room panel	Analog control	 CFG
18	4-pipe	1-stage heating	1-stage cooling	Analog control	iSMA-B-LP/Touch Point/FP room panel	1 speed	 CFG
19	4-pipe	1-stage heating	1-stage cooling	Analog control	iSMA-B-LP/Touch Point/FP room panel	2 speeds	 CFG
20	4-pipe	1-stage heating	1-stage cooling	Analog control	iSMA-B-LP/Touch Point/FP room panel	3 speeds	 CFG
21	4-pipe	1-stage heating	1-stage cooling	Analog control	Room sensor (SI3)	Analog control	 CFG
22	4-pipe	1-stage heating	1-stage cooling	Analog control	Room sensor (SI3)	1 speed	 CFG
23	4-pipe	1-stage heating	1-stage cooling	Analog control	Room sensor (SI3)	2 speeds	 CFG






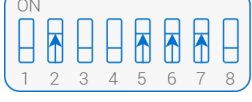




DIP Switch	1	2	3	4	5 & 6	7 & 8	
24	4-pipe	1-stage heating	1-stage cooling	Analog control	Room sensor (S13)	3 speeds	<p>ON 1 2 3 4 5 6 7 8 CFG</p>
25	4-pipe	1-stage heating	1-stage cooling	Analog control	Returning air temperature sensor (S1)	Analog control	<p>ON 1 2 3 4 5 6 7 8 CFG</p>
26	4-pipe	1-stage heating	1-stage cooling	Analog control	Returning air temperature sensor (S1)	1 speed	<p>ON 1 2 3 4 5 6 7 8 CFG</p>
27	4-pipe	1-stage heating	1-stage cooling	Analog control	Returning air temperature sensor (S1)	2 speeds	<p>ON 1 2 3 4 5 6 7 8 CFG</p>
28	4-pipe	1-stage heating	1-stage cooling	Analog control	Returning air temperature sensor (S1)	3 speeds	<p>ON 1 2 3 4 5 6 7 8 CFG</p>
29	4-pipe	1-stage heating	1-stage cooling	Analog control	Temperature from Modbus network	Analog control	<p>ON 1 2 3 4 5 6 7 8 CFG</p>
30	4-pipe	1-stage heating	1-stage cooling	Analog control	Temperature from Modbus network	1 speed	<p>ON 1 2 3 4 5 6 7 8 CFG</p>
31	4-pipe	1-stage heating	1-stage cooling	Analog control	Temperature from Modbus network	2 speeds	<p>ON 1 2 3 4 5 6 7 8 CFG</p>
32	4-pipe	1-stage heating	1-stage cooling	Analog control	Temperature from Modbus network	3 speeds	<p>ON 1 2 3 4 5 6 7 8 CFG</p>
33	4-pipe	1-stage heating	2-stage cooling	Digital control	iSMA-B-LP/Touch Point/FP room panel	Analog control	<p>ON 1 2 3 4 5 6 7 8 CFG</p>




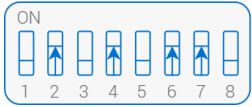






DIP Switch	1	2	3	4	5 & 6	7 & 8	
34	4-pipe	1-stage heating	2-stage cooling	Digital control	iSMA-B-LP/Touch Point/FP room panel	1 speed	 CFG
35	4-pipe	1-stage heating	2-stage cooling	Digital control	iSMA-B-LP/Touch Point/FP room panel	2 speeds	 CFG
36	4-pipe	1-stage heating	2-stage cooling	Digital control	iSMA-B-LP/Touch Point/FP room panel	3 speeds	 CFG
37	4-pipe	1-stage heating	2-stage cooling	Digital control	Room sensor (SI3)	Analog control	 CFG
38	4-pipe	1-stage heating	2-stage cooling	Digital control	Room sensor (SI3)	1 speed	 CFG
39	4-pipe	1-stage heating	2-stage cooling	Digital control	Room sensor (SI3)	2 speeds	 CFG
40	4-pipe	1-stage heating	2-stage cooling	Digital control	Room sensor (SI3)	3 speeds	 CFG
41	4-pipe	1-stage heating	2-stage cooling	Digital control	Returning air temperature sensor (SI1)	Analog control	 CFG
42	4-pipe	1-stage heating	2-stage cooling	Digital control	Returning air temperature sensor (SI1)	1 speed	 CFG
43	4-pipe	1-stage heating	2-stage cooling	Digital control	Returning air temperature sensor (SI1)	2 speeds	 CFG



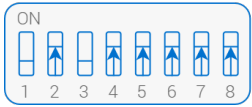
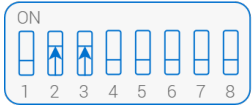

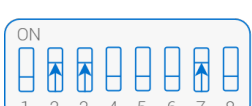




DIP Switch	1	2	3	4	5 & 6	7 & 8	
44	4-pipe	1-stage heating	2-stage cooling	Digital control	Returning air temperature sensor (S1)	3 speeds	
45	4-pipe	1-stage heating	2-stage cooling	Digital control	Temperature from Modbus network	Analog control	
46	4-pipe	1-stage heating	2-stage cooling	Digital control	Temperature from Modbus network	1 speed	
47	4-pipe	1-stage heating	2-stage cooling	Digital control	Temperature from Modbus network	2 speeds	
48	4-pipe	1-stage heating	2-stage cooling	Digital control	Temperature from Modbus network	3 speeds	
49	4-pipe	1-stage heating	2-stage cooling	Analog control	iSMA-B-LP/Touch Point/FP room panel	Analog control	
50	4-pipe	1-stage heating	2-stage cooling	Analog control	iSMA-B-LP/Touch Point/FP room panel	1 speed	
51	4-pipe	1-stage heating	2-stage cooling	Analog control	iSMA-B-LP/Touch Point/FP room panel	2 speeds	
52	4-pipe	1-stage heating	2-stage cooling	Analog control	iSMA-B-LP/Touch Point/FP room panel	3 speeds	
53	4-pipe	1-stage heating	2-stage cooling	Analog control	Room sensor (S13)	Analog control	




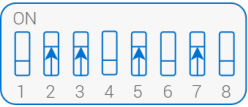



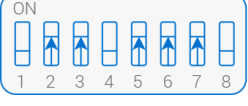


DIP Switch	1	2	3	4	5 & 6	7 & 8	
54	4-pipe	1-stage heating	2-stage cooling	Analog control	Room sensor (SI3)	1 speed	
55	4-pipe	1-stage heating	2-stage cooling	Analog control	Room sensor (SI3)	2 speeds	
56	4-pipe	1-stage heating	2-stage cooling	Analog control	Room sensor (SI3)	3 speeds	
57	4-pipe	1-stage heating	2-stage cooling	Analog control	Returning air temperature sensor (SI1)	Analog control	
58	4-pipe	1-stage heating	2-stage cooling	Analog control	Returning air temperature sensor (SI1)	1 speed	
59	4-pipe	1-stage heating	2-stage cooling	Analog control	Returning air temperature sensor (SI1)	2 speeds	
60	4-pipe	1-stage heating	2-stage cooling	Analog control	Returning air temperature sensor (SI1)	3 speeds	
61	4-pipe	1-stage heating	2-stage cooling	Analog control	Temperature from Modbus network	Analog control	
62	4-pipe	1-stage heating	2-stage cooling	Analog control	Temperature from Modbus network	1 speed	
63	4-pipe	1-stage heating	2-stage cooling	Analog control	Temperature from Modbus network	2 speeds	











DIP Switch	1	2	3	4	5 & 6	7 & 8	
64	4-pipe	1-stage heating	2-stage cooling	Analog control	Temperature from Modbus network	3 speeds	
65	4-pipe	2-stage heating	1-stage cooling	Digital control	iSMA-B-LP/Touch Point/FP room panel	Analog control	
66	4-pipe	2-stage heating	1-stage cooling	Digital control	iSMA-B-LP/Touch Point/FP room panel	1 speed	
67	4-pipe	2-stage heating	1-stage cooling	Digital control	iSMA-B-LP/Touch Point/FP room panel	2 speeds	
68	4-pipe	2-stage heating	1-stage cooling	Digital control	iSMA-B-LP/Touch Point/FP room panel	3 speeds	
69	4-pipe	2-stage heating	1-stage cooling	Digital control	Room sensor (SI3)	Analog control	
70	4-pipe	2-stage heating	1-stage cooling	Digital control	Room sensor (SI3)	1 speed	
71	4-pipe	2-stage heating	1-stage cooling	Digital control	Room sensor (SI3)	2 speeds	
72	4-pipe	2-stage heating	1-stage cooling	Digital control	Room sensor (SI3)	3 speeds	
73	4-pipe	2-stage heating	1-stage cooling	Digital control	Returning air temperature sensor (SI1)	Analog control	











DIP Switch	1	2	3	4	5 & 6	7 & 8	
74	4-pipe	2-stage heating	1-stage cooling	Digital control	Returning air temperature sensor (S1)	1 speed	 CFG
75	4-pipe	2-stage heating	1-stage cooling	Digital control	Returning air temperature sensor (S1)	2 speeds	 CFG
76	4-pipe	2-stage heating	1-stage cooling	Digital control	Returning air temperature sensor (S1)	3 speeds	 CFG
77	4-pipe	2-stage heating	1-stage cooling	Digital control	Temperature from Modbus network	Analog control	 CFG
78	4-pipe	2-stage heating	1-stage cooling	Digital control	Temperature from Modbus network	1 speed	 CFG
79	4-pipe	2-stage heating	1-stage cooling	Digital control	Temperature from Modbus network	2 speeds	 CFG
80	4-pipe	2-stage heating	1-stage cooling	Digital control	Temperature from Modbus network	3 speeds	 CFG
81	4-pipe	2-stage heating	1-stage cooling	Analog control	iSMA-B-LP/Touch Point/FP room panel	Analog control	 CFG
82	4-pipe	2-stage heating	1-stage cooling	Analog control	iSMA-B-LP/Touch Point/FP room panel	1 speed	 CFG
83	4-pipe	2-stage heating	1-stage cooling	Analog control	iSMA-B-LP/Touch Point/FP room panel	2 speeds	 CFG








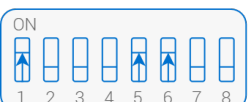


DIP Switch	1	2	3	4	5 & 6	7 & 8	
84	4-pipe	2-stage heating	1-stage cooling	Analog control	iSMA-B-LP/Touch Point/FP room panel	3 speeds	 ON 1 2 3 4 5 6 7 8 CFG
85	4-pipe	2-stage heating	1-stage cooling	Analog control	Room sensor (SI3)	Analog control	 ON 1 2 3 4 5 6 7 8 CFG
86	4-pipe	2-stage heating	1-stage cooling	Analog control	Room sensor (SI3)	1 speed	 ON 1 2 3 4 5 6 7 8 CFG
87	4-pipe	2-stage heating	1-stage cooling	Analog control	Room sensor (SI3)	2 speeds	 ON 1 2 3 4 5 6 7 8 CFG
88	4-pipe	2-stage heating	1-stage cooling	Analog control	Room sensor (SI3)	3 speeds	 ON 1 2 3 4 5 6 7 8 CFG
89	4-pipe	2-stage heating	1-stage cooling	Analog control	Returning air temperature sensor (SI1)	Analog control	 ON 1 2 3 4 5 6 7 8 CFG
90	4-pipe	2-stage heating	1-stage cooling	Analog control	Returning air temperature sensor (SI1)	1 speed	 ON 1 2 3 4 5 6 7 8 CFG
91	4-pipe	2-stage heating	1-stage cooling	Analog control	Returning air temperature sensor (SI1)	2 speeds	 ON 1 2 3 4 5 6 7 8 CFG
92	4-pipe	2-stage heating	1-stage cooling	Analog control	Returning air temperature sensor (SI1)	3 speeds	 ON 1 2 3 4 5 6 7 8 CFG
93	4-pipe	2-stage heating	1-stage cooling	Analog control	Temperature from Modbus network	Analog control	 ON 1 2 3 4 5 6 7 8 CFG


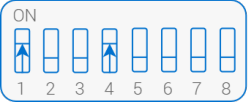


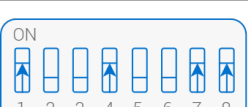



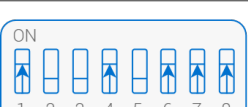

DIP Switch	1	2	3	4	5 & 6	7 & 8	
94	4-pipe	2-stage heating	1-stage cooling	Analog control	Temperature from Modbus network	1 speed	
95	4-pipe	2-stage heating	1-stage cooling	Analog control	Temperature from Modbus network	2 speeds	
96	4-pipe	2-stage heating	1-stage cooling	Analog control	Temperature from Modbus network	3 speeds	
97	4-pipe	2-stage heating	2-stage cooling	Digital control	iSMA-B-LP/Touch Point/FP room panel	Analog control	
98	4-pipe	2-stage heating	2-stage cooling	Digital control	iSMA-B-LP/Touch Point/FP room panel	1 speed	
99	4-pipe	2-stage heating	2-stage cooling	Digital control	iSMA-B-LP/Touch Point/FP room panel	2 speeds	
100	4-pipe	2-stage heating	2-stage cooling	Digital control	iSMA-B-LP/Touch Point/FP room panel	3 speeds	
101	4-pipe	2-stage heating	2-stage cooling	Digital control	Room sensor (SI3)	Analog control	
102	4-pipe	2-stage heating	2-stage cooling	Digital control	Room sensor (SI3)	1 speed	
103	4-pipe	2-stage heating	2-stage cooling	Digital control	Room sensor (SI3)	2 speeds	











DIP Switch	1	2	3	4	5 & 6	7 & 8	
104	4-pipe	2-stage heating	2-stage cooling	Digital control	Room sensor (S13)	3 speeds	
105	4-pipe	2-stage heating	2-stage cooling	Digital control	Returning air temperature sensor (S1)	Analog control	
106	4-pipe	2-stage heating	2-stage cooling	Digital control	Returning air temperature sensor (S1)	1 speed	
107	4-pipe	2-stage heating	2-stage cooling	Digital control	Returning air temperature sensor (S1)	2 speeds	
108	4-pipe	2-stage heating	2-stage cooling	Digital control	Returning air temperature sensor (S1)	3 speeds	
109	4-pipe	2-stage heating	2-stage cooling	Digital control	Temperature from Modbus network	Analog control	
110	4-pipe	2-stage heating	2-stage cooling	Digital control	Temperature from Modbus network	1 speed	
111	4-pipe	2-stage heating	2-stage cooling	Digital control	Temperature from Modbus network	2 speeds	
112	4-pipe	2-stage heating	2-stage cooling	Digital control	Temperature from Modbus network	3 speeds	
113	4-pipe	2-stage heating	2-stage cooling	Analog control	iSMA-B-LP/Touch Point/FP room panel	Analog control	











DIP Switch	1	2	3	4	5 & 6	7 & 8	
114	4-pipe	2-stage heating	2-stage cooling	Analog control	iSMA-B-LP/Touch Point/FP room panel	1 speed	
115	4-pipe	2-stage heating	2-stage cooling	Analog control	iSMA-B-LP/Touch Point/FP room panel	2 speeds	
116	4-pipe	2-stage heating	2-stage cooling	Analog control	iSMA-B-LP/Touch Point/FP room panel	3 speeds	
117	4-pipe	2-stage heating	2-stage cooling	Analog control	Room sensor (SI3)	Analog control	
118	4-pipe	2-stage heating	2-stage cooling	Analog control	Room sensor (SI3)	1 speed	
119	4-pipe	2-stage heating	2-stage cooling	Analog control	Room sensor (SI3)	2 speeds	
120	4-pipe	2-stage heating	2-stage cooling	Analog control	Room sensor (SI3)	3 speeds	
121	4-pipe	2-stage heating	2-stage cooling	Analog control	Returning air temperature sensor (SI1)	Analog control	
122	4-pipe	2-stage heating	2-stage cooling	Analog control	Returning air temperature sensor (SI1)	1 speed	
123	4-pipe	2-stage heating	2-stage cooling	Analog control	Returning air temperature sensor (SI1)	2 speeds	








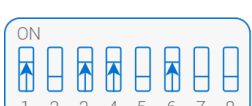


DIP Switch	1	2	3	4	5 & 6	7 & 8	
124	4-pipe	2-stage heating	2-stage cooling	Analog control	Returning air temperature sensor (S1)	3 speeds	
125	4-pipe	2-stage heating	2-stage cooling	Analog control	Temperature from Modbus network	Analog control	
126	4-pipe	2-stage heating	2-stage cooling	Analog control	Temperature from Modbus network	1 speed	
127	4-pipe	2-stage heating	2-stage cooling	Analog control	Temperature from Modbus network	2 speeds	
128	4-pipe	2-stage heating	2-stage cooling	Analog control	Temperature from Modbus network	3 speeds	
129	2-pipe	1-stage heating	1-stage cooling	Digital control	iSMA-B-LP/Touch Point/FP room panel	Analog control	
130	2-pipe	1-stage heating	1-stage cooling	Digital control	iSMA-B-LP/Touch Point/FP room panel	1 speed	
131	2-pipe	1-stage heating	1-stage cooling	Digital control	iSMA-B-LP/Touch Point/FP room panel	2 speeds	
132	2-pipe	1-stage heating	1-stage cooling	Digital control	iSMA-B-LP/Touch Point/FP room panel	3 speeds	
133	2-pipe	1-stage heating	1-stage cooling	Digital control	Room sensor (S13)	Analog control	




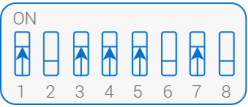



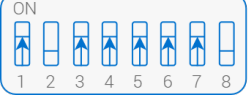


DIP Switch	1	2	3	4	5 & 6	7 & 8	
134	2-pipe	1-stage heating	1-stage cooling	Digital control	Room sensor (SI3)	1 speed	 CFG
135	2-pipe	1-stage heating	1-stage cooling	Digital control	Room sensor (SI3)	2 speeds	 CFG
136	2-pipe	1-stage heating	1-stage cooling	Digital control	Room sensor (SI3)	3 speeds	 CFG
137	2-pipe	1-stage heating	1-stage cooling	Digital control	Returning air temperature sensor (SI1)	Analog control	 CFG
138	2-pipe	1-stage heating	1-stage cooling	Digital control	Returning air temperature sensor (SI1)	1 speed	 CFG
139	2-pipe	1-stage heating	1-stage cooling	Digital control	Returning air temperature sensor (SI1)	2 speeds	 CFG
140	2-pipe	1-stage heating	1-stage cooling	Digital control	Returning air temperature sensor (SI1)	3 speeds	 CFG
141	2-pipe	1-stage heating	1-stage cooling	Digital control	Temperature from Modbus network	Analog control	 CFG
142	2-pipe	1-stage heating	1-stage cooling	Digital control	Temperature from Modbus network	1 speed	 CFG
143	2-pipe	1-stage heating	1-stage cooling	Digital control	Temperature from Modbus network	2 speeds	 CFG









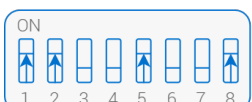
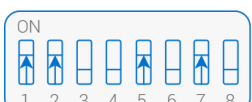
DIP Switch	1	2	3	4	5 & 6	7 & 8	
144	2-pipe	1-stage heating	1-stage cooling	Digital control	Temperature from Modbus network	3 speeds	 CFG
145	2-pipe	1-stage heating	1-stage cooling	Analog control	iSMA-B-LP/Touch Point/FP room panel	Analog control	 CFG
146	2-pipe	1-stage heating	1-stage cooling	Analog control	iSMA-B-LP/Touch Point/FP room panel	1 speed	 CFG
147	2-pipe	1-stage heating	1-stage cooling	Analog control	iSMA-B-LP/Touch Point/FP room panel	2 speeds	 CFG
148	2-pipe	1-stage heating	1-stage cooling	Analog control	iSMA-B-LP/Touch Point/FP room panel	3 speeds	 CFG
149	2-pipe	1-stage heating	1-stage cooling	Analog control	Room sensor (SI3)	Analog control	 CFG
150	2-pipe	1-stage heating	1-stage cooling	Analog control	Room sensor (SI3)	1 speed	 CFG
151	2-pipe	1-stage heating	1-stage cooling	Analog control	Room sensor (SI3)	2 speeds	 CFG
152	2-pipe	1-stage heating	1-stage cooling	Analog control	Room sensor (SI3)	3 speeds	 CFG
153	2-pipe	1-stage heating	1-stage cooling	Analog control	Returning air temperature sensor (SI1)	Analog control	 CFG









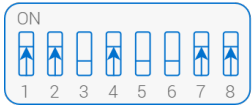

DIP Switch	1	2	3	4	5 & 6	7 & 8	
154	2-pipe	1-stage heating	1-stage cooling	Analog control	Returning air temperature sensor (S1)	1 speed	
155	2-pipe	1-stage heating	1-stage cooling	Analog control	Returning air temperature sensor (S1)	2 speeds	
156	2-pipe	1-stage heating	1-stage cooling	Analog control	Returning air temperature sensor (S1)	3 speeds	
157	2-pipe	1-stage heating	1-stage cooling	Analog control	Temperature from Modbus network	Analog control	
158	2-pipe	1-stage heating	1-stage cooling	Analog control	Temperature from Modbus network	1 speed	
159	2-pipe	1-stage heating	1-stage cooling	Analog control	Temperature from Modbus network	2 speeds	
160	2-pipe	1-stage heating	1-stage cooling	Analog control	Temperature from Modbus network	3 speeds	
161	2-pipe	1-stage heating	2-stage cooling	Digital control	iSMA-B-LP/Touch Point/FP room panel	Analog control	
162	2-pipe	1-stage heating	2-stage cooling	Digital control	iSMA-B-LP/Touch Point/FP room panel	1 speed	
163	2-pipe	1-stage heating	2-stage cooling	Digital control	iSMA-B-LP/Touch Point/FP room panel	2 speeds	

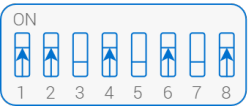


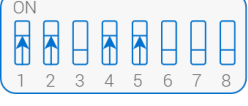
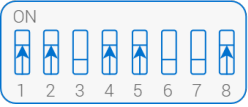

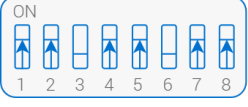
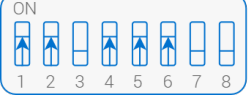
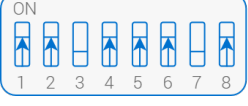
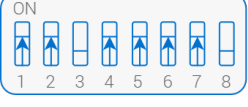
DIP Switch	1	2	3	4	5 & 6	7 & 8	
164	2-pipe	1-stage heating	2-stage cooling	Digital control	iSMA-B-LP/Touch Point/FP room panel	3 speeds	
165	2-pipe	1-stage heating	2-stage cooling	Digital control	Room sensor (SI3)	Analog control	
166	2-pipe	1-stage heating	2-stage cooling	Digital control	Room sensor (SI3)	1 speed	
167	2-pipe	1-stage heating	2-stage cooling	Digital control	Room sensor (SI3)	2 speeds	
168	2-pipe	1-stage heating	2-stage cooling	Digital control	Room sensor (SI3)	3 speeds	
169	2-pipe	1-stage heating	2-stage cooling	Digital control	Returning air temperature sensor (SI1)	Analog control	
170	2-pipe	1-stage heating	2-stage cooling	Digital control	Returning air temperature sensor (SI1)	1 speed	
171	2-pipe	1-stage heating	2-stage cooling	Digital control	Returning air temperature sensor (SI1)	2 speeds	
172	2-pipe	1-stage heating	2-stage cooling	Digital control	Returning air temperature sensor (SI1)	3 speeds	
173	2-pipe	1-stage heating	2-stage cooling	Digital control	Temperature from Modbus network	Analog control	

DIP Switch	1	2	3	4	5 & 6	7 & 8	
174	2-pipe	1-stage heating	2-stage cooling	Digital control	Temperature from Modbus network	1 speed	 CFG
175	2-pipe	1-stage heating	2-stage cooling	Digital control	Temperature from Modbus network	2 speeds	 CFG
176	2-pipe	1-stage heating	2-stage cooling	Digital control	Temperature from Modbus network	3 speeds	 CFG
177	2-pipe	1-stage heating	2-stage cooling	Analog control	iSMA-B-LP/Touch Point/FP room panel	Analog control	 CFG
178	2-pipe	1-stage heating	2-stage cooling	Analog control	iSMA-B-LP/Touch Point/FP room panel	1 speed	 CFG
179	2-pipe	1-stage heating	2-stage cooling	Analog control	iSMA-B-LP/Touch Point/FP room panel	2 speeds	 CFG
180	2-pipe	1-stage heating	2-stage cooling	Analog control	iSMA-B-LP/Touch Point/FP room panel	3 speeds	 CFG
181	2-pipe	1-stage heating	2-stage cooling	Analog control	Room sensor (SI3)	Analog control	 CFG
182	2-pipe	1-stage heating	2-stage cooling	Analog control	Room sensor (SI3)	1 speed	 CFG
183	2-pipe	1-stage heating	2-stage cooling	Analog control	Room sensor (SI3)	2 speeds	 CFG











DIP Switch	1	2	3	4	5 & 6	7 & 8	
184	2-pipe	1-stage heating	2-stage cooling	Analog control	Room sensor (S13)	3 speeds	
185	2-pipe	1-stage heating	2-stage cooling	Analog control	Returning air temperature sensor (S1)	Analog control	
186	2-pipe	1-stage heating	2-stage cooling	Analog control	Returning air temperature sensor (S1)	1 speed	
187	2-pipe	1-stage heating	2-stage cooling	Analog control	Returning air temperature sensor (S1)	2 speeds	
188	2-pipe	1-stage heating	2-stage cooling	Analog control	Returning air temperature sensor (S1)	3 speeds	
189	2-pipe	1-stage heating	2-stage cooling	Analog control	Temperature from Modbus network	Analog control	
190	2-pipe	1-stage heating	2-stage cooling	Analog control	Temperature from Modbus network	1 speed	
191	2-pipe	1-stage heating	2-stage cooling	Analog control	Temperature from Modbus network	2 speeds	
192	2-pipe	1-stage heating	2-stage cooling	Analog control	Temperature from Modbus network	3 speeds	
193	2-pipe	2-stage heating	1-stage cooling	Digital control	iSMA-B-LP/Touch Point/FP room panel	Analog control	

DIP Switch	1	2	3	4	5 & 6	7 & 8	
194	2-pipe	2-stage heating	1-stage cooling	Digital control	iSMA-B-LP/Touch Point/FP room panel	1 speed	 CFG
195	2-pipe	2-stage heating	1-stage cooling	Digital control	iSMA-B-LP/Touch Point/FP room panel	2 speeds	 CFG
196	2-pipe	2-stage heating	1-stage cooling	Digital control	iSMA-B-LP/Touch Point/FP room panel	3 speeds	 CFG
197	2-pipe	2-stage heating	1-stage cooling	Digital control	Room sensor (SI3)	Analog control	 CFG
198	2-pipe	2-stage heating	1-stage cooling	Digital control	Room sensor (SI3)	1 speed	 CFG
199	2-pipe	2-stage heating	1-stage cooling	Digital control	Room sensor (SI3)	2 speeds	 CFG
200	2-pipe	2-stage heating	1-stage cooling	Digital control	Room sensor (SI3)	3 speeds	 CFG
201	2-pipe	2-stage heating	1-stage cooling	Digital control	Returning air temperature sensor (SI1)	Analog control	 CFG
202	2-pipe	2-stage heating	1-stage cooling	Digital control	Returning air temperature sensor (SI1)	1 speed	 CFG
203	2-pipe	2-stage heating	1-stage cooling	Digital control	Returning air temperature sensor (SI1)	2 speeds	 CFG

DIP Switch	1	2	3	4	5 & 6	7 & 8	
204	2-pipe	2-stage heating	1-stage cooling	Digital control	Returning air temperature sensor (S1)	3 speeds	
205	2-pipe	2-stage heating	1-stage cooling	Digital control	Temperature from Modbus network	Analog control	
206	2-pipe	2-stage heating	1-stage cooling	Digital control	Temperature from Modbus network	1 speed	
207	2-pipe	2-stage heating	1-stage cooling	Digital control	Temperature from Modbus network	2 speeds	
208	2-pipe	2-stage heating	1-stage cooling	Digital control	Temperature from Modbus network	3 speeds	
209	2-pipe	2-stage heating	1-stage cooling	Analog control	iSMA-B-LP/Touch Point/FP room panel	Analog control	
210	2-pipe	2-stage heating	1-stage cooling	Analog control	iSMA-B-LP/Touch Point/FP room panel	1 speed	
211	2-pipe	2-stage heating	1-stage cooling	Analog control	iSMA-B-LP/Touch Point/FP room panel	2 speeds	
212	2-pipe	2-stage heating	1-stage cooling	Analog control	iSMA-B-LP/Touch Point/FP room panel	3 speeds	
213	2-pipe	2-stage heating	1-stage cooling	Analog control	Room sensor (S13)	Analog control	

DIP Switch	1	2	3	4	5 & 6	7 & 8	
214	2-pipe	2-stage heating	1-stage cooling	Analog control	Room sensor (SI3)	1 speed	 CFG
215	2-pipe	2-stage heating	1-stage cooling	Analog control	Room sensor (SI3)	2 speeds	 CFG
216	2-pipe	2-stage heating	1-stage cooling	Analog control	Room sensor (SI3)	3 speeds	 CFG
217	2-pipe	2-stage heating	1-stage cooling	Analog control	Returning air temperature sensor (SI1)	Analog control	 CFG
218	2-pipe	2-stage heating	1-stage cooling	Analog control	Returning air temperature sensor (SI1)	1 speed	 CFG
219	2-pipe	2-stage heating	1-stage cooling	Analog control	Returning air temperature sensor (SI1)	2 speeds	 CFG
220	2-pipe	2-stage heating	1-stage cooling	Analog control	Returning air temperature sensor (SI1)	3 speeds	 CFG
221	2-pipe	2-stage heating	1-stage cooling	Analog control	Temperature from Modbus network	Analog control	 CFG
222	2-pipe	2-stage heating	1-stage cooling	Analog control	Temperature from Modbus network	1 speed	 CFG
223	2-pipe	2-stage heating	1-stage cooling	Analog control	Temperature from Modbus network	2 speeds	 CFG

DIP Switch	1	2	3	4	5 & 6	7 & 8	
224	2-pipe	2-stage heating	1-stage cooling	Analog control	Temperature from Modbus network	3 speeds	
225	2-pipe	2-stage heating	2-stage cooling	Digital control	iSMA-B-LP/Touch Point/FP room panel	Analog control	
226	2-pipe	2-stage heating	2-stage cooling	Digital control	iSMA-B-LP/Touch Point/FP room panel	1 speed	
227	2-pipe	2-stage heating	2-stage cooling	Digital control	iSMA-B-LP/Touch Point/FP room panel	2 speeds	
228	2-pipe	2-stage heating	2-stage cooling	Digital control	iSMA-B-LP/Touch Point/FP room panel	3 speeds	
229	2-pipe	2-stage heating	2-stage cooling	Digital control	Room sensor (SI3)	Analog control	
230	2-pipe	2-stage heating	2-stage cooling	Digital control	Room sensor (SI3)	1 speed	
231	2-pipe	2-stage heating	2-stage cooling	Digital control	Room sensor (SI3)	2 speeds	
232	2-pipe	2-stage heating	2-stage cooling	Digital control	Room sensor (SI3)	3 speeds	
233	2-pipe	2-stage heating	2-stage cooling	Digital control	Returning air temperature sensor (SI1)	Analog control	

DIP Switch	1	2	3	4	5 & 6	7 & 8	
234	2-pipe	2-stage heating	2-stage cooling	Digital control	Returning air temperature sensor (S1)	1 speed	
235	2-pipe	2-stage heating	2-stage cooling	Digital control	Returning air temperature sensor (S1)	2 speeds	
236	2-pipe	2-stage heating	2-stage cooling	Digital control	Returning air temperature sensor (S1)	3 speeds	
237	2-pipe	2-stage heating	2-stage cooling	Digital control	Temperature from Modbus network	Analog control	
238	2-pipe	2-stage heating	2-stage cooling	Digital control	Temperature from Modbus network	1 speed	
239	2-pipe	2-stage heating	2-stage cooling	Digital control	Temperature from Modbus network	2 speeds	
240	2-pipe	2-stage heating	2-stage cooling	Digital control	Temperature from Modbus network	3 speeds	
241	2-pipe	2-stage heating	2-stage cooling	Analog control	iSMA-B-LP/Touch Point/FP room panel	Analog control	
242	2-pipe	2-stage heating	2-stage cooling	Analog control	iSMA-B-LP/Touch Point/FP room panel	1 speed	
243	2-pipe	2-stage heating	2-stage cooling	Analog control	iSMA-B-LP/Touch Point/FP room panel	2 speeds	

DIP Switch	1	2	3	4	5 & 6	7 & 8	
244	2-pipe	2-stage heating	2-stage cooling	Analog control	iSMA-B-LP/Touch Point/FP room panel	3 speeds	
245	2-pipe	2-stage heating	2-stage cooling	Analog control	Room sensor (SI3)	Analog control	
246	2-pipe	2-stage heating	2-stage cooling	Analog control	Room sensor (SI3)	1 speed	
247	2-pipe	2-stage heating	2-stage cooling	Analog control	Room sensor (SI3)	2 speeds	
248	2-pipe	2-stage heating	2-stage cooling	Analog control	Room sensor (SI3)	3 speeds	
249	2-pipe	2-stage heating	2-stage cooling	Analog control	Returning air temperature sensor (SI1)	Analog control	
250	2-pipe	2-stage heating	2-stage cooling	Analog control	Returning air temperature sensor (SI1)	1 speed	
251	2-pipe	2-stage heating	2-stage cooling	Analog control	Returning air temperature sensor (SI1)	2 speeds	
252	2-pipe	2-stage heating	2-stage cooling	Analog control	Returning air temperature sensor (SI1)	3 speeds	
253	2-pipe	2-stage heating	2-stage cooling	Analog control	Temperature from Modbus network	Analog control	




DIP Switch	1	2	3	4	5 & 6	7 & 8	
254	2-pipe	2-stage heating	2-stage cooling	Analog control	Temperature from Modbus network	1 speed	 <p>ON 1 2 3 4 5 6 7 8 CFG</p>
255	2-pipe	2-stage heating	2-stage cooling	Analog control	Temperature from Modbus network	2 speeds	 <p>ON 1 2 3 4 5 6 7 8 CFG</p>
256	2-pipe	2-stage heating	2-stage cooling	Analog control	Temperature from Modbus network	3 speeds	 <p>ON 1 2 3 4 5 6 7 8 CFG</p>

Table 8. All available DIP switch configurations